



Description

Silicon Carbide (SiC) MOSFET use a completely new technology that provide superior switching performance and higher reliability compared to Silicon. In addition, the low ON resistance and compact chip size ensure low capacitance and gate charge. Consequently, system benefits include highest efficiency, faster operating frequency, increased power density, reduced EMI, and reduced system size.

Features

- High Speed Switching with Low Capacitances
- High Blocking Voltage with Low RDS(on)
- Simple to drive with Standard Gate Drive
- 100% avalanche tested
- Maximum junction temperature of 150°C
- ROHS Compliant

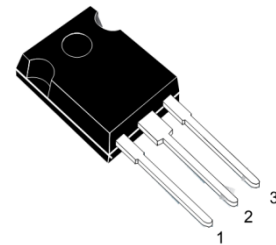

Application

- EV Charging
- DC-AC Inverters
- High Voltage DC/DC Converters
- Switch Mode Power Supplies
- Power Factor Correction Modules
- Motor Drives

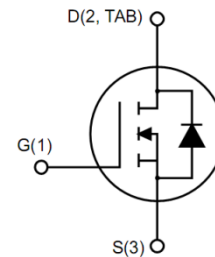

Ordering Information

| Part Number | Marking | Package | Packaging |
|---------------|---------------|---------|-----------|
| ASC60N1200MT3 | ASC60N1200MT3 | TO-247 | Tube |



ASC60N1200MT3

Absolute Maximum Ratings($T_c=25^\circ\text{C}$)

| Symbol | Parameter | Value | Unit |
|----------------|---|-------------|------------------|
| V_{DS} | Drain-Source Voltage | 1200 | V |
| I_D | Drain Current(continuous)at $T_c=25^\circ\text{C}$ | 60 | A |
| I_D | Drain Current(continuous)at $T_c=100^\circ\text{C}$ | 40 | A |
| I_{DM} | Drain Current (pulsed) | 160 | A |
| V_{GS} | Gate-Source Voltage | -10/+22 | V |
| P_D | Power Dissipation $T_c = 25^\circ\text{C}$ | 328 | W |
| T_J, T_{stg} | Junction and Storage Temperature Range | -55 to +150 | $^\circ\text{C}$ |

Electrical Characteristics($T_J = 25^\circ\text{C}$ unless otherwise specified)

Typical Performance-Static

| Symbol | Parameter | Test Conditions | Min. | Typ. | Max. | Unit |
|--------------|-----------------------------------|---|------|------|------|------------------|
| BV_{DS} | Drain-source Breakdown Voltage | $I_D=250\mu\text{A}, V_{GS}=0\text{V}$ | 1200 | | | V |
| I_{DSS} | Zero Gate Voltage Drain Current | $V_{DS}=1200\text{V}, V_{GS}=0\text{V}, T_J=25^\circ\text{C}$ | | | 100 | μA |
| I_{GSS} | Gate-body Leakage Current | $V_{GS}=20\text{V}, V_{DS}=0\text{V}$ | | | 250 | nA |
| $V_{GS(th)}$ | Gate Threshold Voltage | $V_{DS}=V_{GS}, I_D=10\text{mA}$ | 2 | | 4 | V |
| $R_{DS(on)}$ | Static Drain-source On Resistance | $V_{GS}=20\text{V}, I_D=40\text{A}$ | | 33 | 45 | $\text{m}\Omega$ |
| R_G | Gate Resistance | $V_{GS}=0\text{V}, f=1\text{MHz}$ | | 5 | | Ω |

Typical Performance-Dynamic

| | | | | | | |
|--------------|------------------------------|---|--|------|--|----|
| C_{iss} | Input Capacitance | $V_{DS}=800\text{V}, f=1\text{MHz}, V_{GS}=0\text{V}$ | | 1950 | | pF |
| C_{oss} | Output Capacitance | | | 185 | | pF |
| C_{riss} | Reverse Transfer Capacitance | | | 28 | | pF |
| Q_g | Total Gate Charge | $V_{DS}=800\text{V}, I_D=40\text{A}, V_{GS}=0\sim 20\text{V}$ | | 126 | | nC |
| Q_{gs} | Gate-source Charge | | | 20 | | nC |
| Q_{gd} | Gate-Drain Charge | | | 38 | | nC |
| $t_{d(on)}$ | Turn-on Delay Time | $V_{DD}=800\text{V}, I_D=40\text{A}, V_{GS}=-5\text{V}\sim 20\text{V}, R_G=0\Omega, R_L=40\Omega, T_J=25^\circ\text{C}$ | | 22 | | ns |
| t_r | Rise Time | | | 56 | | ns |
| $t_{d(off)}$ | Turn-off Delay Time | | | 32 | | ns |
| t_f | Fall Time | | | 35 | | ns |

Typical Performance-Reverse Diode

| Symbol | Parameter | Test Conditions | Min. | Typ. | Max. | Unit |
|------------------|-------------------------------|---|------|------|------|------|
| V _{FSD} | Forward Voltage | V _{GS} =0V, I _F =30A, T _J =25°C | 3 | | 6 | V |
| | | V _{GS} =0V, I _F =30A, T _J =150°C | 3 | | 6 | V |
| t _{rr} | Reverse Recovery Time | V _{GS} =0 V, I _F =30 A, V _R =800 V, di/dt= 2000 A/us | | 58 | | ns |
| Q _{rr} | Reverse Recovery Charge | | | 287 | | nC |
| I _{rrm} | Peak Reverse Recovery Current | | | 18 | | A |

Thermal Characteristics

| Symbol | Parameter | Value. | Unit |
|------------------|--------------------------------------|--------|------|
| R _{θJC} | Thermal Resistance, Junction-to-Case | 0.38 | °C/W |
| R _{θJA} | Thermal Resistance, Junction-to-Case | 40 | °C/W |

The values are based on the junction-to case thermal impedance which is measured with the device mounted to a large heat sink assuming maximum junction temperature of T_J(max)=150°C

Electrical Characteristics (25°C unless noted)
Figure 1: Output characteristics ($T_J = 25^\circ\text{C}$)

Figure 2: Output characteristics ($T_J = 150^\circ\text{C}$)

Figure 3: Transfer characteristics

Figure 5: Power dissipation

Figure 4 Normalized BVDSS vs. Temperature

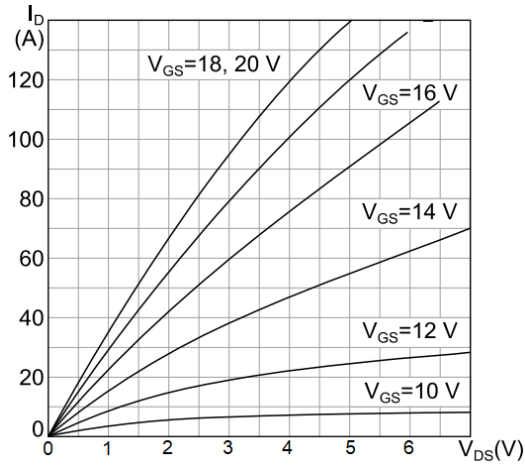
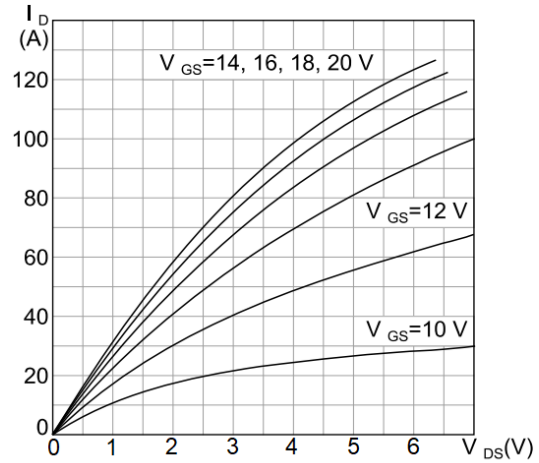
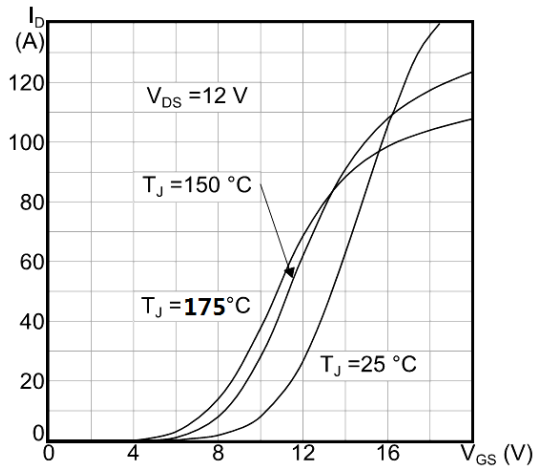
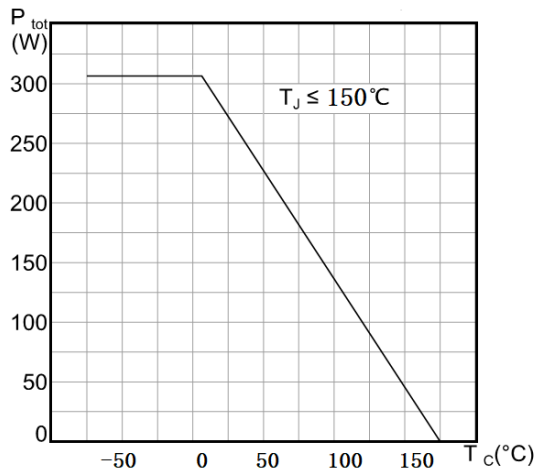
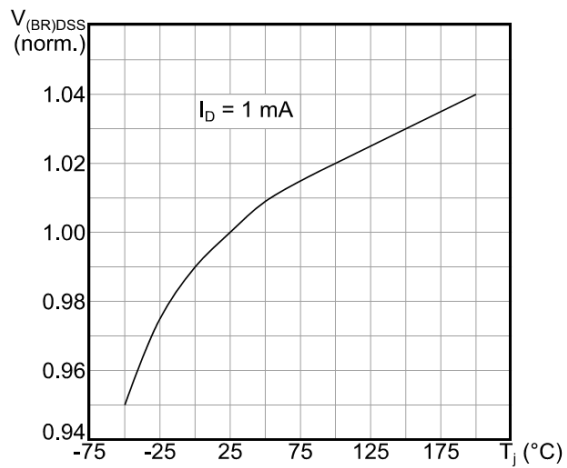
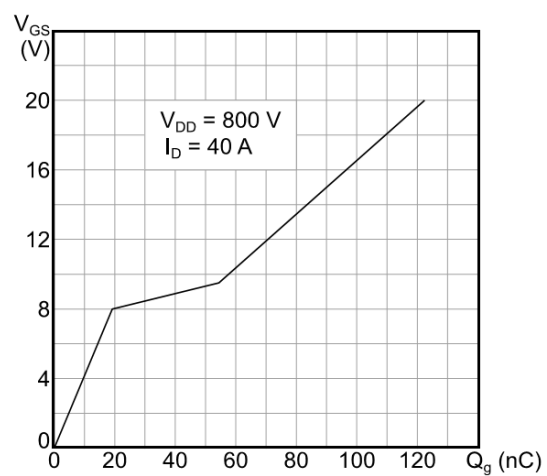
Figure 6: Gate charge vs gate-source voltage

Figure 7: Capacitance variations

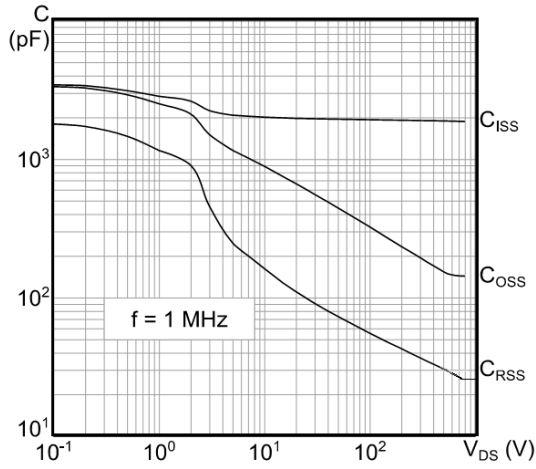

Figure 8: Switching energy vs. drain current

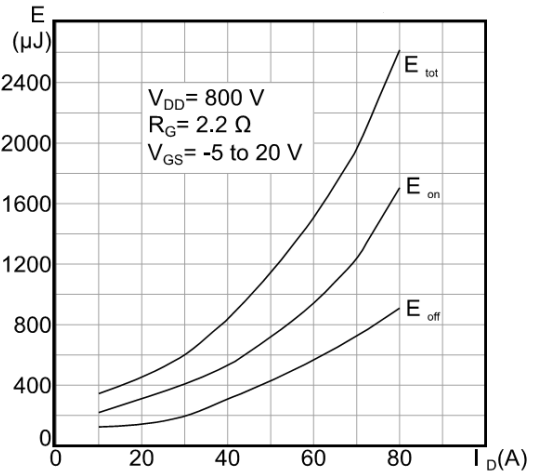

Figure 9: Normalized V_{th} vs. T_J

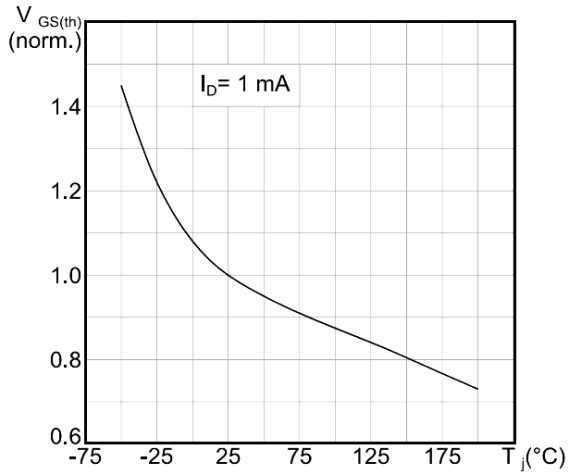

Figure 10: Normalized R_{DS(on)} vs. T_J

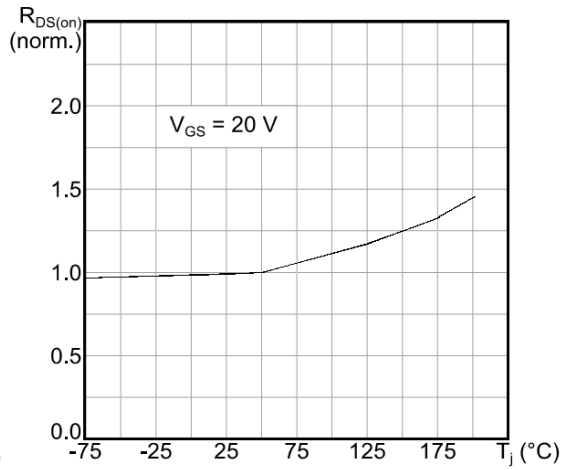

Figure 11: Body diode characteristics (T_J = 25 °C)

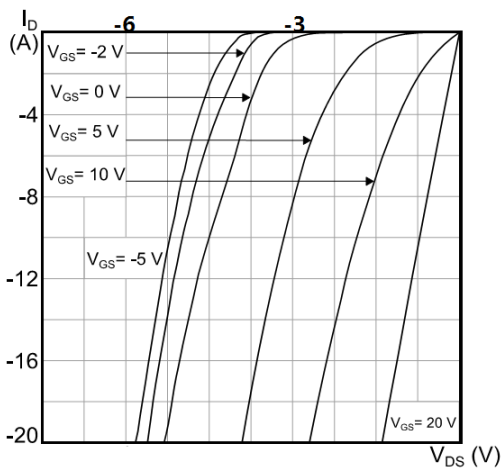

Figure 12: Body diode characteristics (T_J = 150 °C)

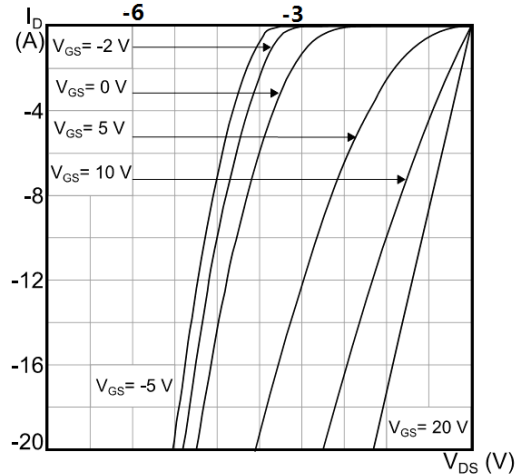

Figure 13: Safe operating area

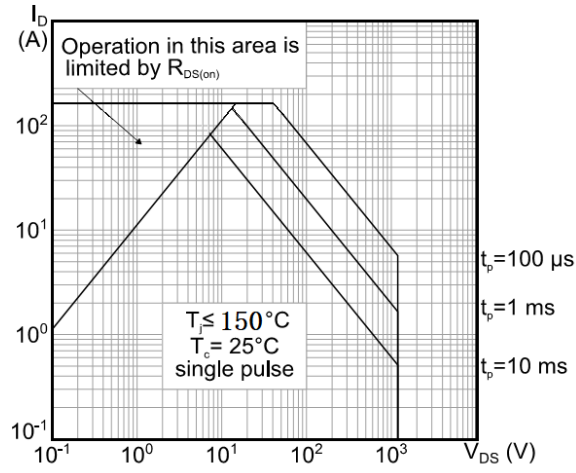

Figure 14: Continuous Ids VS Tc

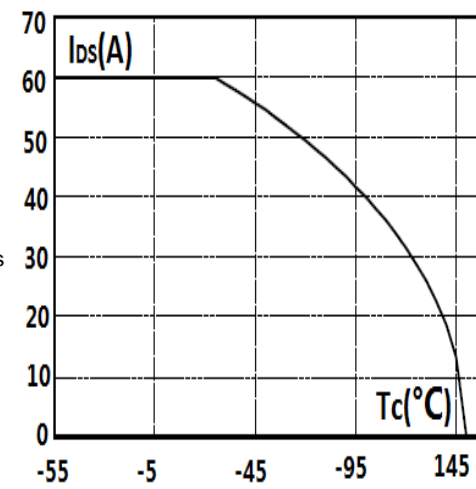
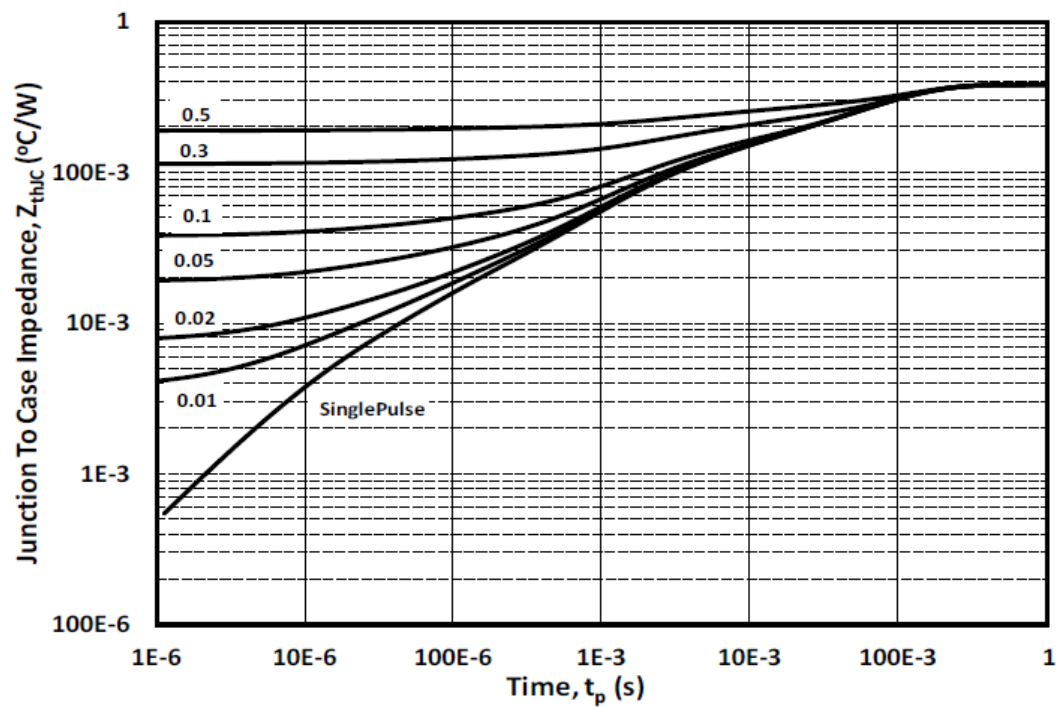
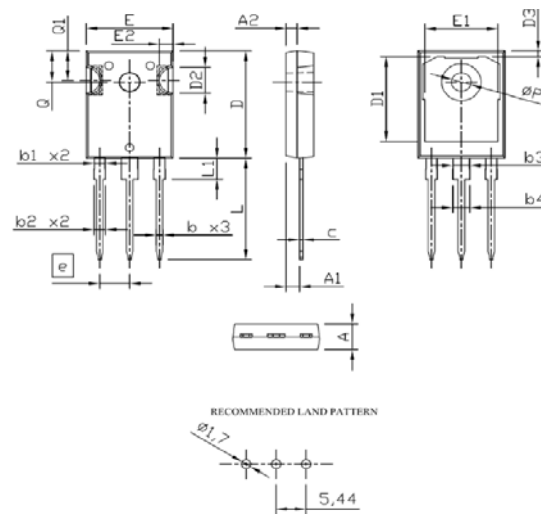

Figure 15: Thermal impedance



Package Drawing:

Dimensions (UNIT: mm)

| SYMBDLS | DIMENSIONS IN MILLIMETERS | | | DIMENSIONS IN INCHES | | |
|---------|---------------------------|-------|-------|----------------------|-------|-------|
| | MIN | NOM | MAX | MIN | NOM | MAX |
| A | 4.90 | 5.00 | 5.10 | 0.193 | 0.197 | 0.201 |
| A1 | 2.31 | 2.42 | 2.52 | 0.091 | 0.095 | 0.099 |
| A2 | 1.90 | 2.00 | 2.10 | 0.075 | 0.079 | 0.083 |
| b | 1.16 | 1.22 | 1.27 | 0.046 | 0.048 | 0.050 |
| b1 | 1.96 | 2.02 | 2.07 | 0.078 | 0.080 | 0.081 |
| b2 | 2.00 | 2.10 | 2.20 | 0.079 | 0.083 | 0.087 |
| b3 | 2.96 | 3.02 | 3.07 | 0.117 | 0.119 | 0.121 |
| b4 | 3.00 | 3.10 | 3.20 | 0.118 | 0.122 | 0.126 |
| C | 0.59 | 0.62 | 0.66 | 0.023 | 0.024 | 0.026 |
| D | 20.90 | 21.00 | 21.10 | 0.823 | 0.827 | 0.831 |
| D1 | 16.25 | 16.55 | 16.85 | 0.640 | 0.652 | 0.663 |
| D2 | 5.00 TYP | | | 0.197 TYP | | |
| D3 | 1.05 | 1.20 | 1.35 | 0.041 | 0.047 | 0.053 |
| e | 5.44 BSC | | | 0.214 BSC | | |
| E | 15.70 | 15.80 | 15.90 | 0.618 | 0.622 | 0.626 |
| E1 | 13.06 | 13.26 | 13.50 | 0.514 | 0.522 | 0.530 |
| E2 | 2.50 TYP | | | 0.098 TYP | | |
| L | 19.72 | 19.92 | 20.12 | 0.776 | 0.784 | 0.792 |
| L1 | — | — | 4.30 | — | — | 0.169 |
| Q | 6.15 BSC | | | 0.242BSC | | |
| Q1 | 5.60 | 5.80 | 6.00 | 0.220 | 0.228 | 0.236 |
| ØP | 3.55 | 3.60 | 3.70 | 0.140 | 0.142 | 0.146 |