



The Future of Analog IC Technology®

EV4008-S-00A

High-Brightness High-Current Accuracy WLED Controller

DESCRIPTION

The EV4008-S-00A is designed to demonstrate the capabilities of MP4008. The MP4008 is a current mode controller designed for driving the high brightness Light Emitting Diodes (LEDs) with wide input voltage 9V-28V. It can be used both in Boost and SEPIC topologies.

With a 20-48V power supply PVIN and a 9-28V IC supply for MP4008, The evaluation board can drive a single LED string with the LED current regulated to 350mA and VLED voltage up to 70V. Apply a PWM dimming signal to do PWM dimming. The Over-Voltage protection, short LED protection, short inductor/diode protection and over current protection are integrated.

ELECTRICAL SPECIFICATION

| Parameter | Symbol | Value | Units |
|-------------------------------|-------------------|---------|-------|
| Power Supply Voltage | PVIN | 20-48 | V |
| IC Supply Voltage | VIN | 9-28 | V |
| LED Voltage | V _{LED} | 70(max) | V |
| LED Current | I _{LED} | 350 | mA |
| Switching Frequency | fs | 180 | kHz |
| Over Voltage Protection Point | V _{OV} P | 81 | V |

FEATURES

- Constant-current WLED Driver Controller
- 280mV Feedback Voltage with ±1.8% Accuracy
- 9V-28V Input Voltage
- Leading Edge Blanking for Current Sense
- Frequency Fixed 180kHz
- Fast PWM Dimming
- Soft Start
- Over Voltage Protection
- Short LED Protection
- Short Output Protection
- Over Current Protection
- Short Inductor/Diode Protection
- VIN UVLO
- Thermal Shutdown
- Available in SOIC-8 package

APPLICATIONS

- LCD Backlighting
- DC/DC LED Driver
- General Illumination

All MPS parts are lead-free, halogen free, and adhere to the RoHS directive. For MPS green status, please visit MPS website under Quality Assurance.

"MPS" and "The Future of Analog IC Technology" are Registered Trademarks of Monolithic Power Systems, Inc.



High Voltage

Warning: Although this board is designed to satisfy safety requirements, the engineering prototype has not been agency approved. Therefore, all testing should be performed using an isolation transformer to provide the AC input to the prototype board.

EV4008-S-00A EVALUATION BOARD

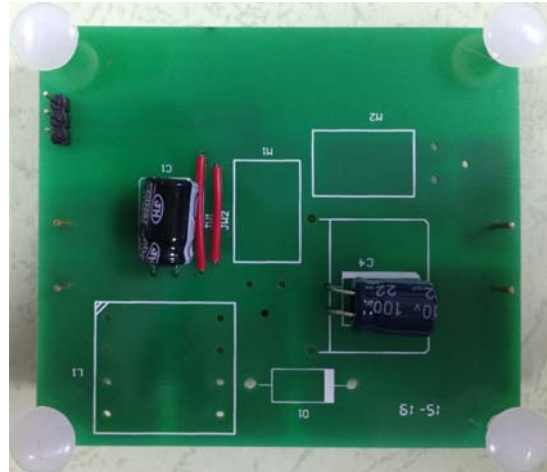

(L x W x H) 7.5cm x 6.5cm x 1.5cm

| Board Number | MPS IC Number |
|--------------|---------------|
| EV4008-S-00A | MP4008GS |

EVALUATION BOARD SCHEMATIC

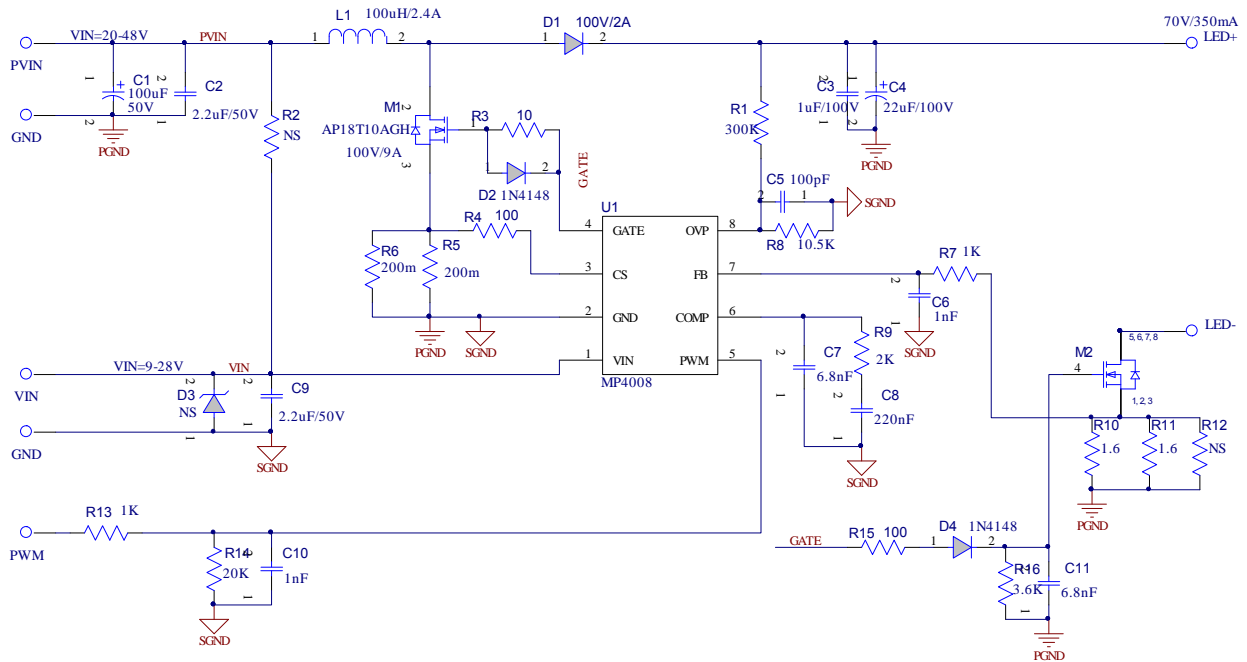

BILL OF MATERIALS

| Qty | Ref | Value | Description | Package | Manufacture | Manufacture_PN |
|-----|----------|------------------|---------------------------------------|---------|--------------|--------------------|
| 1 | C1 | 100 μ F | Electrolytic Capacitor;50V | DIP | 江海 | CD287-50V100 |
| 2 | C2 | 2.2 μ F/50V | Ceramic Capacitor; 50V;X7R; 1206 | 1210 | TDK | C3225X7R1H225K |
| 1 | C3 | 1 μ F/100V | Ceramic Capacitor; 100V;X7R; 1210 | 1210 | muRata | GRM32ER72A105KA01L |
| 1 | C4 | 22 μ F/100V | Electrolytic Capacitor;100V | DIP | 江海 | CD263-100V22 |
| 1 | C5 | 100pF | Ceramic Capacitor; 50V;C0G; 0603 | 0603 | TDK | C1608COG1H101J |
| 2 | C6, C10 | 1nF | Ceramic Capacitor; 50V;X7R; 0603; | 0603 | TDK | C1608X7R1H102K |
| 2 | C7, C11 | 6.8nF | Ceramic Capacitor; 50V;X7R; 0603 | 0603 | LION | 0603B682K500T |
| 1 | C8 | 220nF | Ceramic Capacitor; 16V;X7R; 0603; | 0603 | muRata | GRM188R71C224KA01D |
| 1 | C9 | 2.2 μ F/50V | Ceramic Capacitor; 50V;X7R; 1206 | 1206 | muRata | GRM31CR71H225KA88L |
| 1 | D1 | B2100 | Shottky Diode;100V;2A; | SMB | Diodes | B2100 |
| 2 | D2, D4 | 1N4148W | Diode;75V;0.15A; | SOD-123 | Diodes | 1N4148W |
| 1 | D3 | NS | | | | |
| 2 | JR1,JR2 | 0 | Film Resistor;5% | 1206 | Yageo | RC1206JR-070R |
| 1 | L1 | 100 μ H/2.4A | Inductor;100 μ H;220m;2.4A | SMD | Würth | 74477020 |
| 1 | M1 | AP18T10AGH | Mosfet;100V;160;9.6;9 | TO-252 | APEC | AP18T10AGH |
| 1 | M2 | AM4490N | N-Channel Mosfet;100V;92;12.5; 5.2 | SO-8 | Analog Power | AM4490N |
| 1 | R1 | 300k | Resistor;1%;1/4W | 1206 | Yageo | RC1206FR-07300KL |
| 2 | R2, R12 | NS | | | | |
| 1 | R3 | 10 | Film Resistor;5%; | 0603 | Yageo | RC0603JR-0710RL |
| 2 | R4, R15 | 100 | Film Resistor;1% | 0603 | Yageo | RC0603FR-07100RL |
| 2 | R5, R6 | 200m | Film Resistor;1%; | 1206 | Yageo | RL1206FR-070R2L |
| 2 | R7, R13 | 1k | Film Resistor;5%; | 0603 | Yageo | RC0603FR-071KL |
| 1 | R8 | 10.5k | Film Resistor;1% | 0603 | Yageo | RC0603FR-0710K5L |
| 1 | R9 | 2k | Film Resistor;1%; | 0603 | Yageo | RC0603FR-072KL |
| 2 | R10, R11 | 1.6 | Film Resistor;1% | 1206 | Yageo | RC1206FR-071R6L |
| 1 | R14 | 20k | Film Resistor;1%;1/10W; | 0603 | Yageo | RC0603FR-0720KL |
| 1 | R16 | 3.6k | Film Resistor;5%;1/10W | 0603 | LIZ | CR0603JA0362G |
| 1 | U1 | MP4008GS | MP4008 | SO-8 | MPS | MP4008GS |

EVB TEST RESULTS

PVIN=20-48V, VIN = 12V, VLED= 70V, ILED=350mA, TA = 25°C, unless otherwise noted.

PWM Dimming Curve

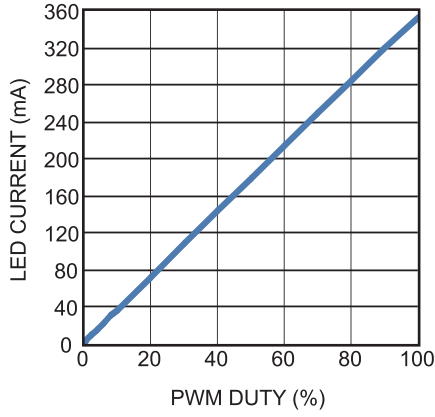

Efficiency vs. PVIN

VIN=12V, VLED=70V

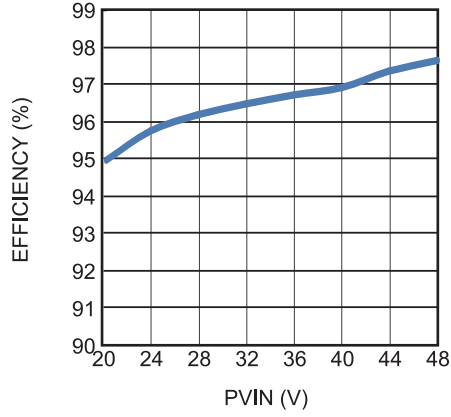

Efficiency vs. VLED

VIN=12V, PVIN=20V

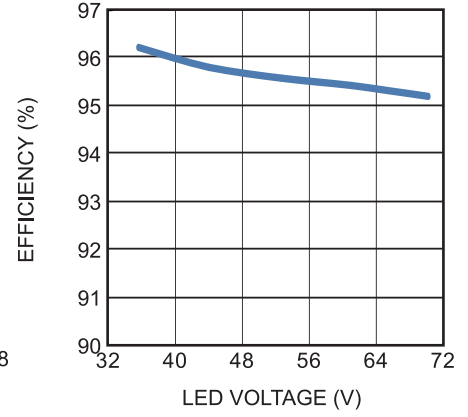

TYPICAL PERFORMANCE CHARACTERISTICS (continued)
 $V_{IN}=12V, PV_{IN}=20V, V_{LED}=70V, I_{LED}=350mA, L=100\mu H, T_A=25^\circ C$, unless otherwise noted.

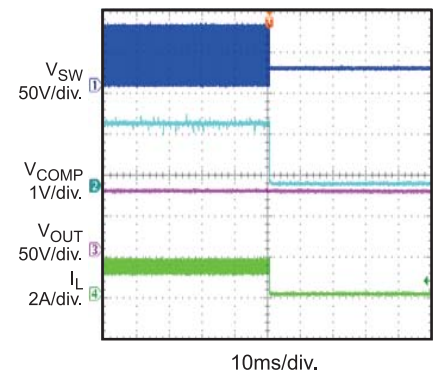
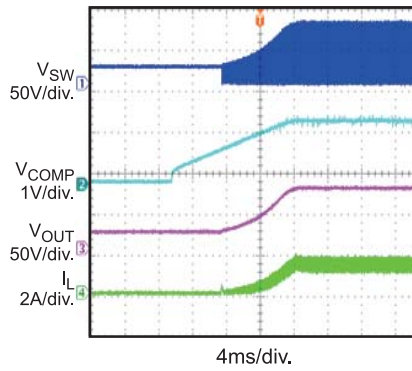
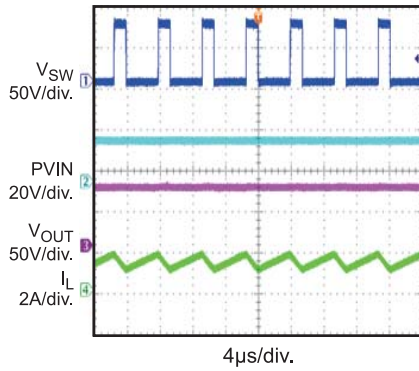
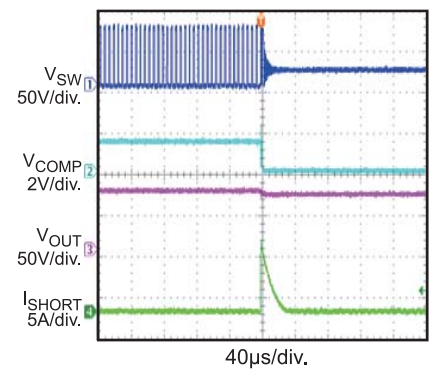
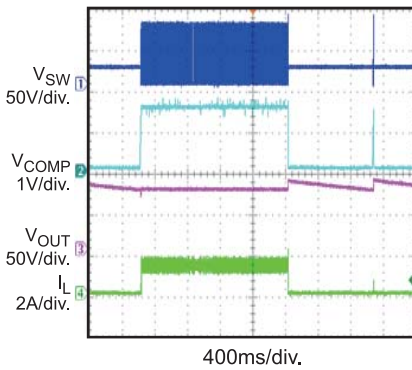
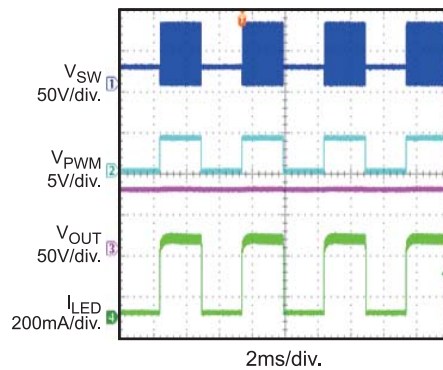
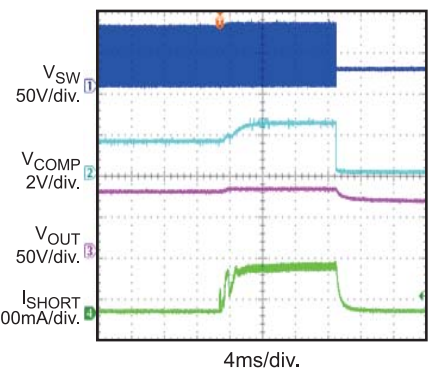
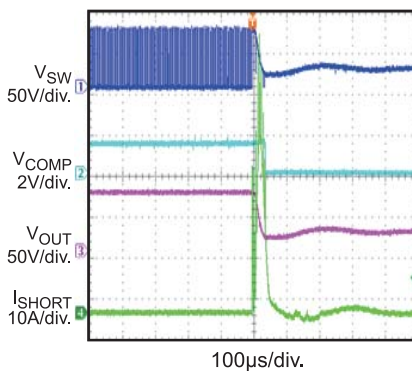
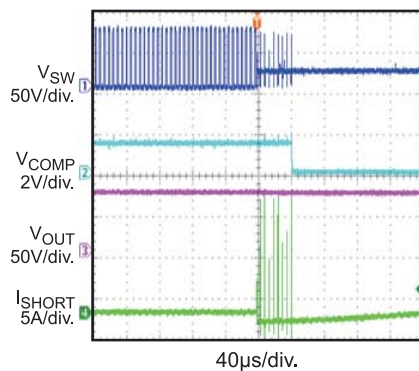
Steady State
 V_{IN} Start-Up
 V_{IN} OFF

PWM Dimming
 $f_{PWM}=200Hz, Duty=50\%$
Open-Load Protection
Short-Load Protection

Short-Inductor Protection
Short-Diode Protection
Short LED- to GND Protection

PRINTED CIRCUIT BOARD LAYOUT

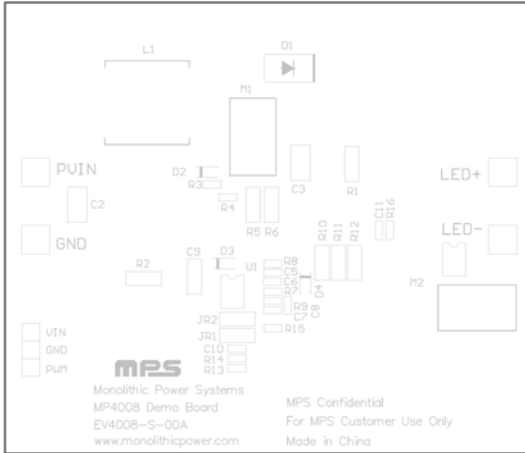

Figure 1—Top Silk Layer

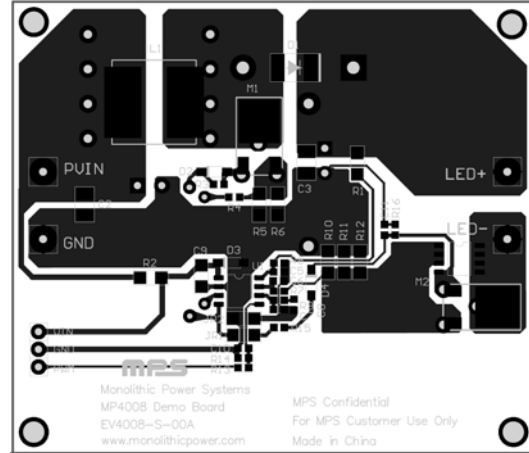

Figure 2—Top Layer

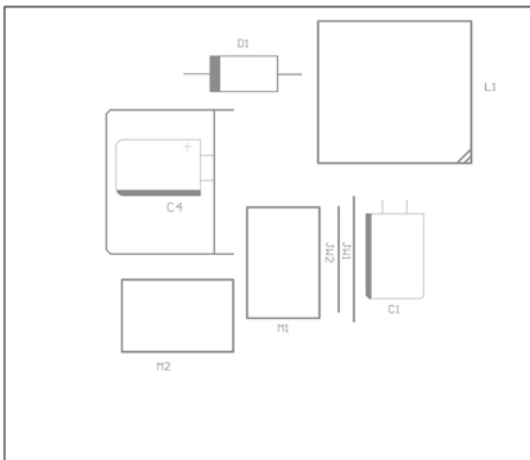

Figure 3—Bottom Silk Layer

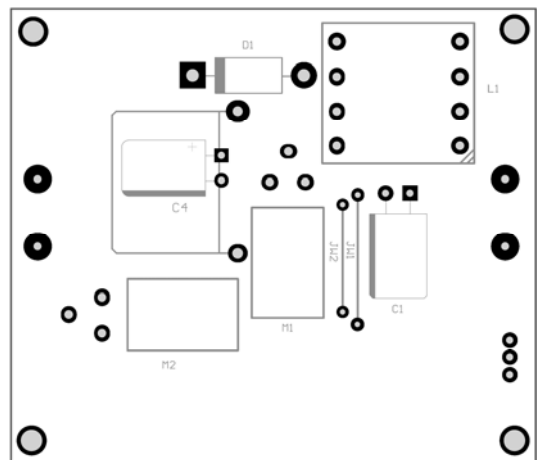

Figure 4—Bottom Layer

QUICK START GUIDE

1. Preset the LED string forward voltage to 70V, connect the anode of LED string to 'LED+' and the cathode of LED string to 'LED-';
2. Preset the PVIN supply voltage to 20-48V, turn off the power supply, connect the power supply to 'PVIN';
3. Preset the VIN supply voltage 9-28V, turn off the power supply, connect the power supply to 'VIN';
4. Connect the 'PWM' connector to the PWM dimming signal; the high level of PWM signal is in the range of 1.5V-5V, and the low level is in the range of 0-0.4V;
5. Turn on PVIN supply, set PWM signal to high level, turn on VIN supply, the LED string should be ignited.
6. To demo the PWM dimming function: connect the 'PWM' connector to an PWM signal; the frequency of the PWM signal is in the range of 100Hz to 2kHz, the high level of the PWM signal is 1.5V-5V and low level is 0-0.8V. Adjust the duty of the PWM signal; the LED current will follow the duty of the PWM dimming signal.

NOTICE: The information in this document is subject to change without notice. Please contact MPS for current specifications. Users should warrant and guarantee that third party Intellectual Property rights are not infringed upon when integrating MPS products into any application. MPS will not assume any legal responsibility for any said applications.