

### DESCRIPTION

The HF500-15 is a fixed-frequency, current-mode regulator with built-in slope compensation. It combines a 700V MOSFET and a full-featured controller into one chip for a low-power, offline, flyback, switch-mode power supply.

At medium and heavy loads, the regulator works in a fixed frequency with frequency jittering, which helps to spread energy out in a conducted mode. During a light-load condition, the regulator freezes the peak current and reduces its switching frequency to  $f_{OSC(min)}$  to offer excellent efficiency at light load. At very light loads, the regulator enters burst mode to achieve low standby power consumption.

Full protection features include thermal shutdown, brown-in and brownout, VCC under-voltage lockout (UVLO), overload protection (OLP), short-circuit protection (SCP), input and output over-voltage protection (OVP), and over-temperature protection (OTP).

The HF500-15 features timer-based fault detection and over-power compensation to ensure that the overload is independent of the input voltage.

The HF500-15 is available in a SOIC8-7B package.

	Maximum Output Power <sup>3</sup>			
	230Vac ± 15%		85Vac~265Vac	
	Adapter <sup>1</sup>	Open Frame <sup>2</sup>	Adapter <sup>1</sup>	Open Frame <sup>2</sup>
P <sub>OUT</sub> (W)	12	15	10	12

Notes:

1. Maximum continuous power in a non-ventilated enclosed adapter measured at 50°C ambient temperature.
2. Maximum continuous power in an open frame design at 50°C ambient temperature.
3. The junction temperature can limit the maximum output power.

### FEATURES

- 700V/4.5Ω Integrated MOSFET
- Fixed-Frequency Current-Mode-Control Operation with Built-In Slope Compensation
- Frequency Foldback Down to  $f_{OSC(min)}$  at Light Load
- Burst Mode for Low Standby Power Consumption
- Frequency Jittering for a Reduced EMI Signature
- Over-Power Compensation
- Internal High-Voltage Current Source
- VCC Under-Voltage Lockout (UVLO) with Hysteresis
- Programmable Input B/O and OVP
- Overload Protection (OLP) with a Programmable Delay
- Latch-Off Protection on TIMER
- Thermal Shutdown (Auto-Restart with Hysteresis)
- Short-Circuit Protection (SCP)
- Programmable Soft Start

### APPLICATIONS

- Power Supplies for Home Appliances
- Set-Top Boxes
- Standby and Auxiliary Power
- Adapters

All MPS parts are lead-free, halogen-free, and adhere to the RoHS directive. For MPS green status, please visit the MPS website under Quality Assurance. "MPS" and "The Future of Analog IC Technology" are registered trademarks of Monolithic Power Systems, Inc.

**TYPICAL APPLICATION**

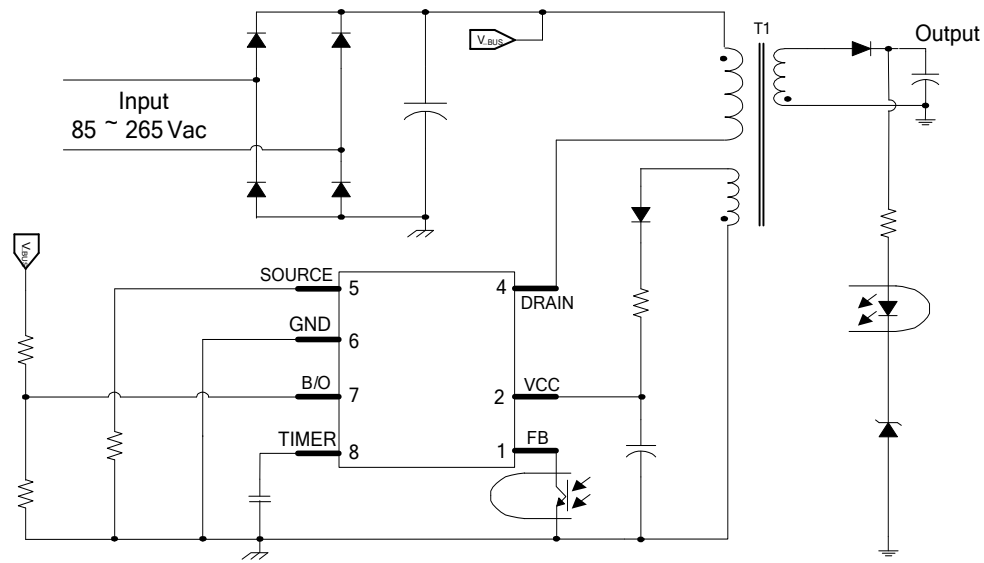

### ORDERING INFORMATION

Part Number*	Package	Top Marking
HF500GS-15	SOIC8-7B	See Below

\* For Tape & Reel, add suffix –Z (e.g. HF500GS-15–Z);

### TOP MARKING

**HF500-15**  
**LLLLLLLL**  
**MPSYWW**

HF500-15: Part number  
 LLLLLLLL: Lot number  
 MPS: MPS prefix  
 Y: Year code  
 WW: Week code

### PACKAGE REFERENCE

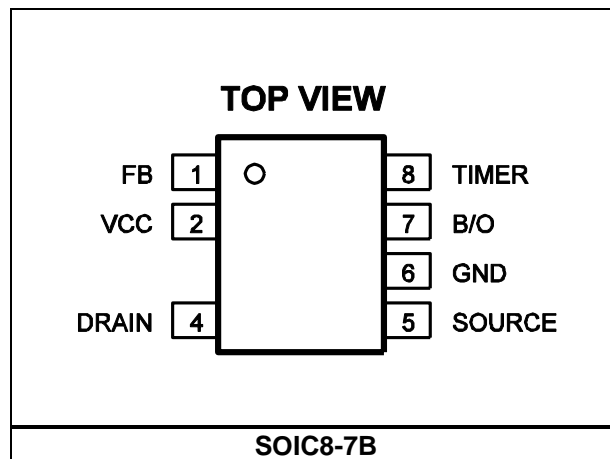

**ABSOLUTE MAXIMUM RATINGS** <sup>(1)</sup>

Drain breakdown voltage .....	-0.3V to 700V
V <sub>CC</sub> to GND .....	-0.3V to 30V
FB, TIMER, SOURCE, B/O to GND..	-0.3V to 7V
Continuous power dissipation (T <sub>A</sub> = +25°C) <sup>(2)</sup>	1.5W
Junction temperature .....	150°C
Lead temperature .....	260°C
Storage temperature .....	-60°C to +150°C
ESD capability human body model (all pins except DRAIN) .....	4.0kV
ESD capability machine model .....	200V

**Recommended Operating Conditions** <sup>(3)</sup>

Operating junction temp (T <sub>J</sub> ) ....	-40°C to +125°C
Operating VCC range .....	12.5V to 24V

<b>Thermal Resistance</b> <sup>(4)</sup>	<b>θ<sub>JA</sub></b>	<b>θ<sub>JC</sub></b>
SOIC8-7B.....	85 .....	40 ... °C/W

**NOTES:**

- 1) Exceeding these ratings may damage the device.
- 2) The maximum allowable power dissipation is a function of the maximum junction temperature T<sub>J</sub> (MAX), the junction-to-ambient thermal resistance θ<sub>JA</sub>, and the ambient temperature T<sub>A</sub>. The maximum allowable continuous power dissipation at any ambient temperature is calculated by P<sub>D</sub> (MAX) = (T<sub>J</sub> (MAX)-T<sub>A</sub>)/θ<sub>JA</sub>. Exceeding the maximum allowable power dissipation produces an excessive die temperature, causing the regulator to go into thermal shutdown. Internal thermal shutdown circuitry protects the device from permanent damage.
- 3) The device is not guaranteed to function outside of its operating conditions.
- 4) Measured on JESD51-7, 4-layer PCB.

**ELECTRICAL CHARACTERISTICS<sup>(5)</sup>**

 For typical value, VCC=16V, T<sub>J</sub> = -40°C to 125°C, unless otherwise noted.

Parameter	Symbol	Conditions	Min	Typ	Max	Unit
<b>Start-Up Current Source (DRAIN)</b>						
Supply current from DRAIN	I <sub>Drain_0</sub>	V <sub>CC</sub> = 0V, V <sub>Drain</sub> = 120V/400V	1.4	3.6	6.2	mA
	I <sub>Drain_11</sub>	V <sub>CC</sub> = 11V, V <sub>Drain</sub> = 120V/400V	1.4	5	7.9	
Leakage current from DRAIN	I <sub>LK</sub>	V <sub>CC</sub> = 10V, V <sub>Drain</sub> = 400V		4.5	10.5	μA
Breakdown voltage	V <sub>BR</sub>	T <sub>J</sub> = 25°C	700			V
<b>Internal MOSFET (DRAIN)</b>						
On-state resistance	R <sub>DS_ON</sub>	V <sub>CC</sub> = 10.5V, I <sub>D</sub> = 0.1A, T <sub>J</sub> = 25°C		4.5	6.5	Ω
<b>Supply Voltage Management (VCC)</b>						
VCC level (increasing) where the internal regulator stops	V <sub>CC_OFF</sub>		11	12	13	V
VCC level (decreasing) where the IC shuts down and the internal regulator turns on	V <sub>CC_UVLO</sub>		6	7	8	V
VCC UVLO hysteresis	V <sub>CC_OFF</sub> – V <sub>CC_UVLO</sub>		4	4.8		V
VCC recharge level when protection occurs	V <sub>CC_PRO</sub>		4.7	5.3	5.9	V
VCC decreasing level where the latch-off phase ends	V <sub>CC_LATCH</sub>			2.5		V
Internal IC consumption	I <sub>CC</sub>	V <sub>FB</sub> = 3V, V <sub>CC</sub> = 12V		0.9	1.2	mA
Internal IC consumption, latch-off phase	I <sub>CC_LATCH</sub>	V <sub>CC</sub> = 12V, T <sub>J</sub> = 25°C		700	900	μA
Voltage on VCC (upper limit) where the regulator latches off (OVP)	V <sub>OVP</sub>		25	27	29	V
Blanking duration on the OVP comparator	T <sub>OVP</sub>			60		ms
<b>Oscillator</b>						
Oscillator frequency	f <sub>OSC</sub>	V <sub>FB</sub> > 1.85V, T <sub>J</sub> = 25°C	62	65	68	kHz
Frequency jittering amplitude in percentage of f <sub>OSC</sub>	A <sub>jitter</sub>	V <sub>FB</sub> > 1.85V, T <sub>J</sub> = 25°C	±5	±6.5	±8	%
Frequency jittering entry level	V <sub>FB_JITTER</sub>				1.95	V
Frequency jittering modulation period	T <sub>jitter</sub>	C <sub>TIMER</sub> = 47nF		3.7		ms

**ELECTRICAL CHARACTERISTICS<sup>(5)</sup> (continued)**

 For typical value, VCC=16V, T<sub>J</sub> = -40°C to 125°C, unless otherwise noted.

Parameter	Symbol	Conditions	Min	Typ	Max	Unit
<b>Protections (B/O)</b>						
Brown-in threshold voltage on B/O	V <sub>B/O_IN</sub>	V <sub>B/O</sub> increasing	0.95	1	1.05	V
Brownout threshold voltage on B/O	V <sub>B/O_OUT</sub>	V <sub>B/O</sub> decreasing	0.85	0.9	0.95	V
Brown-in/out hysteresis	ΔV <sub>B/O</sub>		0.065	0.1	0.14	V
Timer duration for line cycle dropout	T <sub>B/O</sub>	C <sub>TIMER</sub> = 47nF	34	55		ms
Input OVP threshold on B/O	OVP <sub>B/O</sub>		4.2	4.5	4.8	V
Input OVP delay time	T <sub>OVPB/O</sub>			90		μs
Voltage on B/O to disable B/O and input OVP function	V <sub>DIS</sub>		5.4	6	6.6	V
Clamp voltage on B/O	V <sub>B/O_Cla</sub>		7			V
Input impedance	R <sub>B/O</sub>		1.2			MΩ
<b>Current Sense (SOURCE)</b>						
Current limit point	V <sub>ILIM</sub>		0.93	1	1.07	V
Short-circuit protection point	V <sub>SCP</sub>		1.3	1.5	1.7	V
Current limitation during frequency foldback	V <sub>FOLD</sub>	V <sub>FB</sub> = 1.85V	0.63	0.68	0.73	V
Current limitation when entering burst	V <sub>IBURL</sub>	V <sub>FB</sub> = 0.7V		0.1		V
Current limitation when exiting burst	V <sub>IBURH</sub>	V <sub>FB</sub> = 0.8V		0.13		V
Leading-edge blanking for V <sub>ILIM</sub>	T <sub>LEB1</sub>			350		ns
Leading-edge blanking for V <sub>SCP</sub>	T <sub>LEB2</sub>			270		ns
Slope of the compensation ramp	S <sub>RAMP</sub>		18	25	31	mV/μs
<b>Feedback (FB)</b>						
Internal pull-up resistor	R <sub>FB</sub>	T <sub>J</sub> = 25°C	12	13.5	15	kΩ
Internal pull-up voltage	V <sub>DD</sub>			4.3		V
V <sub>FB</sub> to internal current-set point division ratio	K <sub>FB1</sub>	V <sub>FB</sub> = 2V	2.5	2.8	3.1	
V <sub>FB</sub> to current-set point division ratio	K <sub>FB2</sub>	V <sub>FB</sub> = 3V	2.8	3.1	3.4	
FB level (decreasing) where the regulator enters burst mode	V <sub>BURL</sub>		0.63	0.7	0.77	V
FB level (increasing) where the regulator exits burst mode	V <sub>BURH</sub>		0.72	0.8	0.88	V

**ELECTRICAL CHARACTERISTICS<sup>(5)</sup> (continued)**

 For typical value, VCC=16V, T<sub>J</sub> = -40°C to 125°C, unless otherwise noted.

Parameter	Symbol	Conditions	Min	Typ	Max	Unit
<b>Over-Load Protection (FB)</b>						
FB level where the regulator enters OLP after a dedicated time	V <sub>OLP</sub>			3.7		V
Time duration before OLP when FB reaches the protection point	T <sub>OLP</sub>	C <sub>TIMER</sub> = 47nF	32			ms
<b>Over-Power Compensation (B/O)</b>						
Compensation voltage	V <sub>OPC</sub>	V <sub>B/O</sub> = 1.1V, V <sub>FB</sub> =2.5V, T <sub>J</sub> = 25°C		0		mV
		V <sub>B/O</sub> = 1.3V, V <sub>FB</sub> =2.5V, T <sub>J</sub> = 25°C		19		
		V <sub>B/O</sub> = 2.9V, V <sub>FB</sub> =2.5V, T <sub>J</sub> = 25°C	153	200	247	
		V <sub>B/O</sub> = 3.5V, V <sub>FB</sub> =2.5V, T <sub>J</sub> = 25°C	205	270	335	
		V <sub>B/O</sub> > V <sub>DIS</sub> , T <sub>J</sub> = 25°C		0		
FB voltage (lower limit) when compensation is removed	V <sub>OPC(OFF)</sub>		0.55			V
FB voltage (upper limit) when compensation is fully applied	V <sub>OPC(ON)</sub>				2.5	V
<b>Frequency Foldback</b>						
FB voltage (lower threshold) when frequency foldback starts	V <sub>FB(FOLD)</sub>			1.8		V
Minimum switching frequency	f <sub>OSC(min)</sub>	T <sub>J</sub> = 25°C	20.5	25	30	kHz
FB voltage (lower threshold) when frequency foldback ends	V <sub>FB(FOLDE)</sub>			1		V
<b>Latch-Off Input (Integration in TIMER)</b>						
Lower threshold when the regulator is latched	V <sub>TIMER(LATCH)</sub>		0.7	1	1.2	V
Blanking duration on latch detection	T <sub>LATCH</sub>			42		µs
<b>Thermal Shutdown</b>						
Thermal shutdown threshold	T <sub>TSD</sub>			150		°C
Thermal shutdown hysteresis	T <sub>TSD(HYS)</sub>			25		°C

## PIN FUNCTIONS

Pin #	Name	Description
1	FB	<b>Feedback.</b> A pull-down optocoupler controls the output regulation.
2	VCC	<b>Power supply of the IC.</b> VCC enters OVP if the voltage on VCC rises above $V_{OVP}$ .
4	DRAIN	<b>Drain of the internal MOSFET.</b> Input for the start-up, high-voltage current source.
5	SOURCE	<b>Source of the internal MOSFET.</b> Input of the primary current sense signal.
6	GND	<b>Ground.</b>
7	B/O	<b>Brown-in/out, input OVP, and over-power compensation detection.</b> Brown-in/out, input OVP and over-power compensation is achieved by detecting the voltage on B/O. All of the functions are disabled when B/O is pulled higher than $V_{DIS}$ .
8	TIMER	<b>TIMER combines the soft start, the frequency jittering, and the timer functions for OLP and brownout protection.</b> The IC is latched by pulling TIMER down. It allows for external OVP and OTP detection.



## TYPICAL CHARACTERISTICS

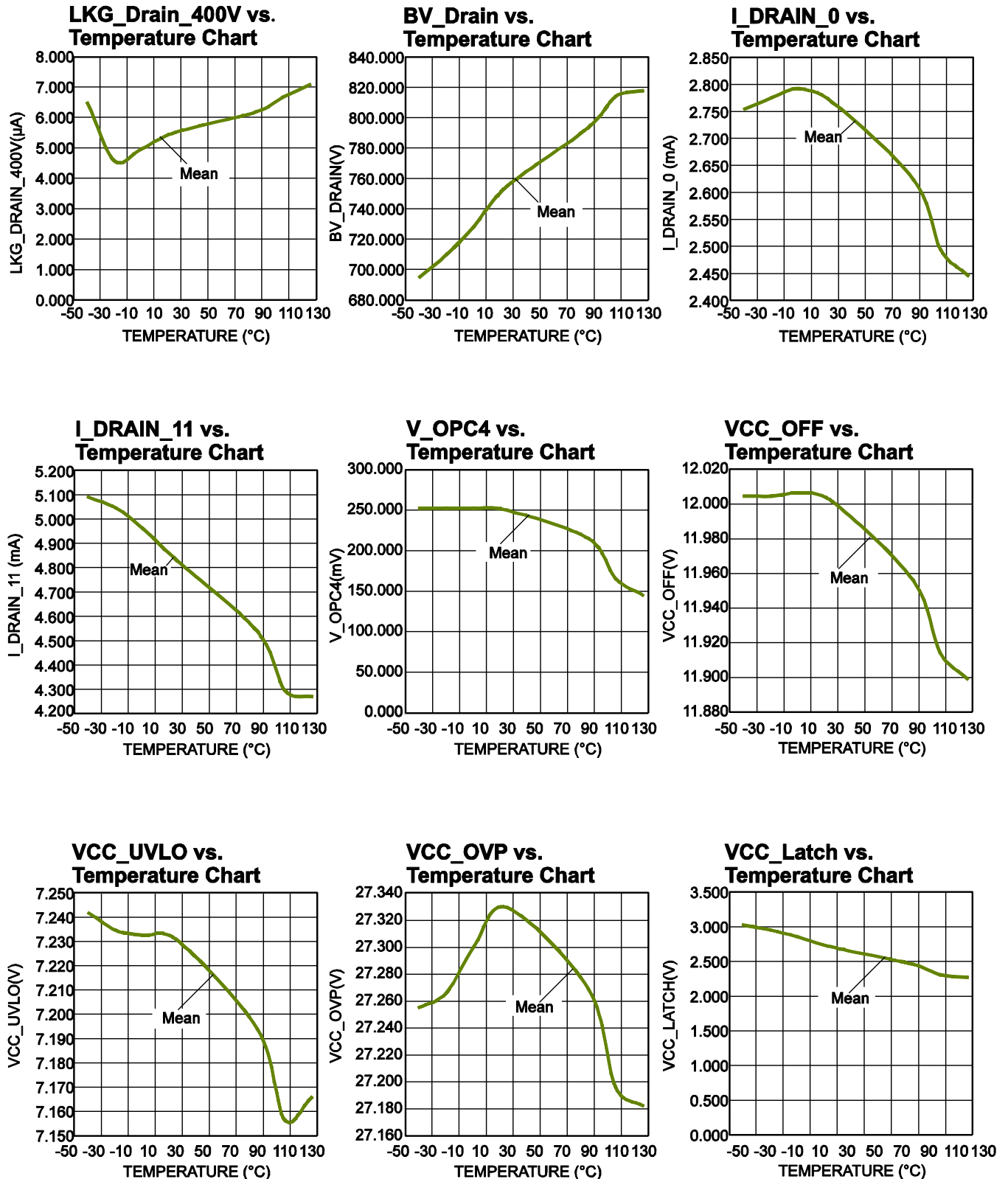

## TYPICAL CHARACTERISTICS (continued)

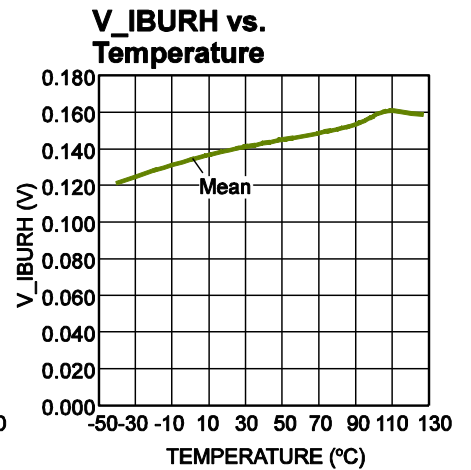
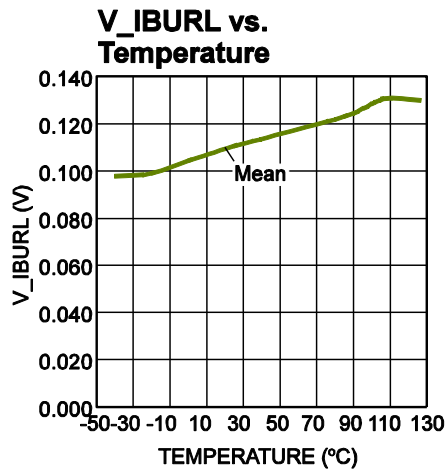
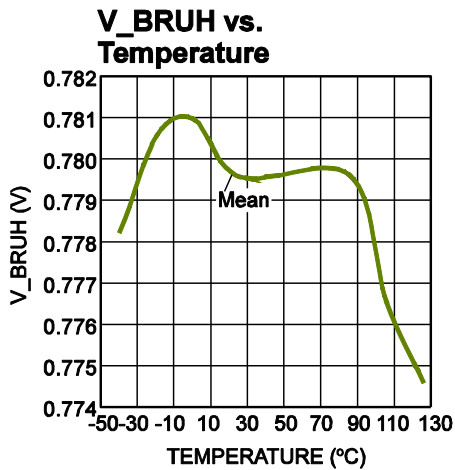
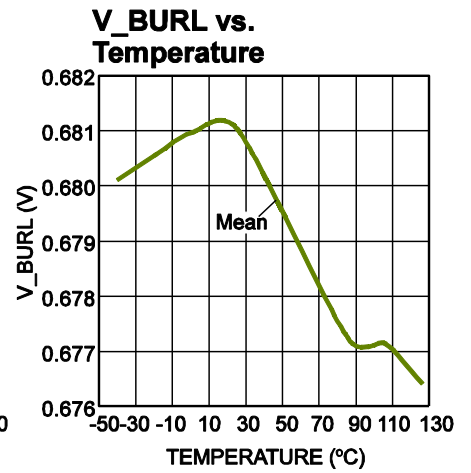
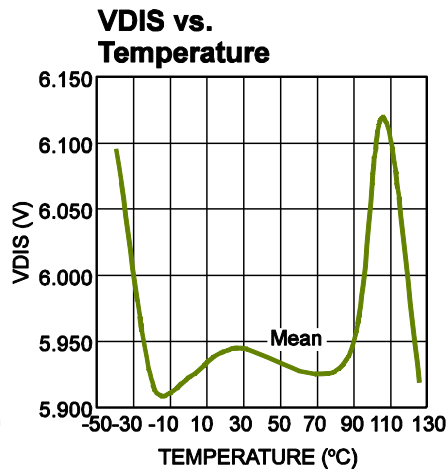
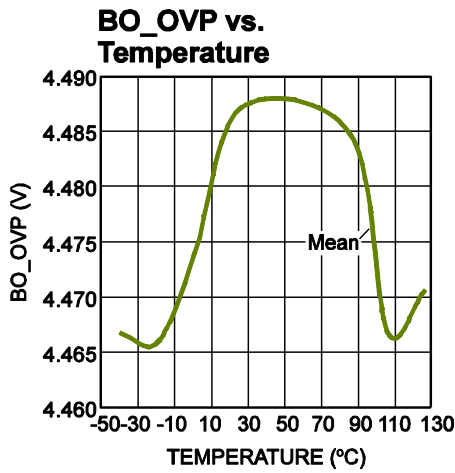
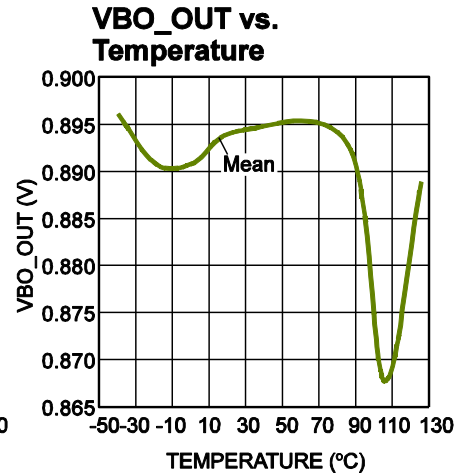
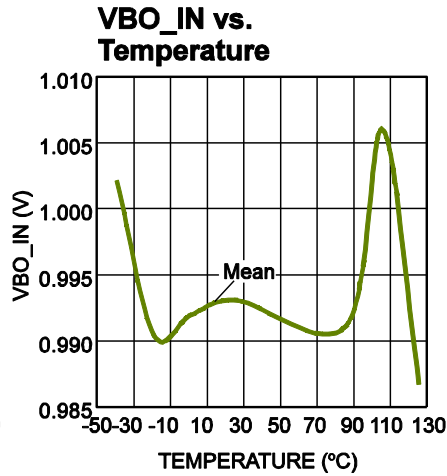
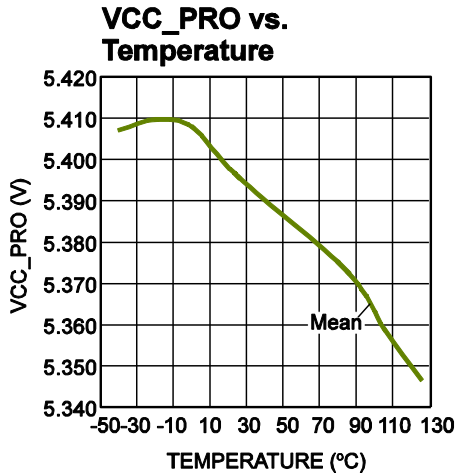

## TYPICAL CHARACTERISTICS (continued)

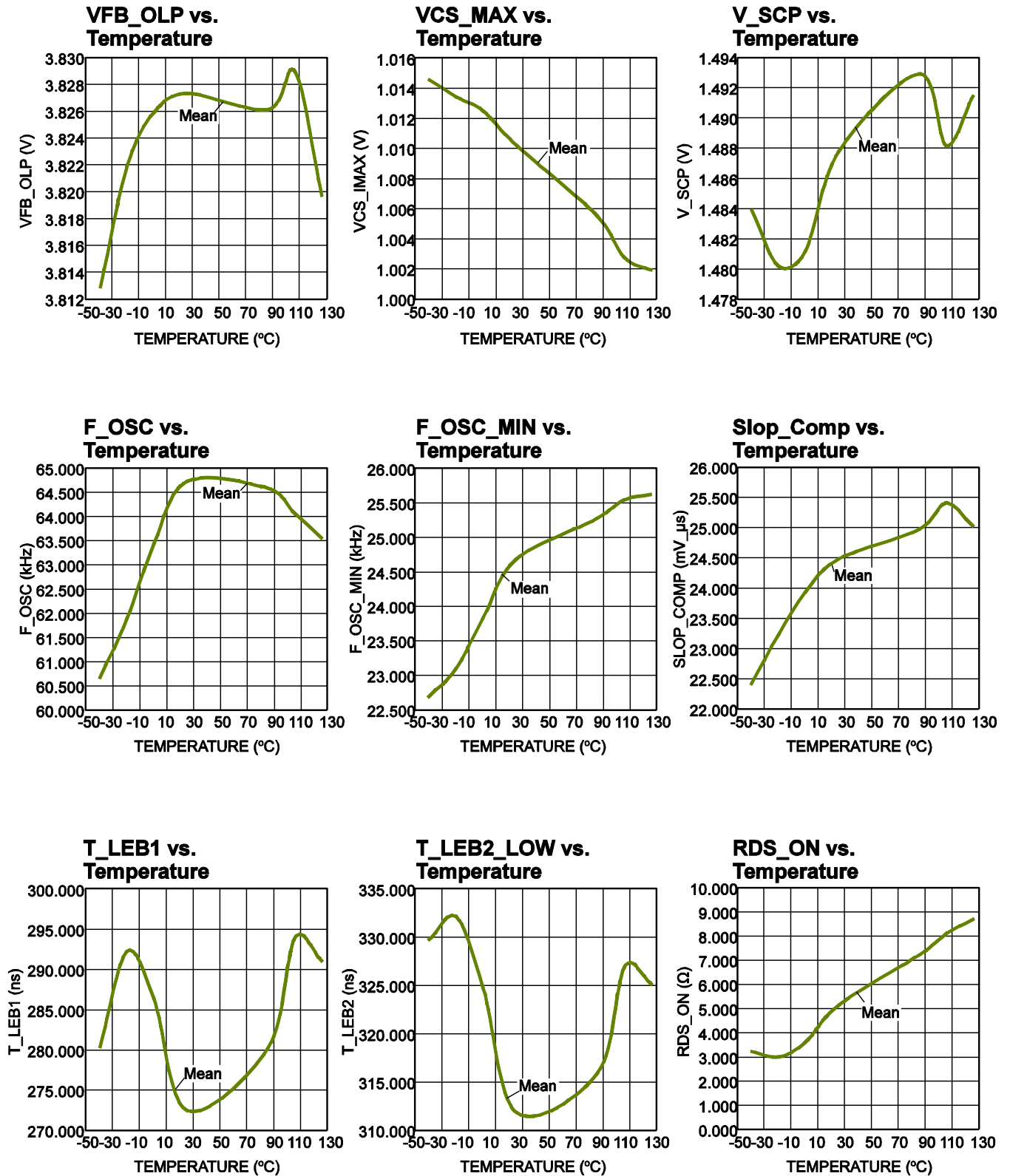

**TYPICAL PERFORMANCE CHARACTERISTIC**
 $V_{IN} = 230V_{AC}$ ,  $V_{OUT} = 12V$ ,  $I_{OUT} = 1A$ , unless otherwise noted.

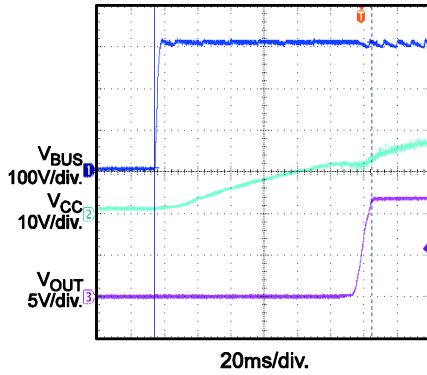
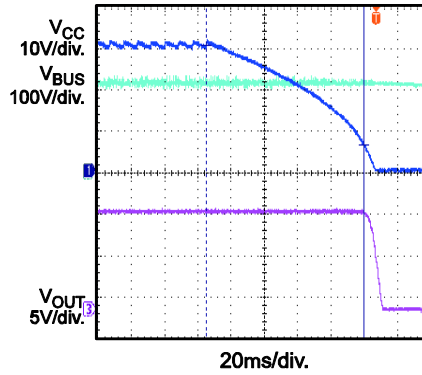
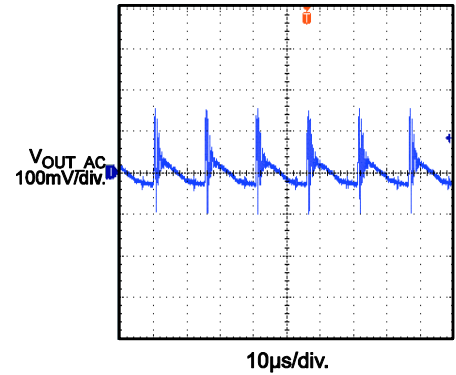
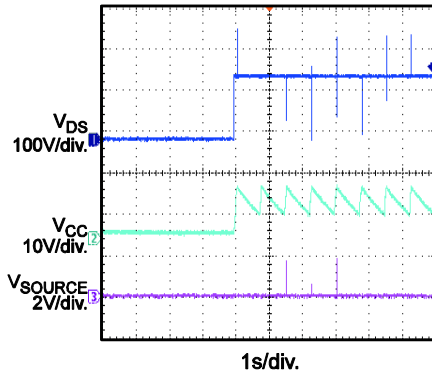
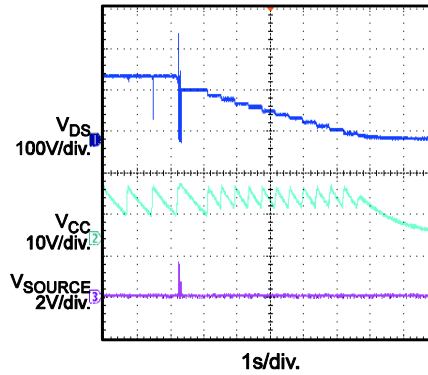
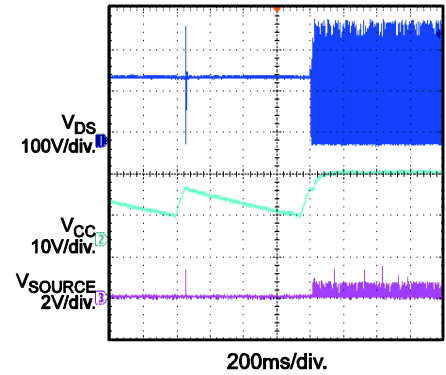
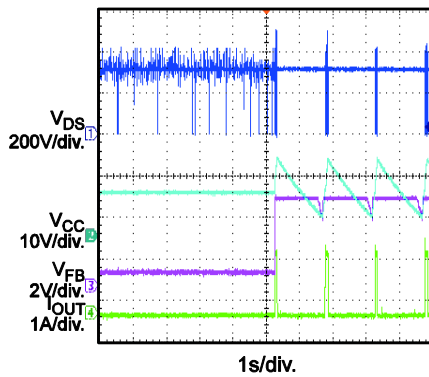
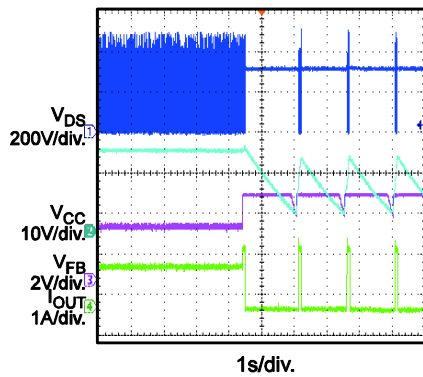
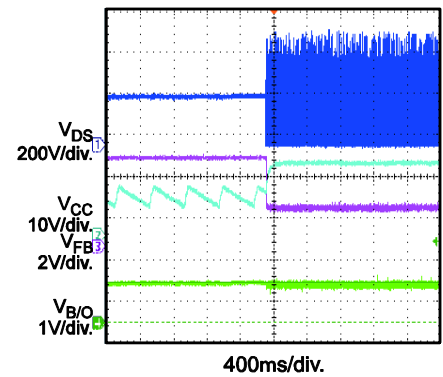
**Input Power On**

**Input Power Off**

**Output Ripple**

**SCP Power On**
 $V_{IN} = 115V_{AC}$ 

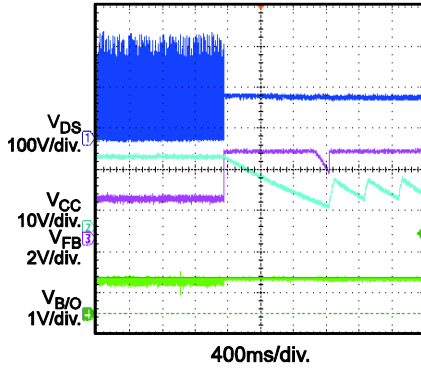
**SCP Power Off**
 $V_{IN} = 115V_{AC}$ 

**SCP Release**
 $V_{IN} = 115V_{AC}$ 

**OLP Entry, No Load**

**OLP Entry, Full Load**

**Brown In, Full Load**

**TYPICAL PERFORMANCE CHARACTERISTIC (continued)**

$V_{IN} = 230V_{AC}$ ,  $V_{OUT} = 12V$ ,  $I_{OUT} = 1A$ , unless otherwise noted.

**Brown Out, Full Load**



**OVP Entry, No Load**

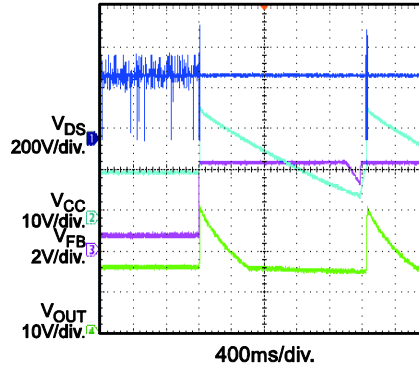

**OVP Recovery, No Load**

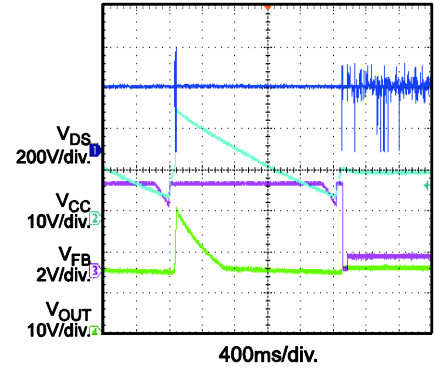

**OVP Power On, No Load**

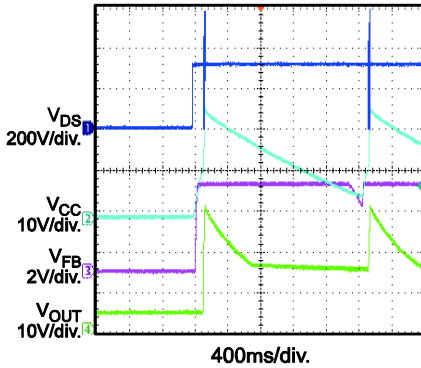

**OTP Entry**

$V_{IN} = 85Vac$

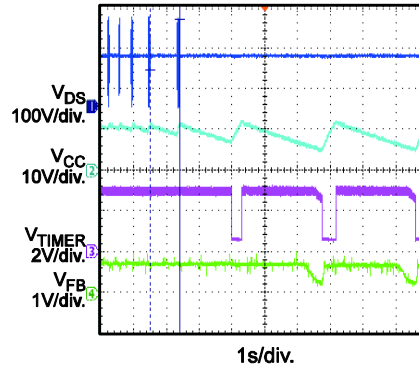

**OTP Recovery**

$V_{IN} = 85Vac$

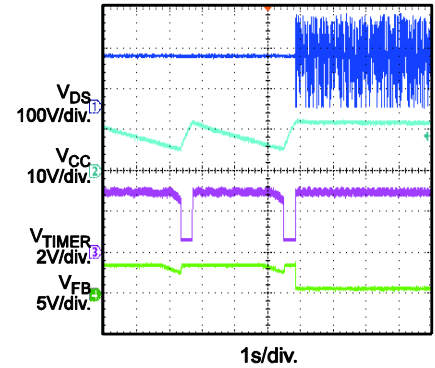

**Stress**

$V_{IN} = 265Vac$

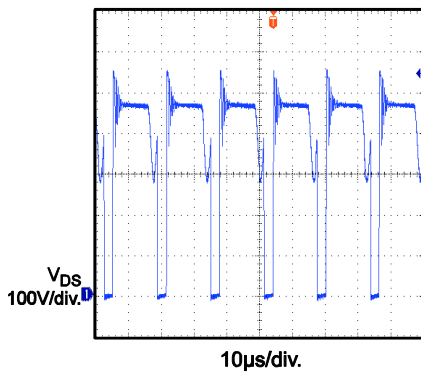

**Conducted EMI, L**

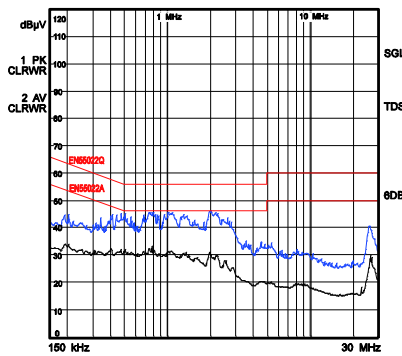

**Conducted EMI, N**

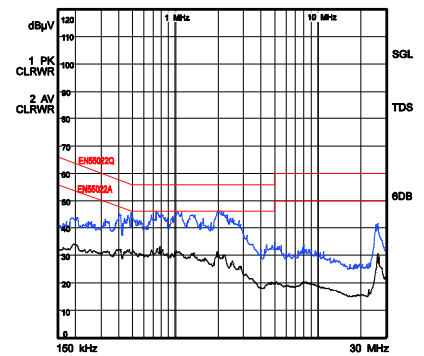

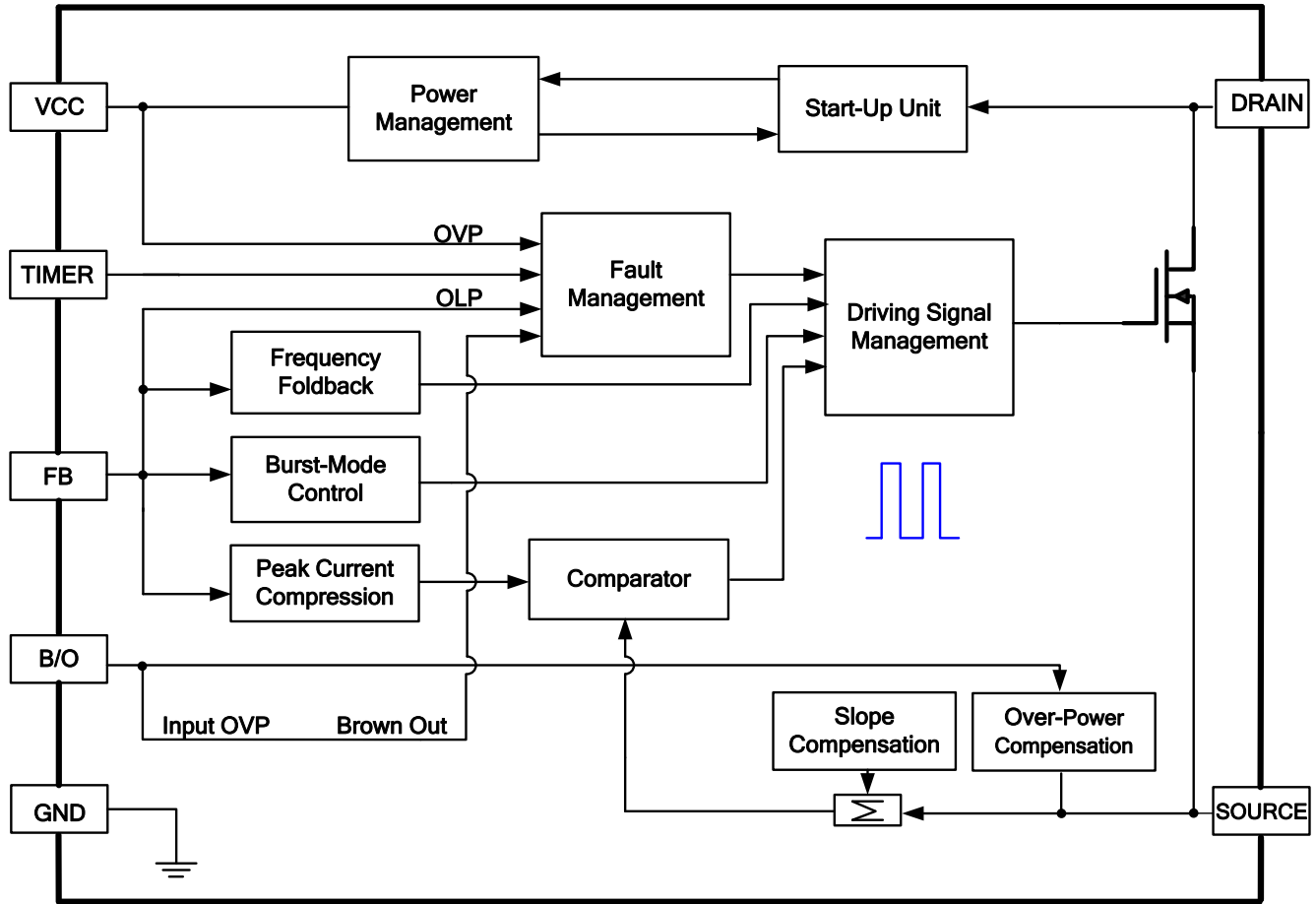

**Figure 1: Functional Block Diagram**

## OPERATION

The HF500-15 is a fixed-frequency, current-mode regulator with built-in slope compensation that incorporates all of the necessary features to build a reliable switch-mode power supply. In light-load conditions, the regulator freezes the peak current and reduces its switching frequency to 25kHz to minimize switching loss. When the output power falls below a given level, the regulator enters burst mode. The HF500-15 uses frequency jittering to improve EMI performance.

### Fixed Frequency with Jittering

Frequency jittering reduces EMI by spreading out the energy. Figure 2 shows the frequency jitter circuit.

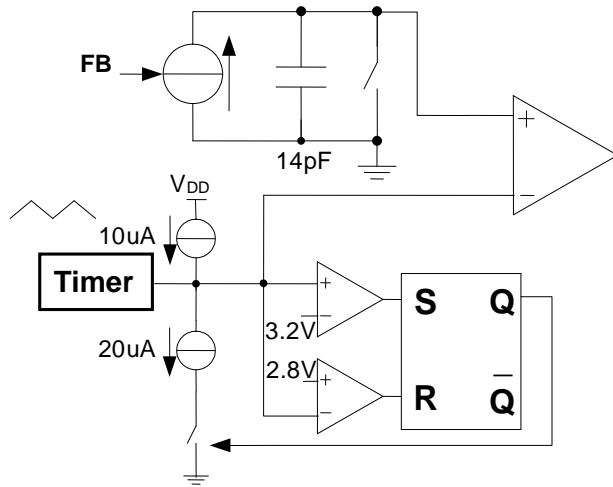

Figure 2: Frequency Jitter Circuit

An internal capacitor is charged with a controlled current source, which is fixed when  $FB > 2V$ , and its voltage is compared with the TIMER voltage. The TIMER voltage is a triangular wave between 2.8V and 3.2V with a charging/discharging current (see Figure 3). The switching frequency can be calculated using Equation (1):

$$f_s = \frac{1 \cdot 10^6}{5.28 \cdot V_{TIMER} / V + 0.2} \text{ Hz} \quad (1)$$

$T_{jitter}$  can be calculated using Equation (2):

$$T_{jitter} = 8 \cdot C_{TIMER} / nF \cdot 10^{-5} \text{ s} \quad (2)$$

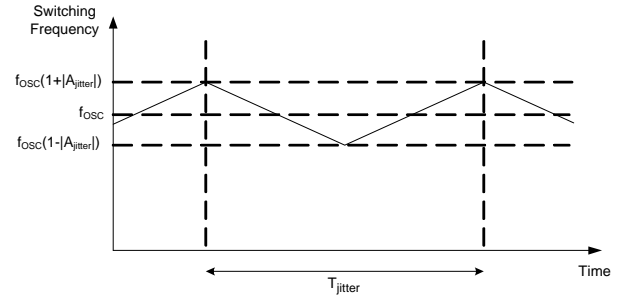

Figure 3: Frequency Jittering

### Frequency Foldback

To achieve high efficiency during all load conditions, the HF500-15 implements frequency foldback during light-load conditions.

When the load decreases to a given level, the regulator freezes the  $V_{FOLD}$  peak current and reduces the charging current, dropping its switching frequency down to 25kHz and reducing switching loss. If the load continues to decrease, the peak current decreases with a 25kHz fixed frequency to avoid audible noise. Figure 4 shows the frequency and peak current vs. FB.

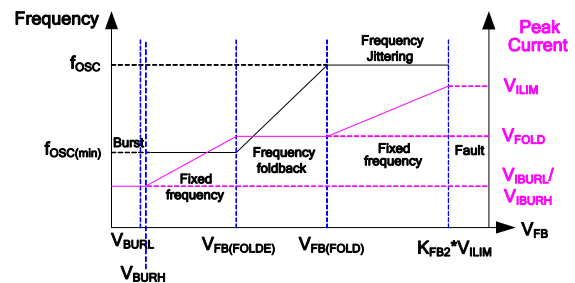

Figure 4: Frequency and Peak Current vs. FB

### Current-Mode Operation with Slope Compensation

The primary peak current is controlled by the FB voltage. When the peak current reaches the level determined by FB, the MOSFET turns off. Also, the regulator operates in continuous conduction mode (CCM) with a wide input voltage range. Its internal synchronous slope compensation ( $S_{RAMP}$ ) helps avoid subharmonic oscillation when the duty cycle is larger than 50% at CCM.

### High-Voltage Start-Up Current Source

Initially, the IC is self-supplied by the internal high-voltage current source, which is drawn from DRAIN. The IC turns off the current source

once the voltage on VCC reaches VCC<sub>OFF</sub>. If the voltage on VCC falls below VCC<sub>UVLO</sub>, the switching pulse stops, and the current source turns on again. The auxiliary winding takes over the power supply for the IC when the output voltage rises normally to the set voltage. The lower threshold of VCC UVLO is pulled down from VCC<sub>UVLO</sub> to VCC<sub>PRO</sub> when a fault condition occurs, such as OLP, SCP, brownout, OVP, OTP, etc (see Figure 5).

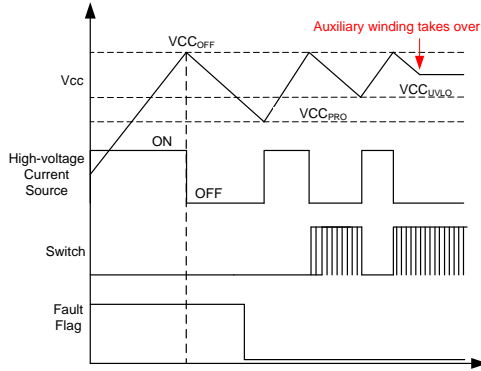

Figure 5: VCC Power Supply Process

**Soft Start (SS)**

To reduce the stress on the power components and smoothly establish the output voltage, the TIMER voltage increases from 1V to 1.75V with a 1/4 charge current during normal operation at every start-up. The TIMER voltage increases the peak current from 0.25V to 1V gradually. The switching frequency also increases gradually. Figure 6 shows the typical waveform of a soft start.

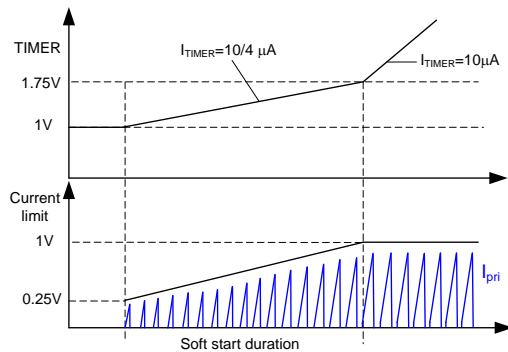

Figure 6: Soft Start

The start-up duration can be adjusted by the capacitor connected to TIMER. The TIMER capacitor determines the start-up duration, shown in Equation (3):

$$T_{\text{Soft-start}} = 0.3 \cdot C_{\text{TIMER}} / nF \cdot 10^{-3} s \quad (3)$$

**Burst Operation**

The HF500-15 uses burst-mode operation to minimize the power dissipation in no-load or light-load conditions. As the load decreases, the FB voltage decreases. The IC stops the switching cycle when the FB voltage drops below the lower threshold (V<sub>BURL</sub>); the FB increases again once the output voltage drops. Switching resumes once the FB voltage exceeds the threshold (V<sub>BURH</sub>). The FB voltage then falls and rises repeatedly. Burst-mode operation alternately enables and disables the switching cycle of the MOSFET, thereby reducing switching loss at no-load or light-load conditions.

**Over-Power Compensation**

An offset voltage proportional to the B/O voltage is added to the sensing voltage. The B/O voltage is proportional to the input voltage. Figure 7 shows the compensation in relation to the voltage on FB and B/O. The V<sub>OPC</sub> can be calculated using Equation (4):

$$V_{\text{OPC}} = 0.094 \cdot (V_{\text{B/O}} - 1.1V) \quad (4)$$

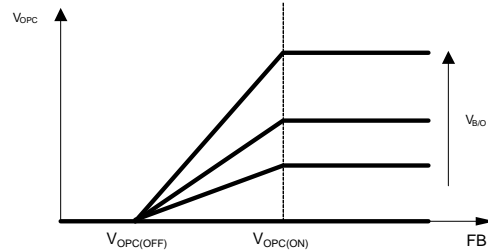

Figure 7: Compensation Current vs. FB and B/O Voltage

**Timer Based Overload Protection (OLP)**

If the switching frequency is fixed in a flyback converter, the maximum output power is limited by the peak current. When the output consumes more than the limited power, the output voltage drops below the set value. The current flowing through the primary and secondary optocoupler is then reduced, and the FB voltage is pulled high (see Figure 8).

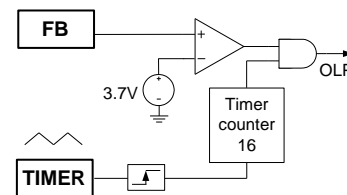
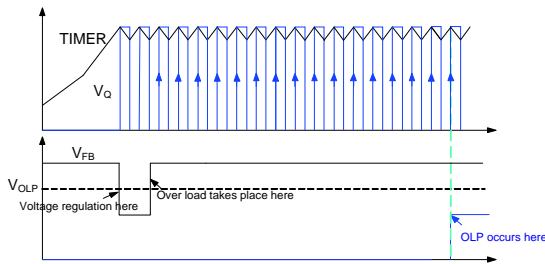

Figure 8: Overload Protection Block



FB rising higher than  $V_{OLP}$  is considered an error flag and causes the timer to start counting the rising edge of  $V_Q$ . When the error flag is removed, the timer resets. When the timer reaches completion after it has counted to 16, it enters OLP. This timer duration does not trigger the OLP function when the power supply is starting up or during a load transition phase. Figure 9 shows the OLP function.



**Figure 9: Overload Protection Function**

### Input Brownout and Input OVP

The input brownout and input OVP can be realized by B/O. If the B/O voltage is higher than  $V_{B/O\_IN}$  during the input voltage rising period, the IC begins operating. If the B/O voltage is lower than  $V_{B/O\_OUT}$  for  $T_{B/O}$  ( $C_{TIMER} = 47nF$ ), the IC stops operation. If the voltage on B/O is higher than  $OVP_{B/O}$  for  $T_{OVPB/O}$ , the IC stops operating, achieving the input OVP. If the voltage on B/O is higher than  $V_{DIS}$ , it disables the input brownout and input OVP functions. To simplify the external circuit, connect B/O to VCC through a resistor if the input brownout, over-power compensation, and the input OVP functions are not desired.

### Short-Circuit Protection (SCP)

The HF500-15 features a short-circuit protection that senses the SOURCE voltage and stops switching if  $V_{SOURCE}$  reaches  $V_{SCP}$  after a reduced leading-edge blanking time ( $T_{LEB2}$ ). Once the fault disappears, the power supply resumes operation.

### Thermal Shutdown

The HF500-15 uses thermal shutdown to turn off the switching cycle when the inner temperature exceeds  $T_{OTP}$ . As soon as the inner temperature drops below  $T_{OTP(HYS)}$ , the power supply resumes operation. During thermal shutdown, the VCC UVLO lower threshold is pulled down from  $VCC_{UVLO}$  to  $VCC_{PRO}$ .

### VCC Over-Voltage Protection (OVP)

The HF500-15 enters a latched fault condition if the VCC voltage rises above  $V_{OVP}$  for  $T_{OVP}$ . The regulator remains fully latched until VCC drops below  $VCC_{LATCH}$  (e.g. the user unplugs the power supply from the main input and plugs it back in). Usually, this situation occurs when the optocoupler fails, resulting in the loss of the output voltage regulation.

### TIMER Protection

The HF500-15 is latched off by pulling TIMER below  $V_{TIMER(LATCH)}$  for  $T_{LATCH}$ . This allows TIMER to be used for external OVP and OTP functions by adding an external compact circuit.

### Leading-Edge Blanking (LEB)

An internal leading-edge blanking (LEB) unit containing two LEB times is placed between SOURCE and the current comparator input to avoid premature switching pulse termination due to parasitic capacitances. During the blanking time, the current comparator is disabled and cannot turn off the external MOSFET. Figure 10 shows the LEB waveform.

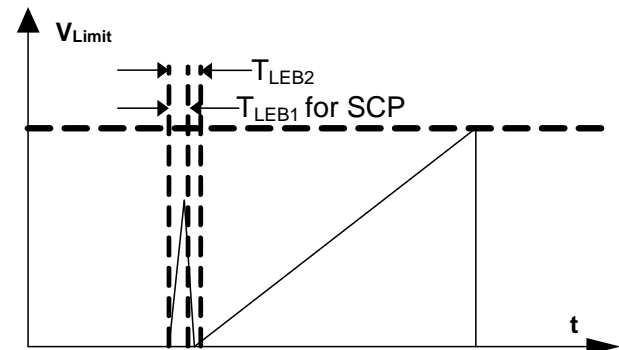

**Figure 10: Leading-Edge Blanking**

## APPLICATION INFORMATION

### VCC Capacitor Selection

When the input voltage is applied, the VCC capacitor is charged up by the IC internal high-voltage current source. Set the output voltage before the VCC voltage drops below  $V_{CC_{UVLO}}$ . Otherwise, VCC charges and discharges repeatedly, and the output voltage cannot be set normally. For most applications, choose a VCC capacitor value between 10 $\mu$ F and 47 $\mu$ F. The value for the VCC capacitor can be estimated with Equation (5):

$$C_{VCC} > \frac{I_{CC} \cdot T_{rise}}{V_{CC_{OFF}} - V_{CC_{UVLO}}} \quad (5)$$

Where  $I_{CC}$  is the internal consumption and  $T_{rise}$  is the output voltage rise period.

### Primary-Side Inductor Design ( $L_m$ )

The HF500-15 uses an internal slope compensation to support CCM when the duty cycle exceeds 50%. Set a ratio ( $K_P$ ) of the primary inductor's ripple current amplitude vs. the peak current value to  $0 < K_P \leq 1$ , where  $K_P = 1$  for DCM. Figure 11 shows the relevant waveforms. A larger inductor leads to a smaller  $K_P$ , which reduces the RMS current, but increases transformer size. An optimal  $K_P$  value is between 0.7 and 0.8 for the universal input range and CrCM or DCM for the 230V<sub>AC</sub> input range.

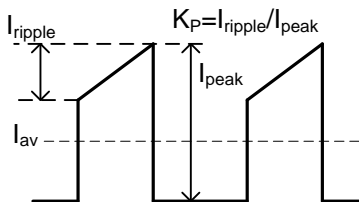

**Figure 11: Typical Primary Current Waveform**

The input power ( $P_{in}$ ) at the minimum input can be estimated with Equation (6):

$$P_{in} = \frac{V_O \cdot I_O}{\eta} \quad (6)$$

Where  $V_O$  is the output voltage,  $I_O$  is the rated output current, and  $\eta$  is the estimated efficiency, typically between 0.75 and 0.85 depending on the input range and output voltage.

For CCM at a minimum input, calculate the converter duty cycle with Equation (7):

$$D = \frac{(V_O + V_F) \cdot N}{(V_O + V_F) \cdot N + V_{in(min)}} \quad (7)$$

Where  $V_F$  is the secondary diode's forward voltage,  $N$  is the transformer turn ratio, and  $V_{IN(MIN)}$  is the minimum voltage on the bulk capacitor.

The MOSFET turn-on time is calculated with Equation (8):

$$T_{on} = D \cdot T_s \quad (8)$$

Where  $T_s$  is the frequency jitter's dominant switching period, and  $\frac{1}{T_s} = f_s = 65\text{kHz}$ .

The average value of the primary current can be calculated with Equation (9):

$$I_{av} = \frac{P_{in}}{V_{in(min)}} \quad (9)$$

The peak value of the primary current can be calculated with Equation (10):

$$I_{peak} = \frac{I_{av}}{\left(1 - \frac{K_P}{2}\right) \cdot D} \quad (10)$$

The ripple value of the primary current can be calculated with Equation (11):

$$I_{ripple} = K_P \cdot I_{peak} \quad (11)$$

The valley value of the primary current can be calculated with Equation (12):

$$I_{valley} = (1 - K_P) \cdot I_{peak} \quad (12)$$

$L_m$  can be calculated with Equation (13):

$$L_m = \frac{V_{in(min)} \cdot T_{on}}{I_{ripple}} \quad (13)$$

### Current-Sense Resistor

Figure 12 shows the peak current comparator logic and the subsequent waveform. When the sum of the sensing resistor voltage and the slope compensator reaches  $V_{peak}$ , the comparator goes high to reset the RS flip-flop, and the MOSFET is turned off.

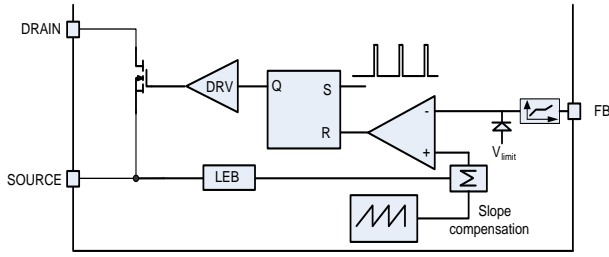

a) Peak Current Comparator Circuit

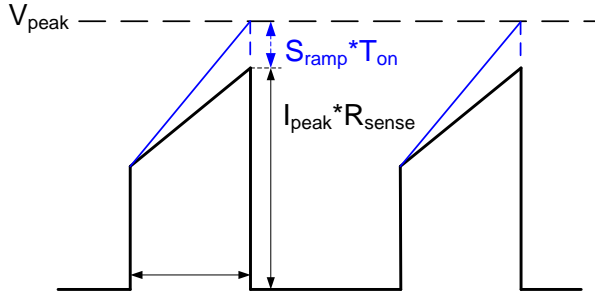

b) Typical Waveform

Figure 12: Peak Current Comparator

The maximum current limit is  $V_{ILIM}$ . The ramp of the slope compensator is  $S_{ramp}$ . Given a certain margin, use  $0.95 \times V_{ILIM}$  as  $V_{peak}$  at full load. Calculate the voltage on the sensing resistor with Equation (14):

$$V_{sense} = 95\% \cdot V_{ILIM} - S_{ramp} \cdot T_{on} \quad (14)$$

The value of the sense resistor is then calculated with Equation (15):

$$R_{sense} = \frac{V_{sense}}{I_{peak}} \quad (15)$$

Select a current-sense resistor with an appropriate power rating. Estimate the sense resistor power loss with Equation (16):

$$P = \left[ \left( \frac{I_{peak} + I_{valley}}{2} \right)^2 + \frac{1}{12} (I_{peak} - I_{valley})^2 \right] \cdot D \cdot R_{sense} \quad (16)$$

### Jitter Period

Frequency jitter is used as an effective method for reducing EMI by dissipating energy. The  $n^{th}$ -order harmonic noise bandwidth is  $B_{Tn} = n \cdot (2 \cdot \Delta f + f_{jitter})$ , where  $\Delta f$  is the frequency jitter amplitude. If  $B_{Tn}$  exceeds the resolution bandwidth (RBW) of the spectrum analyzer (200Hz for noise frequency less than 150kHz, 9kHz for noise frequency between 150kHz and

30MHz), the spectrum analyzer receives less noise energy.

The capacitor on TIMER determines the period of the frequency jitter. A  $10\mu A$  current source charges the capacitor when the TIMER voltage reaches 3.2V, and another  $10\mu A$  current source discharges the capacitor to 2.8V. This charging and discharging cycle repeats.

Equation (2) describes the jitter period in theory. A smaller  $f_{jitter}$  is more effective for EMI reduction. However, the measurement bandwidth requires  $f_{jitter}$  to be large compared to the spectrum analyzer RBW for effective EMI reduction. Also,  $f_{jitter}$  should be less than the control loop gain crossover frequency to avoid disturbing the output voltage regulation.

The TIMER capacitor must be selected carefully. A capacitor that is too large may cause the start-up to fail at full load because of the long, soft start-up duration, shown in Equation (3). However, a TIMER capacitor that is too small causes the timer period to decrease, which overloads the timer count capability and may cause logic problems. For most applications, a  $f_{jitter}$  between 200Hz and 400Hz is recommended.

### Ramp Compensation

In peak current control, subharmonic oscillation occurs when  $D > 0.5$  in CCM. The HF500-15 solves this problem with internal ramp compensation. Calculate  $\alpha$  with Equation (17). For stable operation,  $\alpha$  must be less than 1:

$$\alpha = \frac{\frac{D_{max} \cdot V_{in(min)}}{(1-D_{max}) \cdot L_m} \cdot R_{sense} - m_a}{\frac{V_{in(min)}}{L_m} \cdot R_{sense} + m_a} \quad (17)$$

Where  $m_a = 20mV/\mu s$  is the minimum internal slope value of the compensation ramp, and  $\frac{V_{in(min)}}{L_m} \cdot R_{sense}$  and  $\frac{D_{max} \cdot V_{in(min)}}{(1-D_{max}) \cdot L_m} \cdot R_{sense}$  are the slew rates of the primary-side and equivalent secondary-side voltages sensed by the current-sensing resistor respectively.

### PCB Layout Guidelines

Efficient PCB layout is critical for stable operation, good EMI performance, and good thermal performance. For best results refer to Figure 13 and follow the guidelines below:

1. Minimize the power stage loop area for better EMI performance. This includes the input loop (C4 - T1 - U1 - R2/R4 - C4), the auxiliary winding loop (T1 - D7 - R12 - C7 - T1), the output loop (T1 - D8 - C10 - T1), and the RCD snubber loop (T1 - R9 - D6 - R10/C6 - T1).
2. Keep the input loop GND and the control circuit GND separate and only connect them at C4. Otherwise, the IC operation may be influenced by noise.
3. Place the control circuit capacitors (such as those for FB, B/O, and VCC) close to the IC to decouple noise effectively.
4. Place a larger source area around the IC to improve thermal performance, if needed.

### Design Example

Table 1 below is a design example of the HF500-15 for power adapter applications.

**Table 1: Design Specification**

$V_{IN}$	85 to 265VAC
$V_{OUT}$	12V
$I_{OUT}$	1A

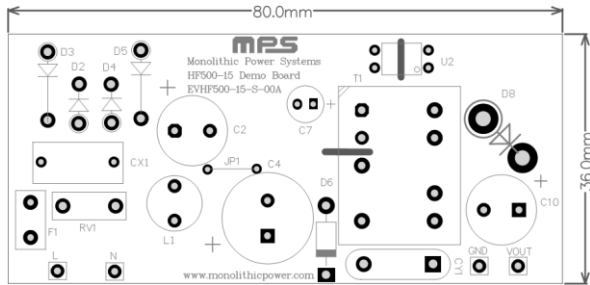

**a) Top**

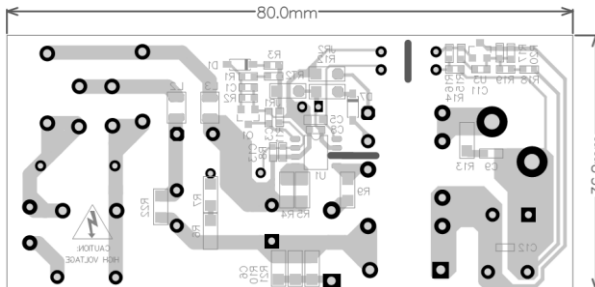

**b) Bottom**

**Figure 13: Recommended PCB Layout**

TYPICAL APPLICATION CIRCUIT

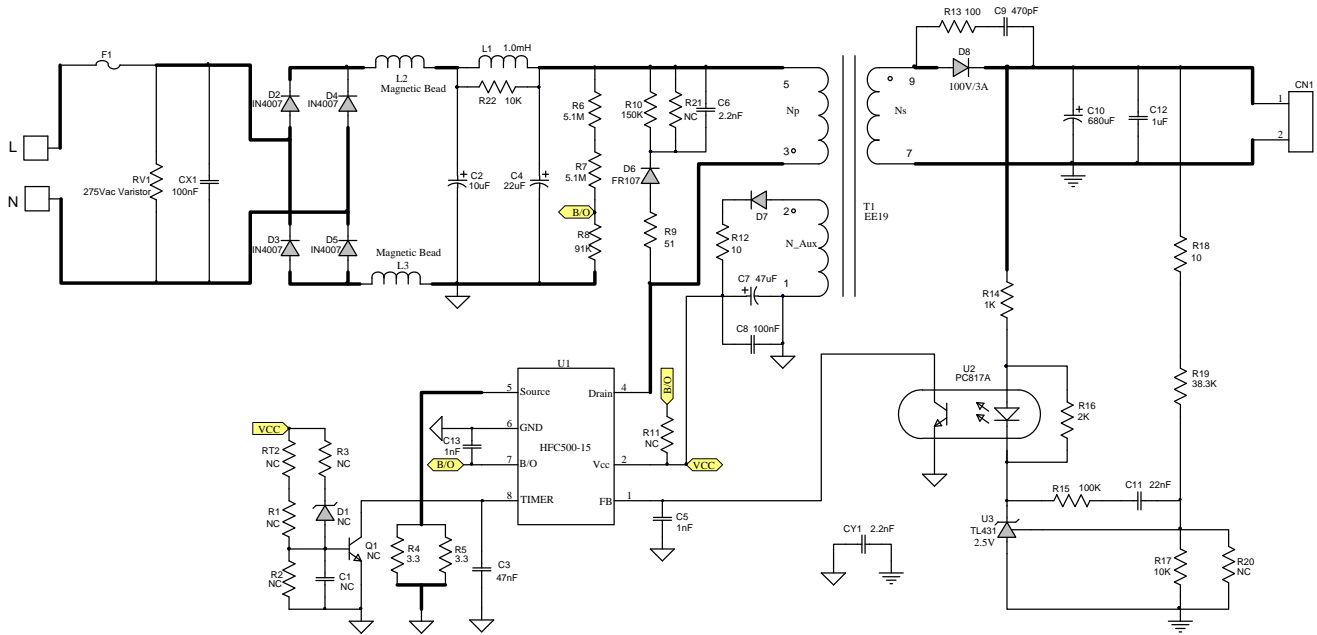
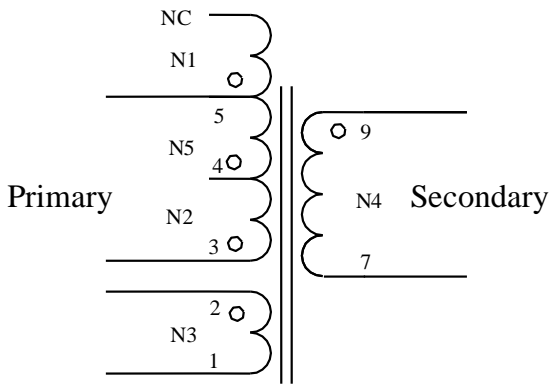
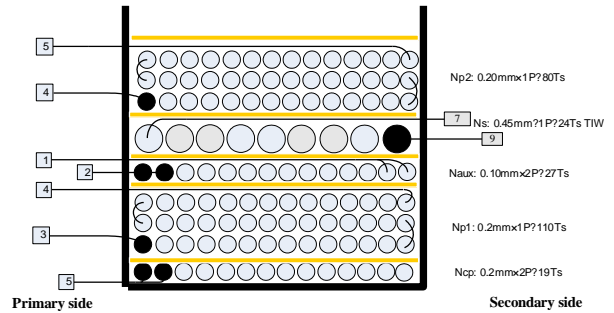

Figure 14: Example of a Typical Application



Note:  
 Ⓞ : Start Point  
 Cut 4<sup>th</sup>, 8<sup>th</sup> Pin after Winding

a) Connection Diagram



Primary side  
 Note:  
 ● Start Winding Point  
 — Tape  
 One tape between each winding

b) Winding Diagram

Figure 15: Transformer Structure

**Table 2: Winding Order**

<b>Tape (T)</b>	<b>Winding</b>	<b>Start-End</b>	<b>Wire Size (<math>\phi</math>)</b>	<b>Turns (T)</b>	<b>Tube</b>
0	N1	5 → NC	0.20mm*2	19	No
1	N2	3 → 4	0.20mm*1	110	Matching with wire
1	N3	2 → 1	0.10mm*2	27	Matching with wire
1	N4	9 → 7	0.45mm*1 TIW	24	No
1	N5	4 → 5	0.20mm*1	80	Matching with wire

FLOW CHART

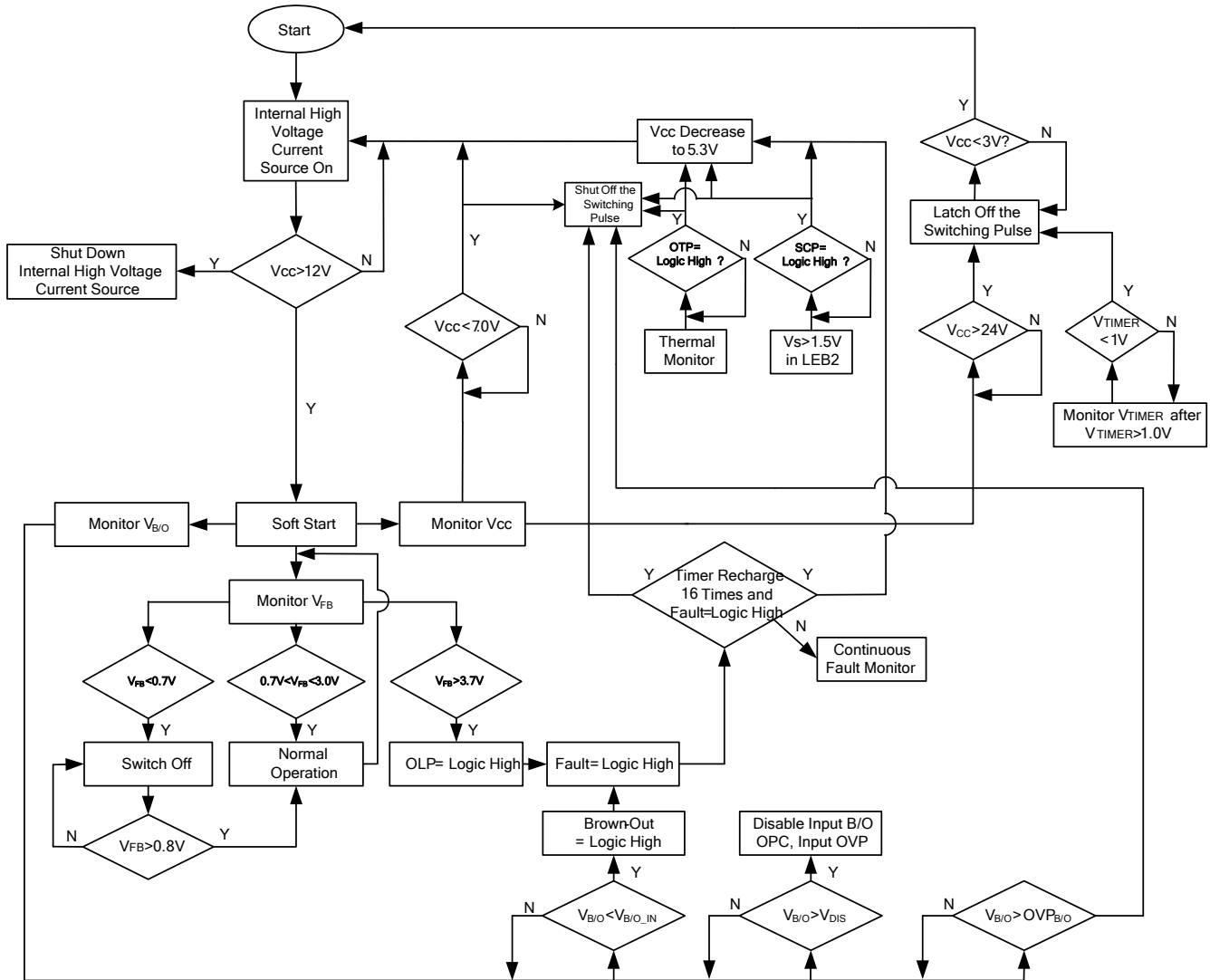

UVLO, brown-out, OTP & OLP are auto restart; OVP on VCC, and latch-off on TIMER are latch mode. To release from the latch condition, unplug from the main input.

Figure 16: Control Flow Chart

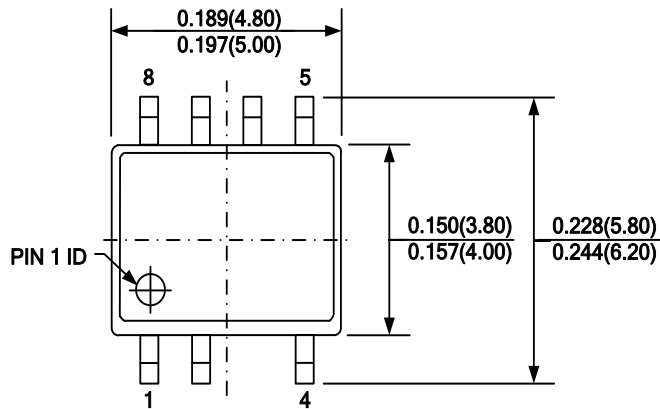
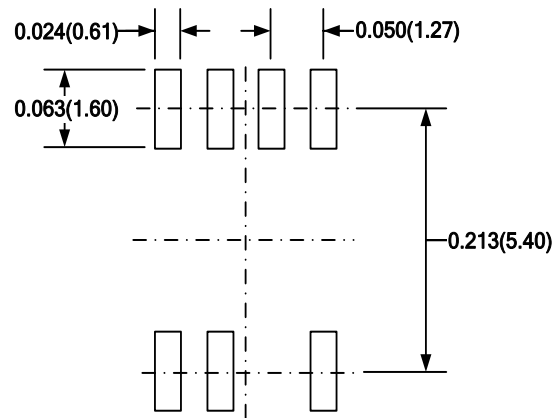
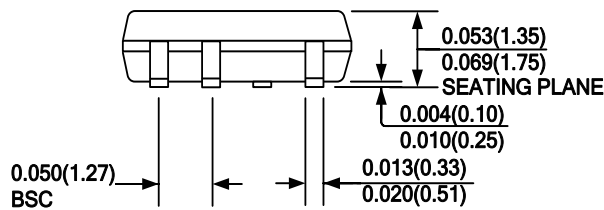
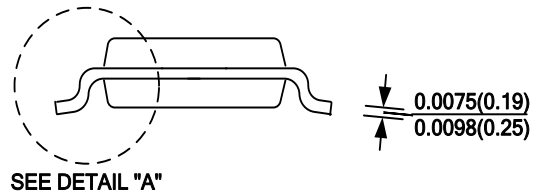
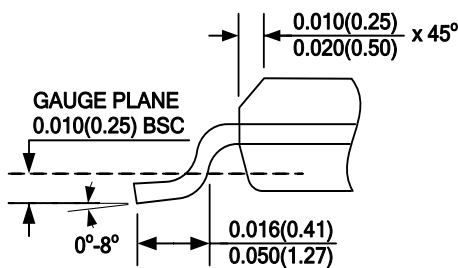
**PACKAGE INFORMATION**
**SOIC8-7B**

**TOP VIEW**

**RECOMMENDED LAND PATTERN**

**FRONT VIEW**

**SIDE VIEW**

**DETAIL "A"**
**NOTE:**

- 1) CONTROL DIMENSION IS IN INCHES. DIMENSION IN BRACKET IS IN MILLIMETERS.
- 2) PACKAGE LENGTH DOES NOT INCLUDE MOLD FLASH, PROTRUSIONS, OR GATE BURRS.
- 3) PACKAGE WIDTH DOES NOT INCLUDE INTERLEAD FLASH OR PROTRUSIONS.
- 4) LEAD COPLANARITY (BOTTOM OF LEADS AFTER FORMING) SHALL BE 0.004" INCHES MAX.
- 5) JEDEC REFERENCE IS MS-012.
- 6) DRAWING IS NOT TO SCALE.

**NOTICE:** The information in this document is subject to change without notice. Please contact MPS for current specifications. Users should warrant and guarantee that third party Intellectual Property rights are not infringed upon when integrating MPS products into any application. MPS will not assume any legal responsibility for any said applications.