

N-Channel Enhancement Mode MOSFET

TDM3426B

**DESCRIPTION**

The TDM3426B uses advanced trench technology to provide excellent RDS(ON) and low gate charge. This device is suitable for use as a load switch or in PWM applications.

**GENERAL FEATURES**

- RDS(ON) < 16mΩ @ VGS=4.5V  
RDS(ON) < 10mΩ @ VGS=10V
- High Power and current handling capability
- Lead free product is available
- Surface Mount Package

**Application**

- PWM applications
- Load switch
- Power management

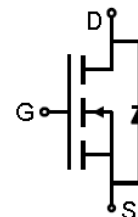

Schematic diagram

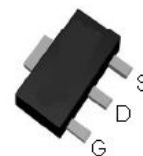

Top View SOT-89

泰德半导体--提供样品，技术支持 **13418601901 QQ409545144**

ABSOLUTE MAXIMUM RATINGS(TA=25°C unless otherwise noted)

Parameter	Symbol	Limit	Unit
Drain-Source Voltage	V <sub>DS</sub>	30	V
Gate-Source Voltage	V <sub>GS</sub>	±20	V
Diode Continuous Forward Current	I <sub>S</sub> (T <sub>C</sub> =25°C)	5	A
Continuous Drain Current (Note 1)	I <sub>D</sub> (T <sub>C</sub> =25°C)	18	A
Pulse Drain Current Tested	I <sub>DM</sub> (T <sub>A</sub> =25°C)	36	A
Maximum Power Dissipation	P <sub>D</sub> (T <sub>C</sub> =25°C)	20	W
Maximum Power Dissipation	P <sub>D</sub> (T <sub>A</sub> =25°C)	3.5	W
	P <sub>D</sub> (T <sub>A</sub> =70°C)	2.2	W
Thermal Resistance,Junction-to-Ambient(t<10s)	R <sub>θJA</sub>	35	°C/W
Maximum Operating Junction Temperature	T <sub>J</sub>	150	°C
Storage Temperature Range	T <sub>STG</sub>	-55 To 150	°C

NOTES:

1. Max continuous current is limited by bonding wire.

## N-Channel Enhancement Mode MOSFET

## TDM3426B

ELECTRICAL CHARACTERISTICS ( $T_A=25^{\circ}\text{C}$  unless otherwise noted)

Parameter	Symbol	Condition	Min	Typ	Max	Unit
OFF CHARACTERISTICS						
Drain-Source Breakdown Voltage	$BV_{DSS}$	$V_{GS}=0V, I_D=250\mu A$	30	-	-	V
Zero Gate Voltage Drain Current	$I_{DSS}$	$V_{DS}=24V, V_{GS}=0V$	-	-	1	$\mu A$
Gate-Body Leakage Current	$I_{GSS}$	$V_{GS}=\pm 20V, V_{DS}=0V$	-	-	$\pm 10$	$\mu A$
ON CHARACTERISTICS (Note 2)						
Gate Threshold Voltage	$V_{GS(th)}$	$V_{DS}=V_{GS}, I_D=250\mu A$	1.4	1.8	2.5	V
Drain-Source On-State Resistance	$R_{DS(on)}$	$V_{GS}=10V, I_D=10A$	-	8.2	10	$m\Omega$
		$V_{GS}=4.5V, I_D=8A$	-	12.3	16	$m\Omega$
DYNAMIC CHARACTERISTICS (Note 3)						
Input Capacitance	$C_{iss}$	$V_{DS}=15V, V_{GS}=0V, F=1.0MHz$	-	450	600	PF
Output Capacitance	$C_{oss}$		-	318	-	PF
Reverse Transfer Capacitance	$C_{rss}$		-	22	-	PF
SWITCHING CHARACTERISTICS (Note 3)						
Turn-on Delay Time	$t_{d(on)}$	$V_{DS}=15V, R_L=15\Omega, V_{GEN}=10V, R_G=6\Omega, I_D=1A$	-	8.5	16	nS
Turn-on Rise Time	$t_r$		-	10	18	nS
Turn-Off Delay Time	$t_{d(off)}$		-	14	26	nS
Turn-Off Fall Time	$t_f$		-	10.6	19	nS
Total Gate Charge	$Q_g$	$V_{DS}=15V, I_D=10A, V_{GS}=10V$	-	8	12	nC
Gate-Source Charge	$Q_{gs}$		-	1.6	-	nC
Gate-Drain Charge	$Q_{gd}$		-	1.2	-	nC
Body Diode Reverse Recovery Time	$T_{rr}$	$I_{DS}=10A, di/dt=100A/\mu s$	-	20.5	-	nS
Body Diode Reverse Recovery Charge	$Q_{rr}$		-	7.2	-	nC
DRAIN-SOURCE DIODE CHARACTERISTICS						
Diode Forward Voltage (Note 2)	$V_{SD}$	$V_{GS}=0V, I_S=5A$	-	0.8	1.1	V

## NOTES:

- Pulse Test: Pulse Width  $\leq 300\mu s$ , Duty Cycle  $\leq 2\%$ .
- Guaranteed by design, not subject to production testing

Typical Operating Characteristics

Power Dissipation

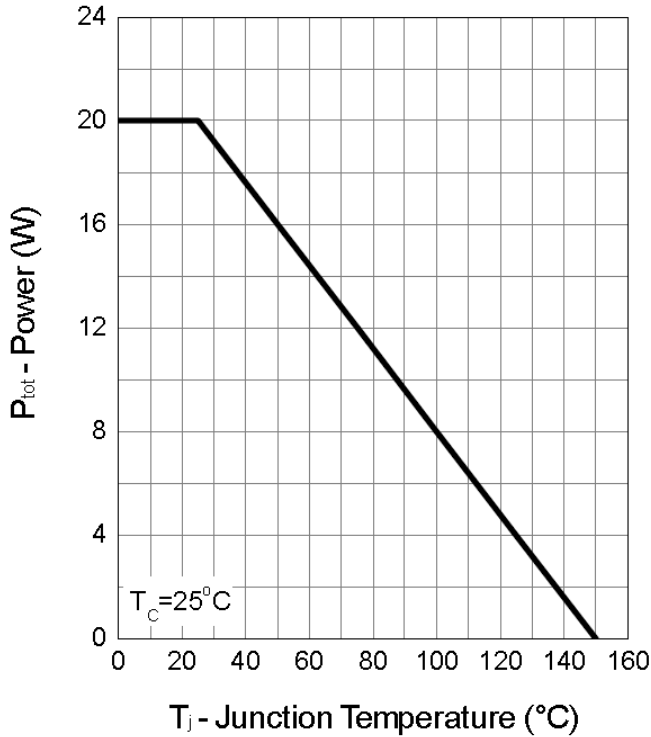

Drain Current

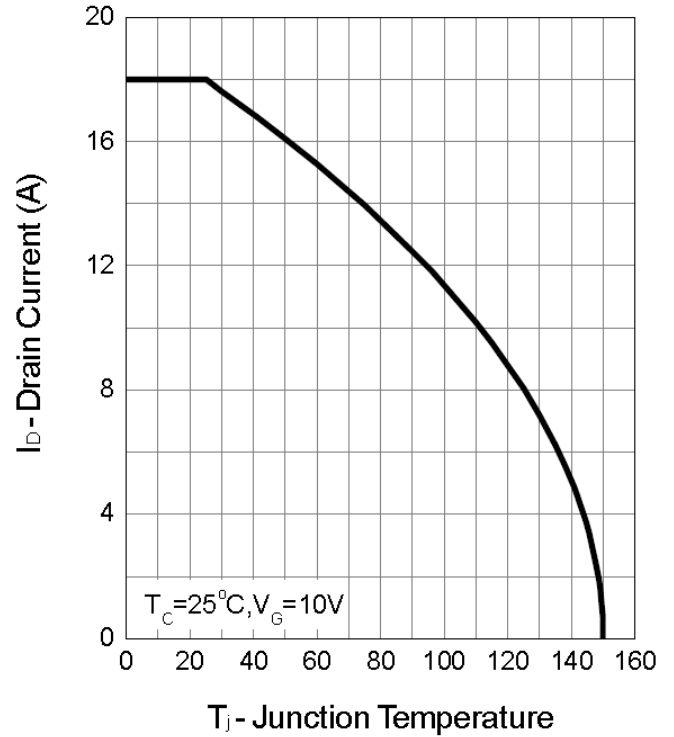

Safe Operation Area

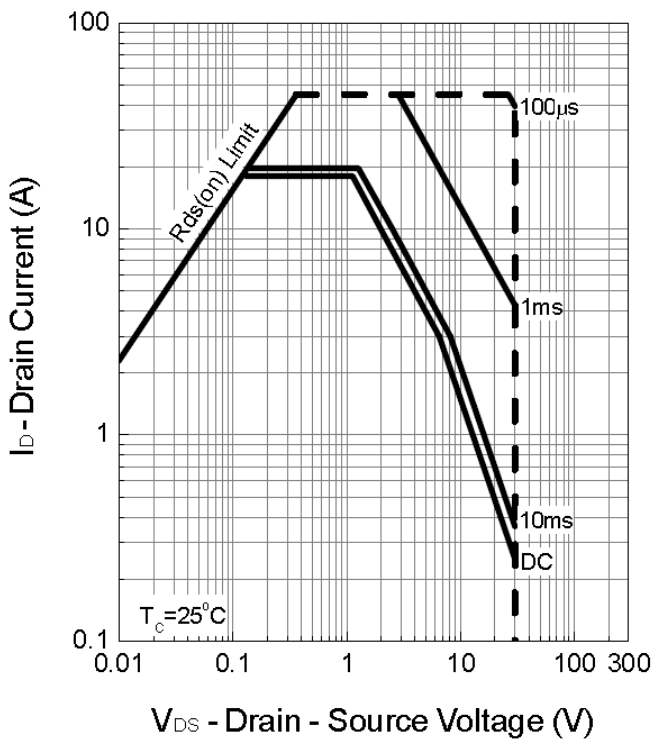

Thermal Transient Impedance

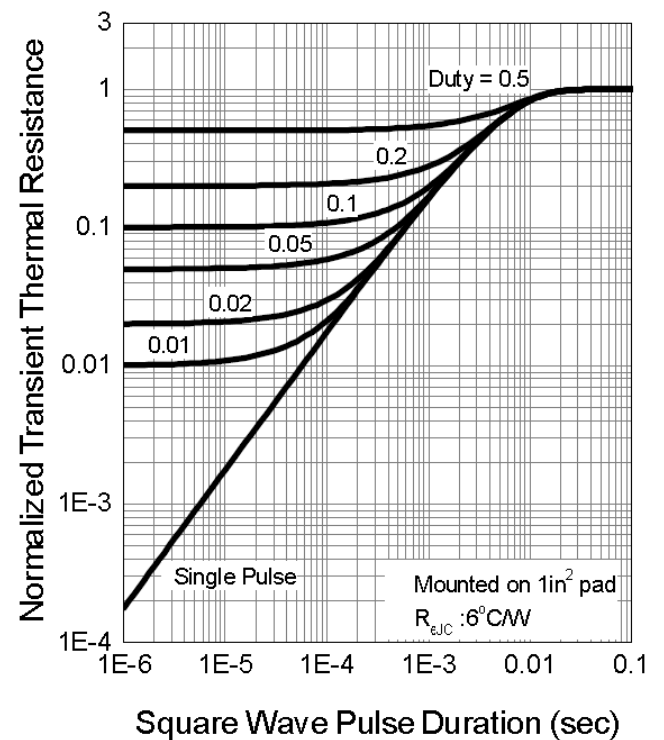

Typical Operating Characteristics(Cont.)

Safe Operation Area

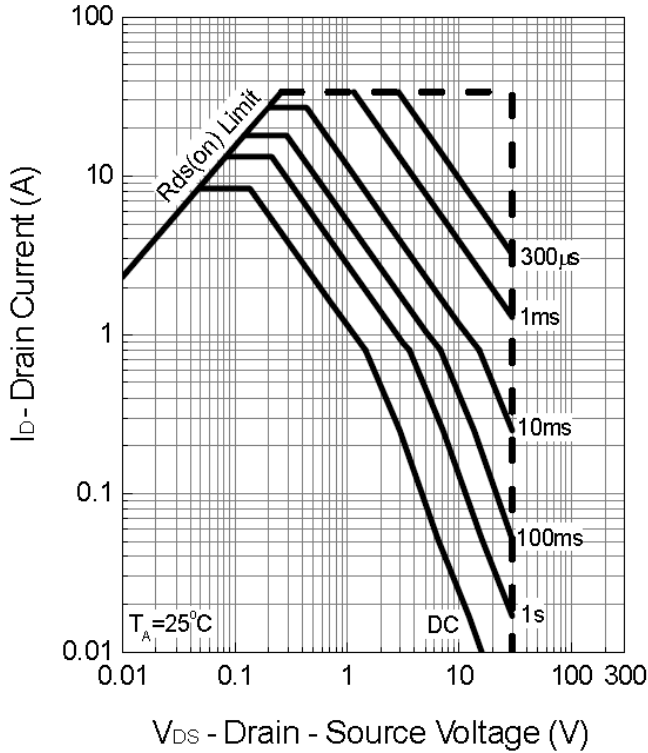

Thermal Transient Impedance

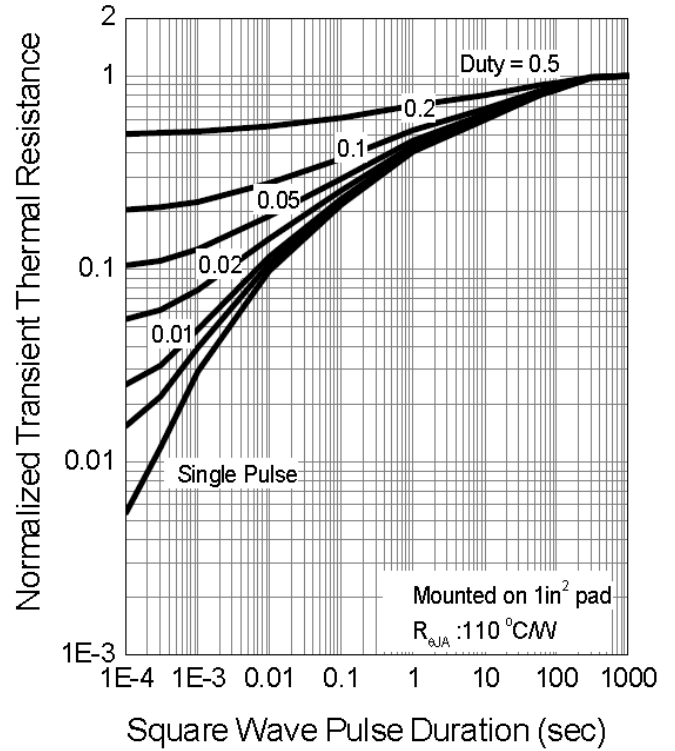

Output Characteristics

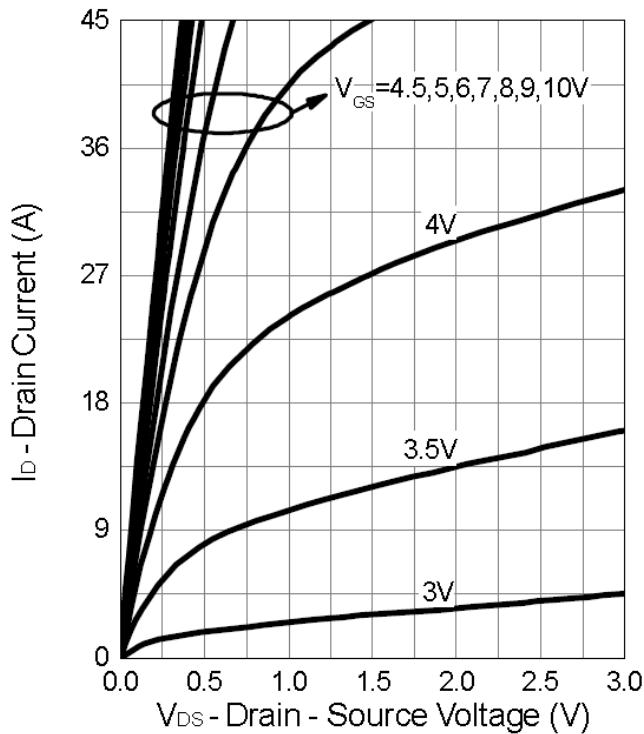

Drain-Source On Resistance

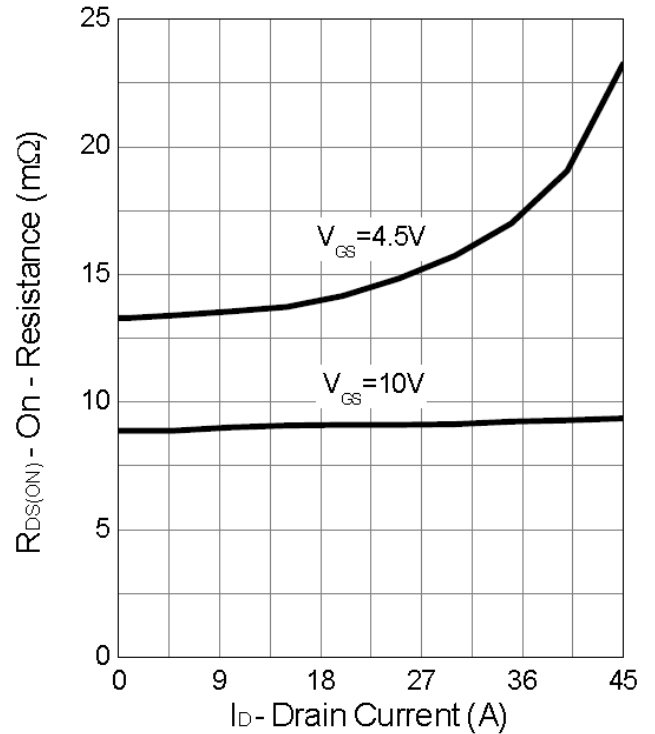

Typical Operating Characteristics (Cont.)

Gate-Source On Resistance

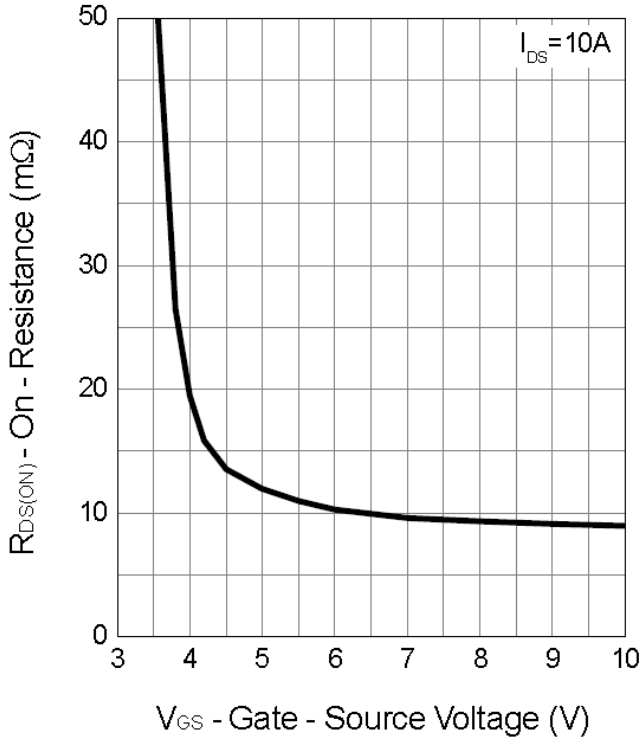

Gate Threshold Voltage

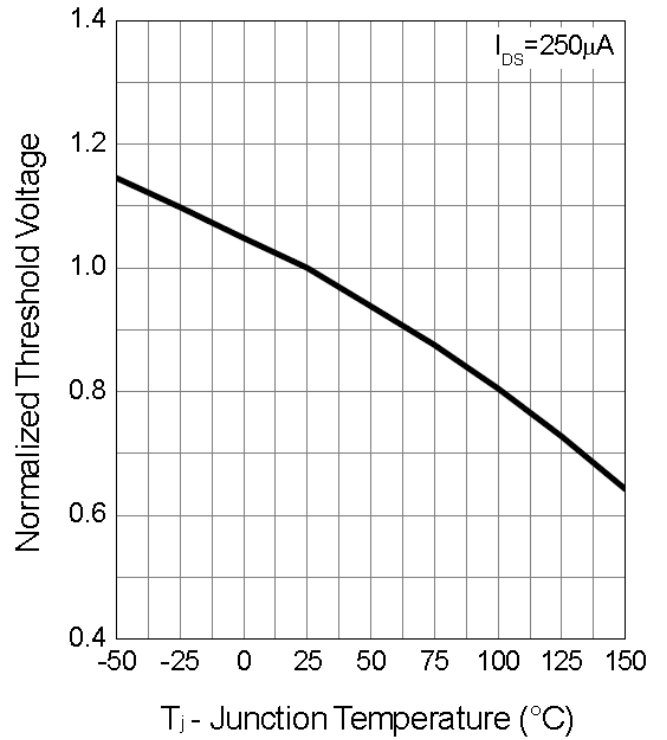

Drain-Source On Resistance

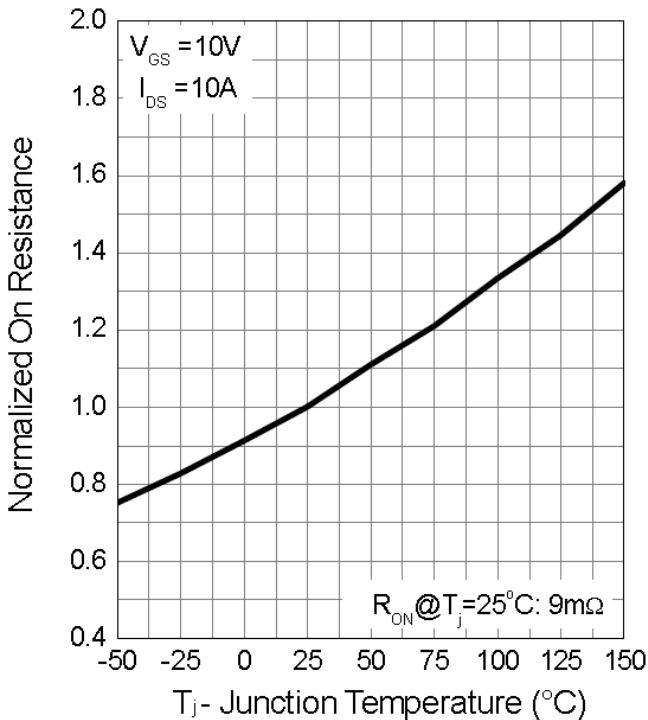

Source-Drain Diode Forward

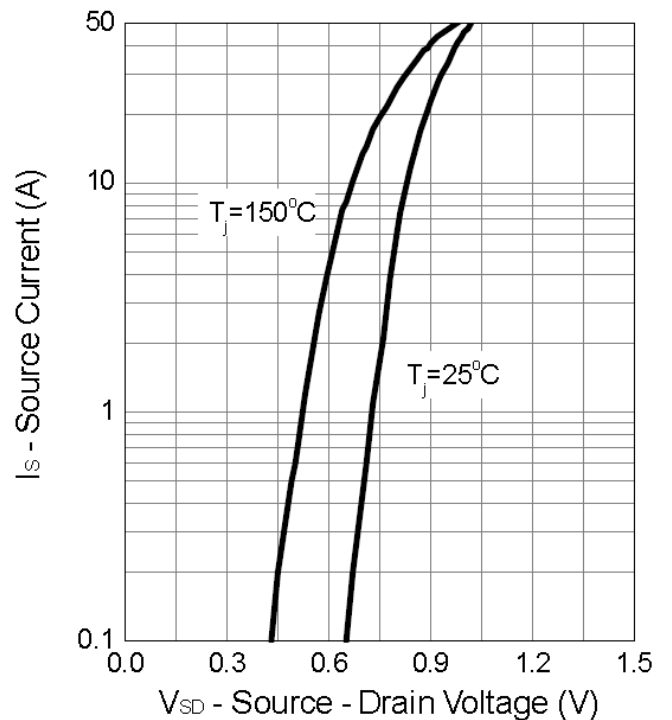

Typical Operating Characteristics (Cont.)

Capacitance

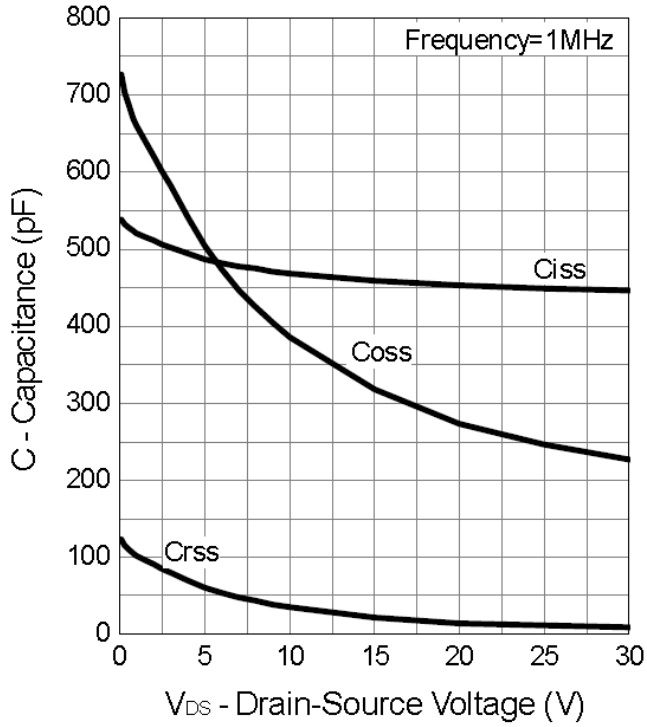

Gate Charge

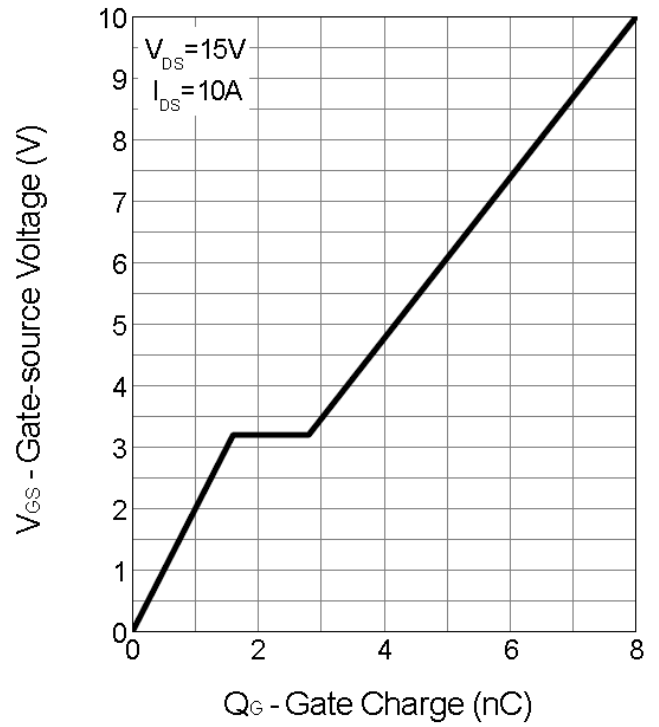

Package Information

SOT89-3 Package

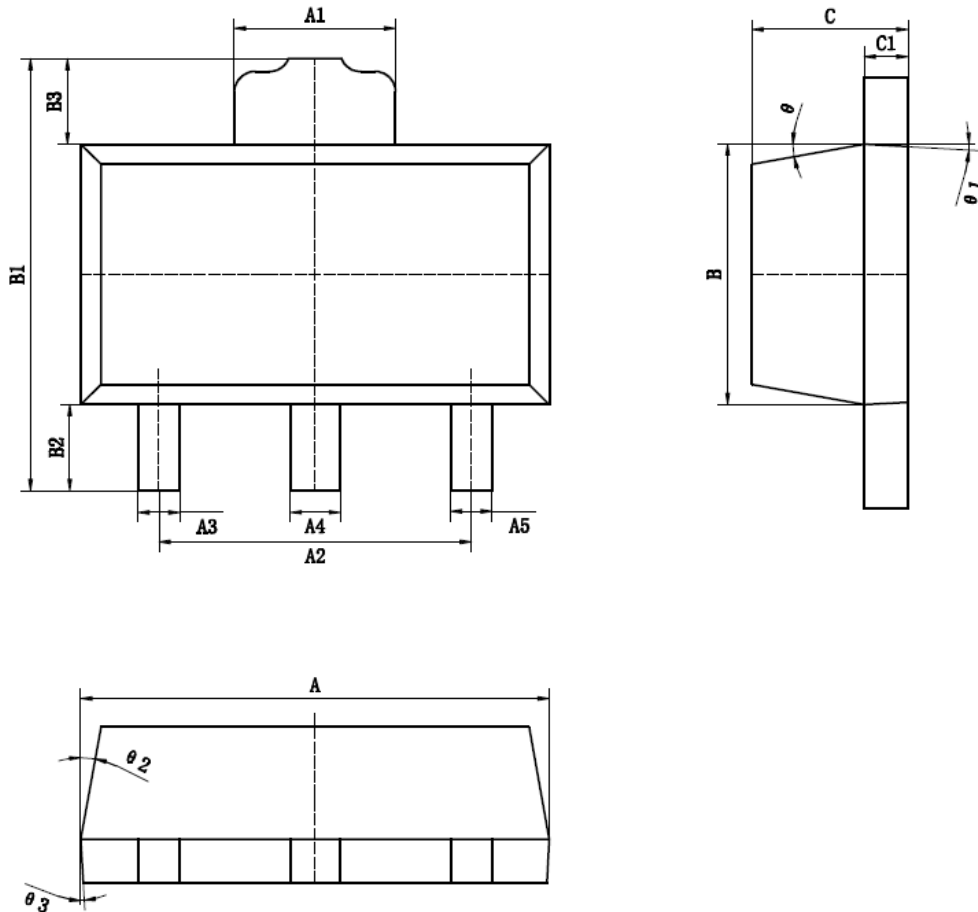

标注	尺寸	最小 (mm)	最大 (mm)	标注	尺寸	最小 (mm)	最大 (mm)
	A	4.40	4.60		B3	0.82	0.83
	A1	1.65	1.75		C	1.40	1.60
	A2	2.95	3.05		C1	0.35	0.45
	A3	0.35	0.45		θ	6° TYP4	
	A4	0.43	0.53		θ 1	3° TYP4	
	A5	0.35	0.45		θ 2	6° TYP4	
	B	2.40	2.60		θ 3	3° TYP4	
	B1	4.05	4.25				
	B2	0.82	0.83				

Design Notes