

Ref: HO 8-NP, HO 15-NP, HO 25-NP

For the electronic measurement of current: DC, AC, pulsed..., with galvanic separation between the primary and the secondary circuit.

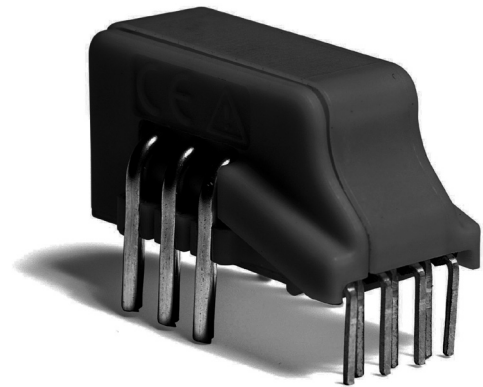

## Features

- Hall effect measuring principle
- Multirange current transducer through PCB pattern lay-out
- Galvanic separation between primary and secondary circuit
- Insulated test voltage 4300 V
- Low power consumption
- Extremely low profile 12 mm
- Single power supply +5 V
- Fixed offset & sensitivity
- Over-current detect  $2.63 \times I_{PN}$  (peak value)
- Memory check.

## Advantages

- Small size and space saving
- Only one design for wide primary current range
- High immunity to external interference
- 8 mm creepage /clearance
- High insulation capability
- Fast response.

## Applications

- AC variable speed drives
- Static converters for DC motor drives
- Battery supplied applications
- Uninterruptible Power Supplies (UPS)
- Switched Mode Power Supplies (SMPS)
- Power supplies for welding applications
- The solar inverter on DC side of the inverter (MPPT)
- Combiner box.

## Standards

- EN 50178: 1997
- IEC 61010-1: 2010
- IEC 61326-1: 2012
- UL 508: 2010.

## Application Domain

- Industrial.

## Absolute maximum ratings

Parameter	Symbol	Unit	Value
Supply voltage (not operating)	$U_C$	V	6.5
Primary conductor temperature	$T_B$	°C	120
ESD rating, Human Body Model (HBM)	$U_{ESD}$	kV	2

Stresses above these ratings may cause permanent damage. Exposure to absolute maximum ratings for extended periods may degrade reliability.

## UL 508: Ratings and assumptions of certification

File # E189713 Volume: 2 Section: 5

### Standards

- CSA C22.2 NO. 14-10 INDUSTRIAL CONTROL EQUIPMENT - Edition 11 - Revision Date 2011/08/01
- UL 508 STANDARD FOR INDUSTRIAL CONTROL EQUIPMENT - Edition 17 - Revision Date 2010/04/15

### Ratings

Parameter	Symbol	Unit	Value
Primary involved potential		V AC/DC	600
Max surrounding air temperature	$T_A$	°C	105
Primary current	$I_P$	A	According to series primary currents
Secondary supply voltage	$U_C$	V DC	5
Output voltage	$V_{out}$	V	0 to 5

### Conditions of acceptability

When installed in the end-use equipment, consideration shall be given to the following:

- 1 - These devices have been evaluated for overvoltage category III and for use in pollution degree 2 environment.
- 2 - A suitable enclosure shall be provided in the end-use application.
- 3 - The terminals have not been evaluated for field wiring.
- 4 - These devices have been evaluated for use in 105 °C maximum surrounding air temperature.
- 5 - The secondary (Sensing) circuit is intended to be supplied by a Isolated Secondary Circuit - Limited voltage circuit defined by UL 508 paragraph 32.5. The maximum open circuit voltage potential available to the circuit and overcurrent protection shall be evaluated in the end use application.
- 6 - These devices are intended to be mounted on a printed wiring board of end-use equipment. The suitability of the connections (including spacings) shall be determined in the end-use application.
- 7 - Primary terminals shall not be straightened since assembly of housing case depends upon bending of the terminals.
- 8 - Any surface of polymeric housing have not been evaluated as insulating barrier.
- 9 - Low voltage circuits are intended to be powered by a circuit derived from an isolating source (such as a transformer, optical isolator, limiting impedance or electro-mechanical relay) and having no direct connection back to the primary circuit (other than through the grounding means).

### Marking

Only those products bearing the UL or UR Mark should be considered to be Listed or Recognized and covered under UL's Follow-Up Service. Always look for the Mark on the product.

**Insulation coordination**

Parameter	Symbol	Unit	Value	Comment
Rms voltage for AC isolation test 50/60 Hz/1 min	$U_d$	kV	4.3	
Impulse withstand voltage 1.2/50 $\mu$ s	$\hat{U}_w$	kV	8	
Partial discharge extinction rms voltage @ 10 pC	$U_e$	V	1650	
Clearance (pri. - sec.)	$d_{Cl}$	mm	8	Shortest distance through air
Creepage distance (pri. - sec.)	$d_{Cp}$	mm	8	Shortest path along device body
Case material			V0 according to UL 94	
Comparative tracking index	$CTI$		600	
Application example	-	-	600 V CAT III PD2	Reinforced insulation, non uniform field according to EN 50178
Application example	-	-	300 V CAT III PD2	Reinforced insulation, non uniform field according to IEC 61010
Application example	-	-	1000 V CAT III PD2	Simple insulation, non uniform field according to EN 50178, IEC 61010

**Environmental and mechanical characteristics**

Parameter	Symbol	Unit	Min	Typ	Max	Comment
Ambient operating temperature	$T_A$	$^{\circ}$ C	-40		105	
Ambient storage temperature	$T_S$	$^{\circ}$ C	-40		105	
Surrounding temperature according to UL 508		$^{\circ}$ C			105	
Mass	$m$	g		5		

**Electrical data HO 8-NP-0000**

 At  $T_A = 25\text{ °C}$ ,  $U_C = +5\text{ V}$ ,  $N_P = 3$  turns,  $R_L = 10\text{ K}\Omega$  unless otherwise noted (see Min, Max, typ. definition paragraph in page 12).

Parameter	Symbol	Unit	Min	Typ	Max	Comment
Primary nominal rms current	$I_{PN}$	At		8		
Primary current, measuring range	$I_{PM}$	At	-20		20	
Number of primary turns	$N_P$			1,2,3		
Supply voltage	$U_C$	V	4.5	5	5.5	
Current consumption	$I_C$	mA		19	25	
Reference voltage	$V_{ref}$	V	2.475	2.5	2.525	Internal reference
External reference voltage	$V_{ref}$	V	0.5		2.65	
Output voltage range @ $I_{PM}$	$V_{out} - V_{ref}$	V	-2		2	
Output voltage @ $I_P = 0\text{ A}$	$V_{out}$	V		$V_{ref} + V_{OE}$		
Electrical offset voltage	$V_{OE}$	mV	-7		7	
Temperature coefficient of $V_{ref}$	$TCV_{ref}$	ppm/K			±160	-20 °C .. 85 °C Internal reference
					±190	-40 °C .. 105 °C Internal reference
Temperature coefficient of $V_{OE}$	$TCV_{OE}$	mV/K			±0.088	-20 °C .. 85 °C
					±0.095	-40 °C .. 105 °C
Theoretical sensitivity	$G_{th}$	mV/A		100		800 mV/ $I_{PN}$ @ $U_C = 5\text{ V}$
Sensitivity error	$\epsilon_G$	%			±0.5	Factory adjustment
Temperature coefficient of G	$TCG$	ppm/K			±200	-40 °C .. 85 °C
					±220	-40 °C .. 105 °C
Linearity error 0 .. $I_{PN}$	$\epsilon_L$	% of $I_{PN}$			±0.5	@ $U_C = 5\text{ V}$
Linearity error 0 .. $I_{PM}$	$\epsilon_L$	% of $I_{PM}$			±0.8	@ $U_C = 5\text{ V}$
Gain error with respect to $U_C \pm 10\%$		%/%			±0.05	Gain error per $U_C$ drift
Magnetic offset voltage @ $I_P = 0$ after $2.5 \times I_{PN}$	$V_{OM}$	mV			±6	
Reaction time @ 10 % of $I_{PN}$	$t_{ra}$	µs			2	$di/dt = I_{PN}/\mu s$
Response time @ 90 % of $I_{PN}$	$t_r$	µs			3.5	$di/dt = I_{PN}/\mu s$
Frequency bandwidth (-3 dB)	$BW$	kHz		250		
Output rms voltage noise (spectral density) (DC .. 100 kHz)	$e_{no}$	µV/√Hz			32.9	@ $U_C = 5\text{ V}$
Output voltage noise (DC .. 20 MHz)	$V_{no}$	mVpp		80		
Standby pin "0" level		V			0.3	
Standby pin "1" level		V	$U_C - 0.3$			
Time to switch from standby to normal mode		µs			20	
Over-current detect		At	$2.6 \times I_{PN}$	$2.9 \times I_{PN}$	$3.2 \times I_{PN}$	peak value
Accuracy @ $I_{PN}$	X	% of $I_{PN}$			±1	$= \epsilon_G + \epsilon_L$
Accuracy @ $I_{PN}$ @ $T_A = +85\text{ °C}$	X	% of $I_{PN}$			±2.9	See formula note <sup>1)</sup>
Accuracy @ $I_{PN}$ @ $T_A = +105\text{ °C}$	X	% of $I_{PN}$			±3.8	See formula note <sup>1)</sup>

Note: <sup>1)</sup> Accuracy @  $I_P$  and  $X_{TA} = \pm [X + (TCG/10000) \cdot (T_A - 25) + TCV_{OE} \cdot 100 \cdot (T_A - 25) / (G_{th} \cdot I_P)]$ .

**Electrical data HO 15-NP-0000**

 At  $T_A = 25\text{ °C}$ ,  $U_C = +5\text{ V}$ ,  $N_P = 3\text{ turns}$ ,  $R_L = 10\text{ K}\Omega$  unless otherwise noted (see Min, Max, typ. definition paragraph in page 12).

Parameter	Symbol	Unit	Min	Typ	Max	Comment
Primary nominal rms current	$I_{PN}$	At		15		
Primary current, measuring range	$I_{PM}$	At	-37.5		37.5	
Number of primary turns	$N_P$			1,2,3		
Supply voltage	$U_C$	V	4.5	5	5.5	
Current consumption	$I_C$	mA		19	25	
Reference voltage	$V_{ref}$	V	2.475	2.5	2.525	Internal reference
External reference voltage	$V_{ref}$	V	0.5		2.65	
Output voltage range @ $I_{PM}$	$V_{out} - V_{ref}$	V	-2		2	
Output voltage @ $I_P = 0\text{ A}$	$V_{out}$	V		$V_{ref} + V_{OE}$		
Electrical offset voltage	$V_{OE}$	mV	-5		5	
Temperature coefficient of $V_{ref}$	$TCV_{ref}$	ppm/K			±160	-20 °C .. 85 °C Internal reference
					±190	-40 °C .. 105 °C Internal reference
Temperature coefficient of $V_{OE}$	$TCV_{OE}$	mV/K			±0.075	
Theoretical sensitivity	$G_{th}$	mV/A		53.33		800 mV/ $I_{PN}$ , @ $U_C = 5\text{ V}$
Sensitivity error	$\epsilon_G$	%			±0.5	Factory adjustment
Temperature coefficient of $G$	$TCG$	ppm/K			±200	
Linearity error 0 .. $I_{PN}$	$\epsilon_L$	% of $I_{PN}$			±0.5	@ $U_C = 5\text{ V}$
Linearity error 0 .. $I_{PM}$	$\epsilon_L$	% of $I_{PM}$			±0.8	@ $U_C = 5\text{ V}$
Gain error with respect to $U_C \pm 10\%$		%/%			±0.05	Gain error per $U_C$ drift
Magnetic offset voltage @ $I_P = 0$ after $2.5 \times I_{PN}$	$V_{OM}$	mV			±6	
Reaction time @ 10 % of $I_{PN}$	$t_{ra}$	µs			2	$di/dt = I_{PN}/\mu s$
Response time @ 90 % of $I_{PN}$	$t_r$	µs			3.5	$di/dt = I_{PN}/\mu s$
Frequency bandwidth (-3 dB)	$BW$	kHz		250		
Output rms voltage noise (spectral density) (DC .. 100 MHz)	$e_{no}$	µV/√Hz			17.5	
Output voltage noise (DC .. 20 MHz)	$V_{no}$	mVpp		50		
Standby pin "0" level		V			0.3	
Standby pin "1" level		V	$U_C - 0.3$			
Time to switch from standby to normal mode		µs			20	
Over-current detect		At	$2.6 \times I_{PN}$	$2.9 \times I_{PN}$	$3.2 \times I_{PN}$	peak value
Accuracy @ $I_{PN}$	X	% of $I_{PN}$			±1	= $\epsilon_G + \epsilon_L$
Accuracy @ $I_{PN}$ @ $T_A = +85\text{ °C}$	X	% of $I_{PN}$			±2.8	See formula note <sup>1)</sup>
Accuracy @ $I_{PN}$ @ $T_A = +105\text{ °C}$	X	% of $I_{PN}$			±3.4	See formula note <sup>1)</sup>

Note: <sup>1)</sup> Accuracy @  $I_P$  and  $X_{TA} = \pm [X + (TCG/10000) \cdot (T_A - 25) + TCV_{OE} \cdot 100 \cdot (T_A - 25) / (G_{th} \cdot I_P)]$ .

**Electrical data HO 25-NP-0000**

 At  $T_A = 25\text{ °C}$ ,  $U_C = +5\text{ V}$ ,  $N_P = 3$  turns,  $R_L = 10\text{ K}\Omega$  unless otherwise noted (see Min, Max, typ. definition paragraph in page 12).

Parameter	Symbol	Unit	Min	Typ	Max	Comment
Primary nominal rms current	$I_{PN}$	At		25		
Primary current, measuring range	$I_{PM}$	At	-62.5		62.5	
Number of primary turns	$N_P$			1,2,3		
Supply voltage	$U_C$	V	4.5	5	5.5	
Current consumption	$I_C$	mA		19	25	
Reference voltage	$V_{ref}$	V	2.475	2.5	2.525	Internal reference
External reference voltage	$V_{ref}$	V	0.5		2.65	
Output voltage range @ $I_{PM}$	$V_{out} - V_{ref}$	V	-2		2	
Output voltage @ $I_P = 0\text{ A}$	$V_{out}$	V		$V_{ref} + V_{OE}$		
Electrical offset voltage	$V_{OE}$	mV	-5		5	
Temperature coefficient of $V_{ref}$	$TCV_{ref}$	ppm/K			±160	-20 °C .. 85 °C Internal reference
					±190	-40 °C .. 105 °C Internal reference
Temperature coefficient of $V_{OE}$	$TCV_{OE}$	mV/K			±0.075	
Theoretical sensitivity	$G_{th}$	mV/A		32		800 mV / $I_{PN}$ @ $U_C = 5\text{ V}$
Sensitivity error	$\epsilon_G$	%			±0.5	Factory adjustment
Temperature coefficient of $G$	$TCG$	ppm/K			±200	
Linearity error 0 .. $I_{PN}$	$\epsilon_L$	% of $I_{PN}$			±0.5	@ $U_C = 5\text{ V}$
Linearity error 0 .. $I_{PM}$	$\epsilon_L$	% of $I_{PM}$			±0.8	@ $U_C = 5\text{ V}$
Gain error with respect to $U_C \pm 10\%$		%/%			±0.05	Gain error per $U_C$ drift
Magnetic offset voltage @ $I_P = 0$ after $2.5 \times I_{PN}$	$V_{OM}$	mV			±6	
Reaction time @ 10 % of $I_{PN}$	$t_{ra}$	µs			2	$di/dt = I_{PN}/\mu s$
Response time @ 90 % of $I_{PN}$	$t_r$	µs			3.5	$di/dt = I_{PN}/\mu s$
Frequency bandwidth (- 3 dB)	$BW$	kHz		250		
Output rms voltage noise (spectral density) (DC .. 100 MHz)	$e_{no}$	µV/√Hz			10.5	
Output voltage noise (DC .. 20 MHz)	$V_{no}$	mVpp		30		
Standby pin "0" level		V			0.3	
Standby pin "1" level		V	$U_C - 0.3$			
Time to switch from standby to normal mode		µs			20	
Over-current detect		At	$2.6 \times I_{PN}$	$2.9 \times I_{PN}$	$3.2 \times I_{PN}$	peak value
Accuracy @ $I_{PN}$	X	% of $I_{PN}$			±1	$= \epsilon_G + \epsilon_L$
Accuracy @ $I_{PN}$ @ $T_A = +85\text{ °C}$	X	% of $I_{PN}$			±2.8	See formula note <sup>1)</sup>
Accuracy @ $I_{PN}$ @ $T_A = +105\text{ °C}$	X	% of $I_{PN}$			±3.4	See formula note <sup>1)</sup>

Note: <sup>1)</sup> Accuracy @  $I_P$  and  $X_{TA} = \pm [X + (TCG/10000) \cdot (T_A - 25) + TCV_{OE} \cdot 100 \cdot (T_A - 25) / (G_{th} \cdot I_P)]$ .

Typical performance characteristics  $I_{PN} = 8\text{ A}$

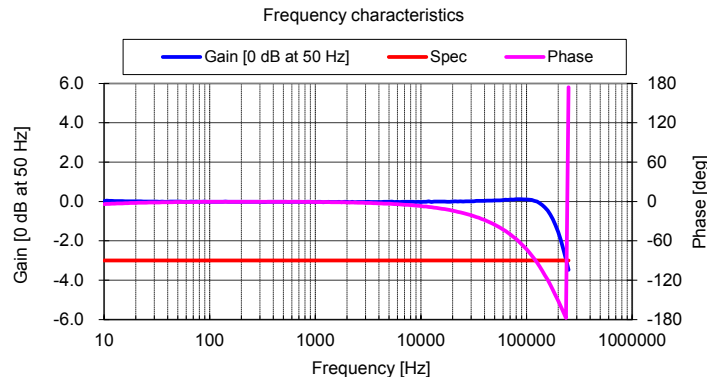
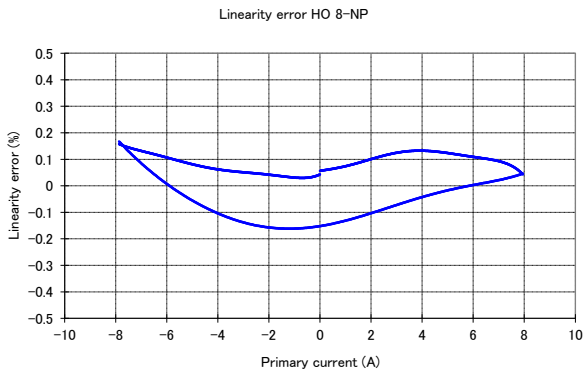

Figure 1: Linearity error

Figure 2: Frequency response

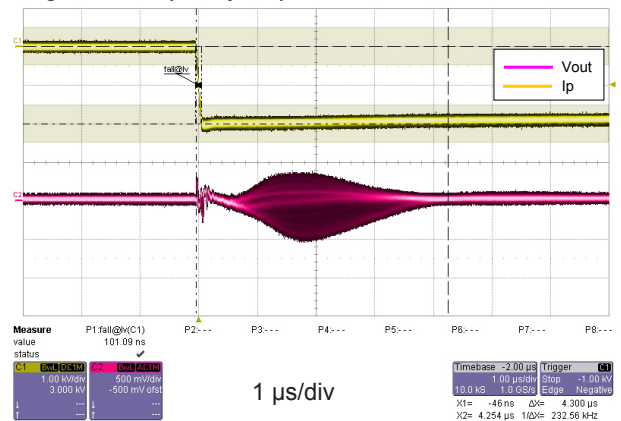
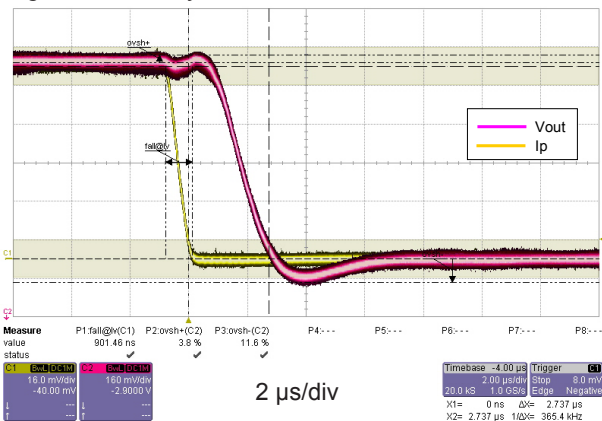

Figure 3: Step response

Figure 4: dv/dt

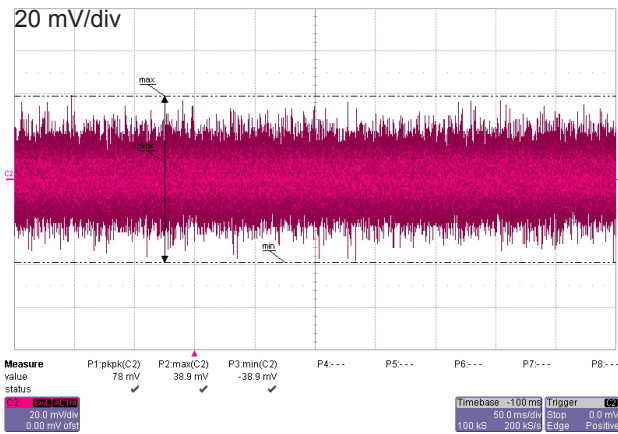

Figure 5: Output noise

Typical performance characteristics  $I_{PN} = 15 A$

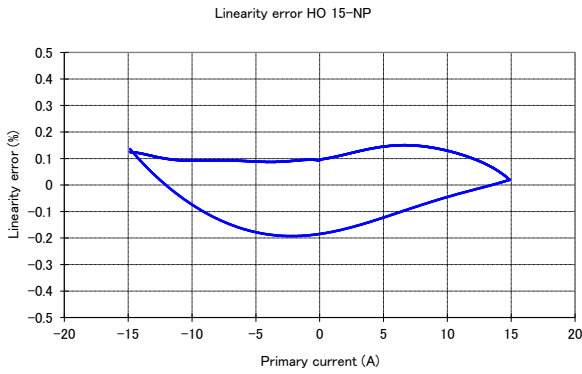

Figure 6: Linearity error

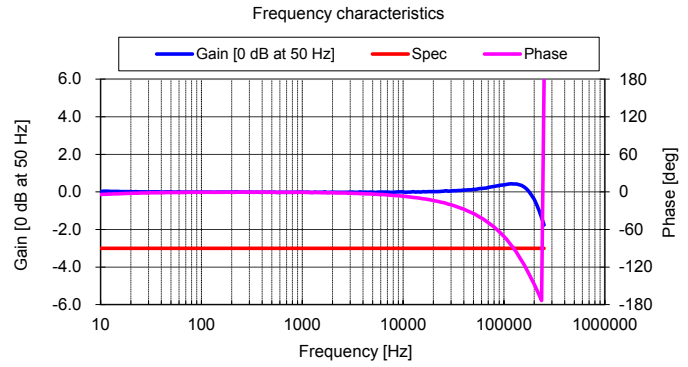

Figure 7: Frequency response

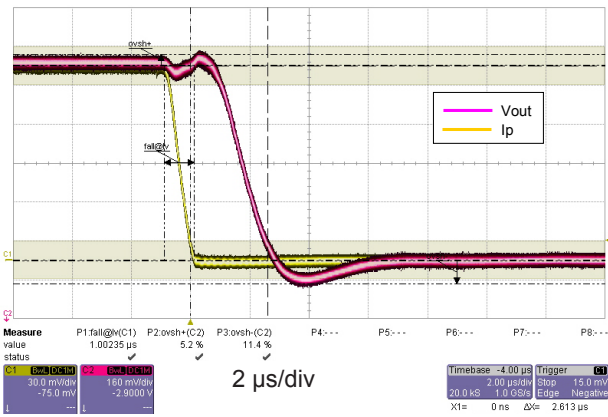

Figure 8: Step response

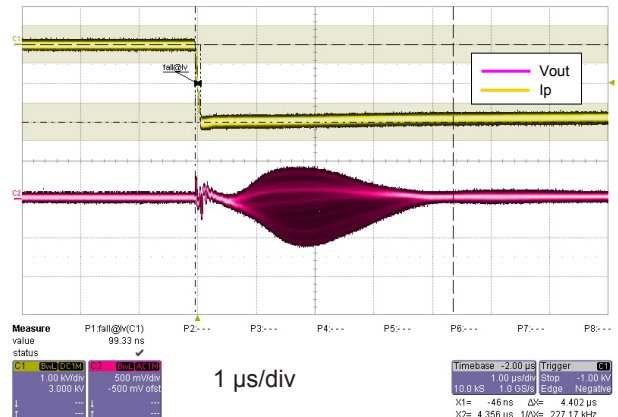

Figure 9: dv/dt

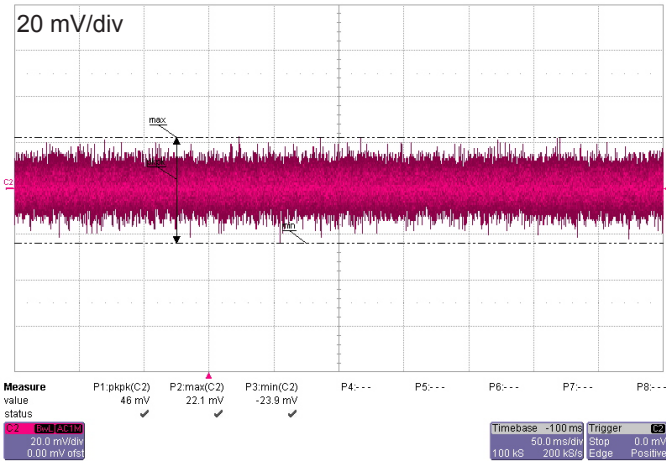

Figure 10: Output noise



Typical performance characteristics  $I_{PN} = 25\text{ A}$

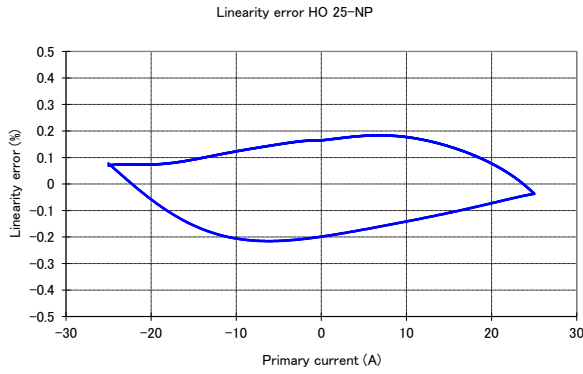

Figure 11: Linearity error

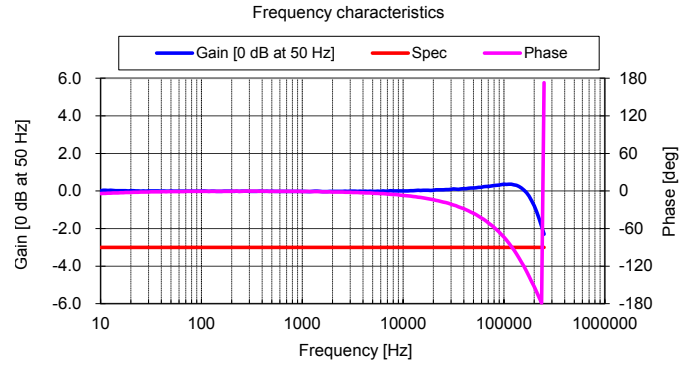

Figure 12: Frequency response

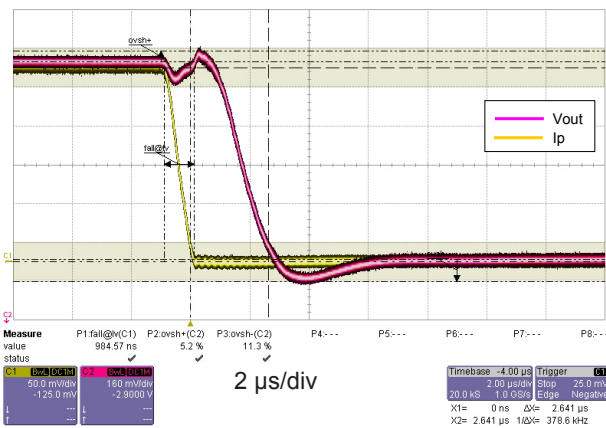

Figure 13: Step response

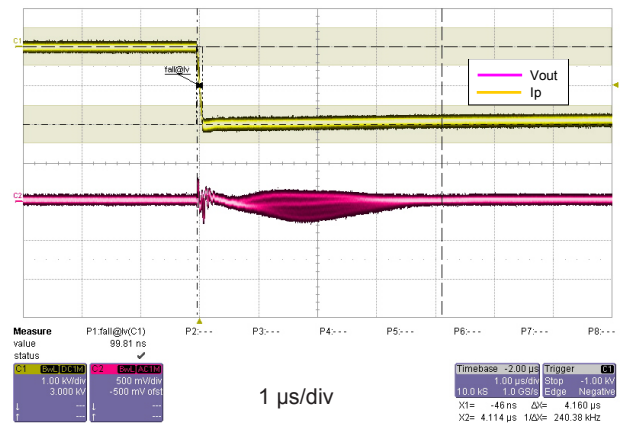

Figure 14: dv/dt

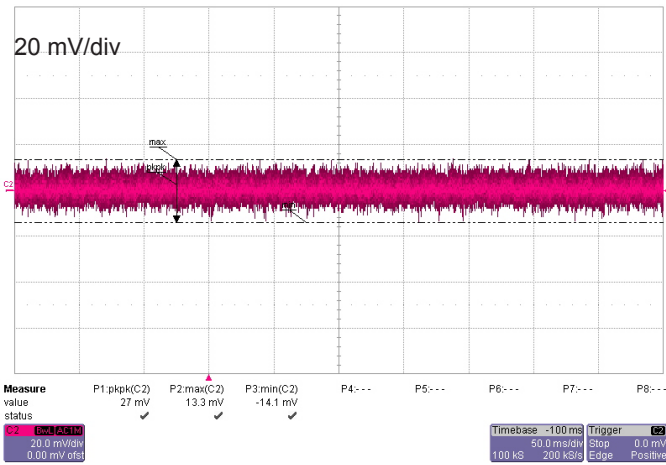

Figure 15: Output noise

Maximum continuous DC primary primary current

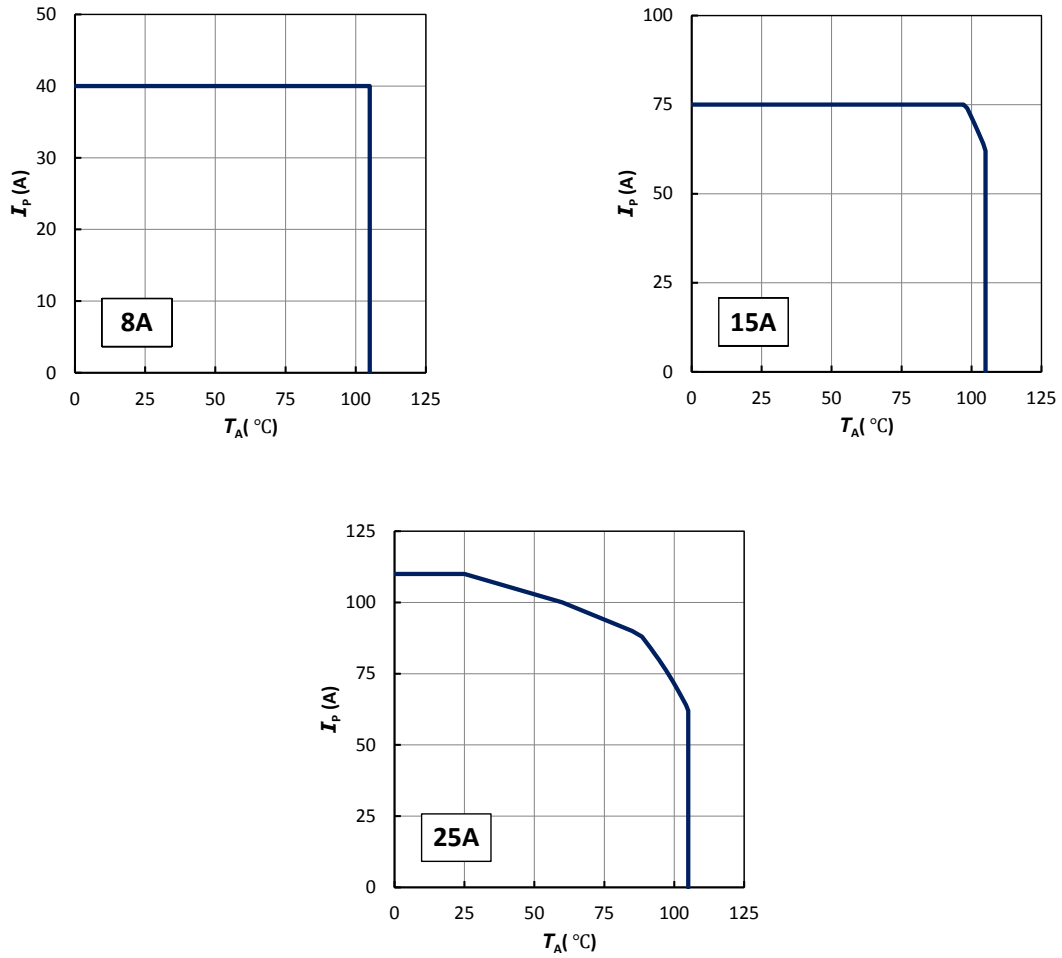
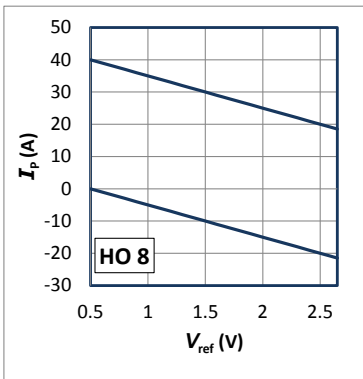

Figure 16:  $I_p$  vs  $T_A$  for HO series

**Important notice:** whatever the usage and/or application, the transducer jumper temperature shall not go above the maximum rating of 120 °C as stated in page 2 of this datasheet.

**Measuring range with external reference voltage**

*Upper limit:*

$$I_p = -10 \times V_{ref} + 45 \quad (V_{ref} = 0.5 \dots 2.65 \text{ V})$$

*Lower limit:*

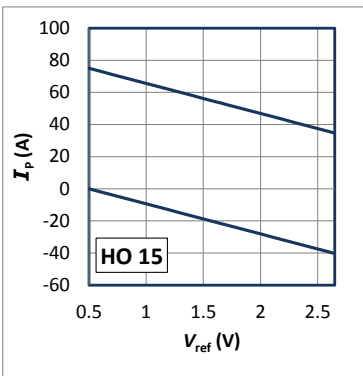
$$I_p = -10 \times V_{ref} + 5 \quad (V_{ref} = 0.5 \dots 2.65 \text{ V})$$

*Upper limit:*

$$I_p = -18.75 \times V_{ref} + 84.38 \quad (V_{ref} = 0.5 \dots 2.65 \text{ V})$$

*Lower limit:*

$$I_p = -18.75 \times V_{ref} + 9.38 \quad (V_{ref} = 0.5 \dots 2.65 \text{ V})$$

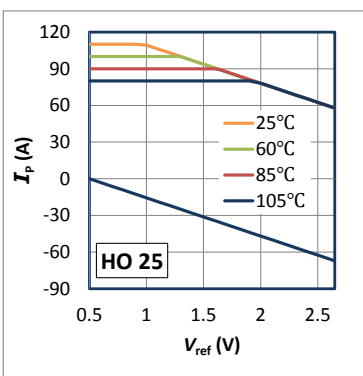
*Upper limit:*  
 $T_A = 105 \text{ }^\circ\text{C}$ 

$$I_p = 80 \quad (V_{ref} = 0.5 \dots 1.94 \text{ V})$$

$$I_p = 31.25 \times V_{ref} + 140.63 \quad (V_{ref} = 1.94 \dots 2.65 \text{ V})$$

 $T_A = 85 \text{ }^\circ\text{C}$ 

$$I_p = 90 \quad (V_{ref} = 0.5 \dots 1.62 \text{ V})$$

$$I_p = 31.25 \times V_{ref} + 140.63 \quad (V_{ref} = 1.62 \dots 2.65 \text{ V})$$

 $T_A = 60 \text{ }^\circ\text{C}$ 

$$I_p = 100 \quad (V_{ref} = 0.5 \dots 1.3 \text{ V})$$

$$I_p = 31.25 \times V_{ref} + 140.63 \quad (V_{ref} = 1.3 \dots 2.65 \text{ V})$$

 $T_A = 25 \text{ }^\circ\text{C}$ 

$$I_p = 110 \quad (V_{ref} = 0.5 \dots 0.98 \text{ V})$$

$$I_p = 31.25 \times V_{ref} + 140.63 \quad (V_{ref} = 0.98 \dots 2.65 \text{ V})$$

*Lower limit:*

$$I_p = -31.25 \times V_{ref} + 15.63 \quad (V_{ref} = 0.5 \dots 2.5 \text{ V})$$

*Example with  $V_{ref} = 0.5 \text{ V}$ :*

- The 8 A version has a measuring range from 0 A to 40 A
- The 15 A version has a measuring range from 0 A to 75 A
- The 25 A version has a measuring range from 0 A to 80 A at  $T_A = 105 \text{ }^\circ\text{C}$

*Example with  $V_{ref} = 1.5 \text{ V}$ :*



- The 8 A version has a measuring range from -10 A to 30 A
- The 15 A version has a measuring range from -18.7 A to +56.3 A
- The 25 A version has a measuring range from -31.2 A to +90 A at  $T_A = 85 \text{ }^\circ\text{C}$

## Application information

### Total primary resistance

The primary resistance is 0.36 mΩ per conductor at 25 °C.

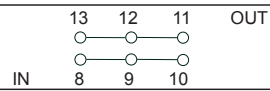
In the following table, examples of primary resistance according to the number of primary turns.

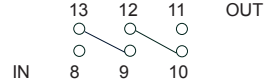
Number of primary turns	Primary resistance current rms $R_p$ [ mΩ ]	Recommended connections	Primary nominal current $I_{PN}$ [ A ]		
			8	15	25
1	0.12		8	15	25
2	0.54		4	7.5	12.5
3	1.18		2.67	5	8.33

### Definition of typical, minimum and maximum values

Minimum and maximum values for specified limiting and safety conditions have to be understood as such as well as values shown in “typical” graphs.

On the other hand, measured values are part of a statistical distribution that can be specified by an interval with upper and lower limits and a probability for measured values to lie within this interval.

Unless otherwise stated (e.g. “100 % tested”), the LEM definition for such intervals designated with “min” and “max” is that the probability for values of samples to lie in this interval is 99.73 %.

For a normal (Gaussian) distribution, this corresponds to an interval between -3 sigma and +3 sigma. If “typical” values are not obviously mean or average values, those values are defined to delimit intervals with a probability of 68.27 %, corresponding to an interval between -sigma and +sigma for a normal distribution.

Typical, maximal and minimal values are determined during the initial characterization of a product.

### Remark

Installation of the transducer must be done unless otherwise specified on the datasheet, according to LEM Transducer Generic Mounting Rules. Please refer to LEM document N°ANE120504 available on our Web site: [Products/Product Documentation](#).

### HO-NP Series: name and codification

HO family products may be ordered **on request** <sup>1)</sup> with a dedicated setting of the parameters described below (standards products are delivered with the setting 0000 according to the table).

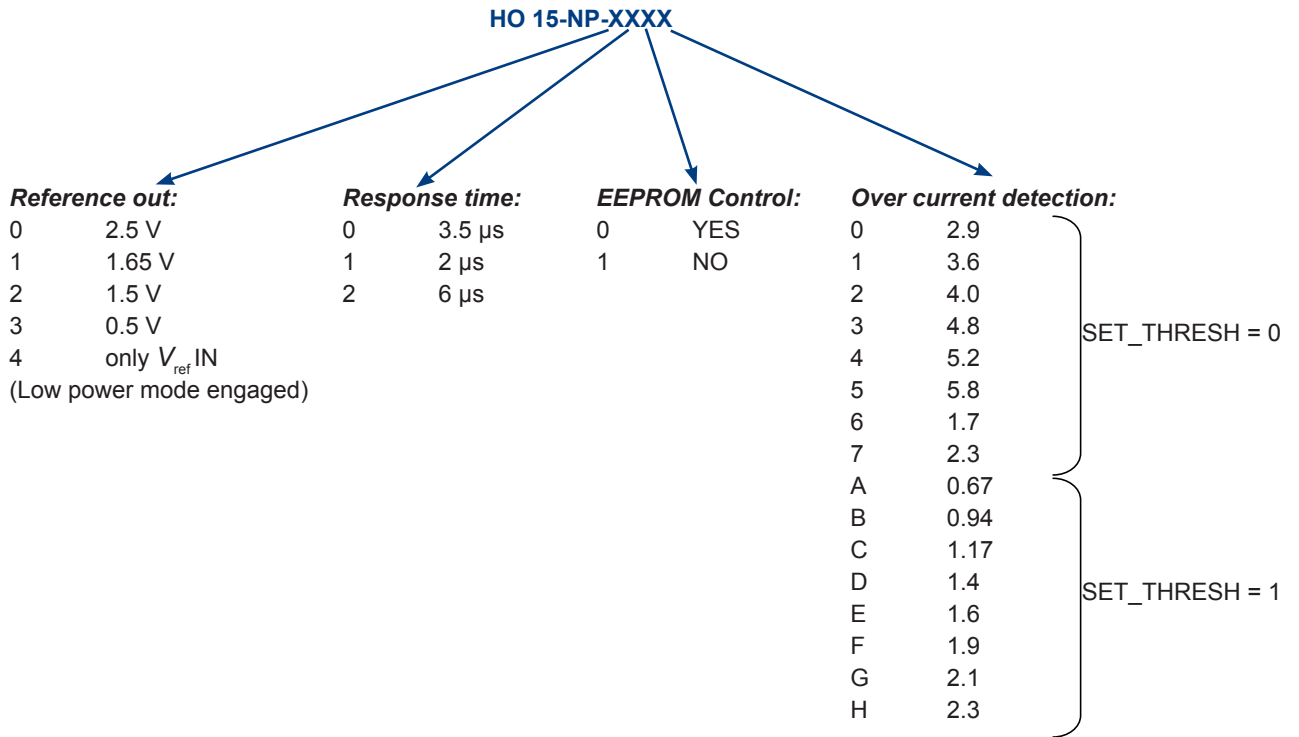

Standards products are:

- HO 8-NP-0000
- HO 15-NP-0000
- HO 25-NP-0000

Note: <sup>1)</sup> For dedicated settings, minimum quantities apply.

## PCB Footprint

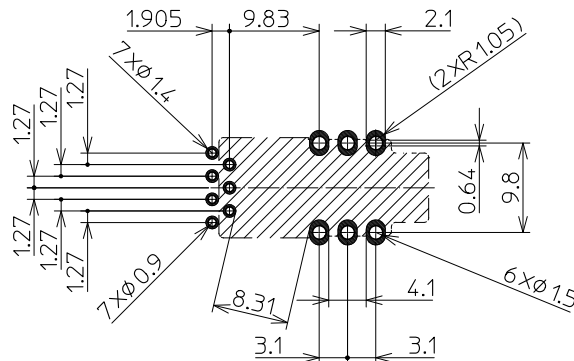

### Assembly on PCB

- Recommended PCB hole diameter  
1.5 mm for primary pin  
0.9 mm for secondary pin
- Maximum PCB thickness  
2.4 mm
- Wave soldering profile  
maximum 260 °C, 10 s  
No clean process only

### Safety

This transducer must be used in limited-energy secondary circuits according to IEC 61010-1.



This transducer must be used in electric/electronic equipment with respect to applicable standards and safety requirements in accordance with the manufacturer's operating instructions.



Caution, risk of electrical shock.

When operating the transducer, certain parts of the module can carry hazardous voltage (e.g. primary bus bar, power supply). Ignoring this warning can lead to injury and/or cause serious damage.

This transducer is a build-in device, whose conducting parts must be inaccessible after installation.

A protective housing or additional shield could be used.

Main supply must be able to be disconnected.

## Performance parameters definition

### Ampere-turns and amperes

The transducer is sensitive to the primary current linkage  $\Theta_p$  (also called ampere-turns).

$$\Theta_p = N_p \cdot I_p \text{ (At)}$$

Where  $N_p$  is the number of primary turn (depending on the connection of the primary jumpers)

Caution: As most applications will use the transducer with only one single primary turn ( $N_p = 1$ ), much of this datasheet is written in terms of primary current instead of current linkages. However, the ampere-turns (At) unit is used to emphasize that current linkages are intended and applicable.

### Transducer simplified model

The static model of the transducer at temperature  $T_A$  is:

$$V_{out} = G \cdot \Theta_p + \text{overall error (mV)}$$

In which error =

$$\varepsilon_G \cdot \Theta_p \cdot G + \varepsilon_L \cdot \Theta_p \cdot G + TCG (T_A - 25) \cdot \Theta_p \cdot G + V_{OE} + TCV_{OE} \cdot (T_A - 25) \text{ (mV)}$$

With:

- $\Theta_p = N_p \cdot I_p$  : primary current linkage (At)
- $\Theta_{Pmax}$  : max primary current linkage applied to the transducer (At)
- $V_{out}$  : output voltage (V)
- $T_A$  : ambient operating temperature ( $^{\circ}\text{C}$ )
- $V_{OE}$  : electrical offset current (V)
- $TCV_{OE}$  : temperature coefficient of  $V_{OE}$  (mV/K)
- $G$  : sensitivity of the transducer (V/At)
- $TCG$  : temperature coefficient of  $G$  (%/K)
- $\varepsilon_G$  : sensitivity error (%)
- $\varepsilon_L(\Theta_{Pmax})$  : linearity error for  $\Theta_{Pmax}$  (%)

This model is valid for primary ampere-turns  $\Theta_p$  between  $-\Theta_{Pmax}$  and  $+\Theta_{Pmax}$  only.

### Sensitivity and linearity

To measure sensitivity and linearity, the primary current (DC) is cycled from 0 to  $I_p$ , then to  $-I_p$  and back to 0 (equally spaced  $I_p/10$  steps). The sensitivity  $G$  is defined as the slope of the linear regression line for a cycle between  $\pm I_{PN}$ .

The linearity error  $\varepsilon_L$  is the maximum positive or negative difference between the measured points and the linear regression line, expressed in % of  $I_{PN}$ .

### Magnetic offset

The magnetic offset voltage  $V_{OM}$  is the consequence of a current on the primary side ("memory effect" of the transducer's ferro-magnetic parts). It is measured using the following primary current cycle.  $V_{OM}$  depends on the current value  $I_{P1}$  ( $I_{P1} > I_{PM}$ ).

$$V_{OM} = \frac{V_{out}(t_1) - V_{out}(t_2)}{2}$$

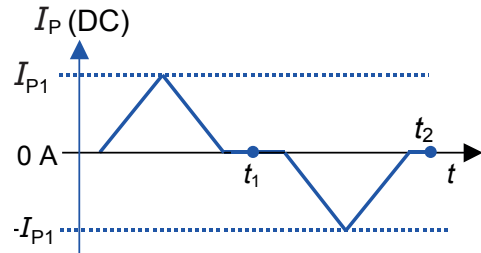

Figure 17: Current cycle used to measure magnetic and electrical offset (transducer supplied)

### Electrical offset

The electrical offset voltage  $V_{OE}$  can either be measured when the ferro-magnetic parts of the transducer are:

- completely demagnetized, which is difficult to realize,
- or in a known magnetization state, like in the current cycle shown in figure 17.

Using the current cycle shown in figure 18, the electrical

$$V_{OE} = \frac{V_{out}(t_1) + V_{out}(t_2)}{2}$$

offset is:

Note: the transducer has to be demagnetized prior to the application of the current cycle (for example with a demagnetization tunnel).

### Overall accuracy

The overall accuracy at 25  $^{\circ}\text{C}$   $X_G$  is the error in the  $-I_{PN} \dots +I_{PN}$  range, relative to the rated value  $I_{PN}$ .

It includes:

- the electrical offset  $V_{OE}/\Theta_p \cdot G$  (%)
- the sensitivity error  $\varepsilon_G$  (%)
- the linearity error  $\varepsilon_L$  (to  $I_{PN}$ ) (%)

### Response and reaction times

The response time  $t_r$  and the reaction time  $t_{ra}$  are shown in figure 18

Both depend on the primary current  $di/dt$ . They are measured at nominal ampere-turns.

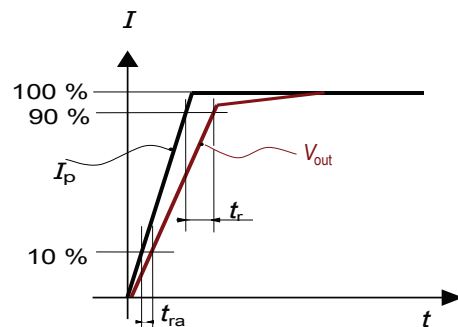
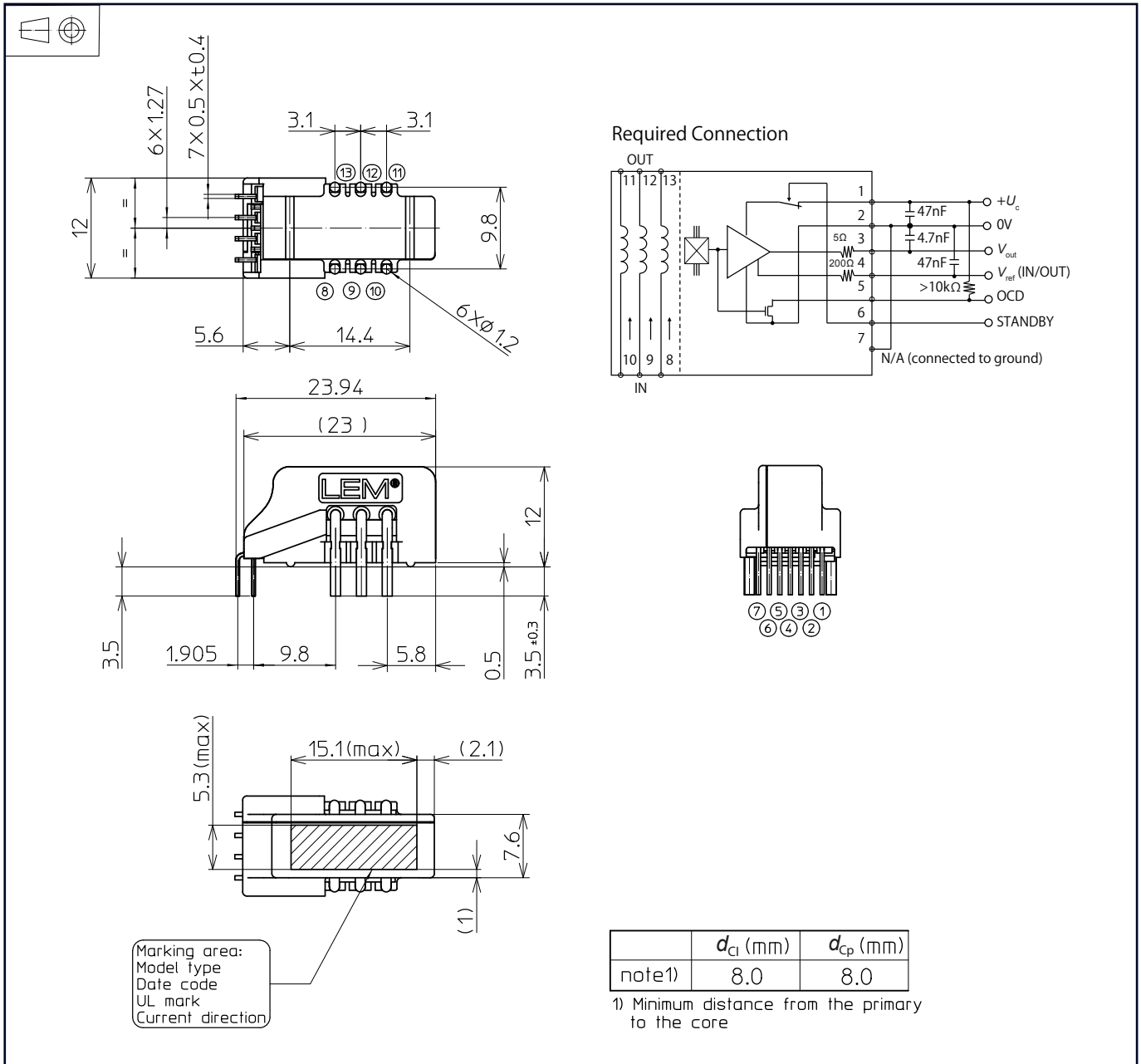

Figure 18: Response time  $t_r$  and reaction time  $t_{ra}$

## Dimensions HO 8-NP, HO 15-NP, HO 25-NP (mm, general linear tolerance $\pm 0.5$ mm)



	$d_{Cl}$ (mm)	$d_{Cp}$ (mm)
note1)	8.0	8.0

1) Minimum distance from the primary to the core