

## LM20

### 2.4V, 10µA, SC70, micro SMD Temperature Sensor

#### General Description

The LM20 is a precision analog output CMOS integrated-circuit temperature sensor that operates over a  $-55^{\circ}\text{C}$  to  $+130^{\circ}\text{C}$  temperature range. The power supply operating range is  $+2.4\text{ V}$  to  $+5.5\text{ V}$ . The transfer function of LM20 is predominately linear, yet has a slight predictable parabolic curvature. The accuracy of the LM20 when specified to a parabolic transfer function is  $\pm 1.5^{\circ}\text{C}$  at an ambient temperature of  $+30^{\circ}\text{C}$ . The temperature error increases linearly and reaches a maximum of  $\pm 2.5^{\circ}\text{C}$  at the temperature range extremes. The temperature range is affected by the power supply voltage. At a power supply voltage of  $2.7\text{ V}$  to  $5.5\text{ V}$  the temperature range extremes are  $+130^{\circ}\text{C}$  and  $-55^{\circ}\text{C}$ . Decreasing the power supply voltage to  $2.4\text{ V}$  changes the negative extreme to  $-30^{\circ}\text{C}$ , while the positive remains at  $+130^{\circ}\text{C}$ .

The LM20's quiescent current is less than  $10\text{ }\mu\text{A}$ . Therefore, self-heating is less than  $0.02^{\circ}\text{C}$  in still air. Shutdown capability for the LM20 is intrinsic because its inherent low power consumption allows it to be powered directly from the output of many logic gates or does not necessitate shutdown at all.

#### Applications

- Cellular Phones
- Computers
- Power Supply Modules

- Battery Management
- FAX Machines
- Printers
- HVAC
- Disk Drives
- Appliances

#### Features

- Rated for full  $-55^{\circ}\text{C}$  to  $+130^{\circ}\text{C}$  range
- Available in an SC70 and a micro SMD package
- Predictable curvature error
- Suitable for remote applications

#### Key Specifications

- |  |   |
|--|---|
| ■ Accuracy at $+30^{\circ}\text{C}$                          | $\pm 1.5$ to $\pm 4^{\circ}\text{C}$ (max)            |
| ■ Accuracy at $+130^{\circ}\text{C}$ & $-55^{\circ}\text{C}$ | $\pm 2.5$ to $\pm 5^{\circ}\text{C}$ (max)            |
| ■ Power Supply Voltage Range                                 | $+2.4\text{ V}$ to $+5.5\text{ V}$                    |
| ■ Current Drain  | $10\text{ }\mu\text{A}$ (max)                         |
| ■ Nonlinearity   | $\pm 0.4\%$ (typ)                                     |
| ■ Output Impedance   | $160\text{ }\Omega$ (max)                             |
| ■ Load Regulation  | $0\text{ }\mu\text{A} < I_L < +16\text{ }\mu\text{A}$ |
|  | $-2.5\text{ mV}$ (max)                                |

#### Typical Application

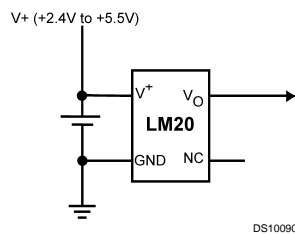

$$V_O = (-3.88 \times 10^{-6} \times T^2) + (-1.15 \times 10^{-2} \times T) + 1.8639$$

or

$$T = -1481.96 + \sqrt{2.1962 \times 10^6 + \frac{(1.8639 - V_O)}{3.88 \times 10^{-6}}}$$

where:

T is temperature, and  $V_O$  is the measured output voltage of the LM20.

Output Voltage vs Temperature

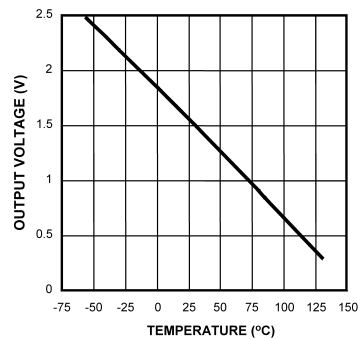

**Full-Range Celsius (Centigrade) Temperature Sensor ( $-55^{\circ}\text{C}$  to  $+130^{\circ}\text{C}$ )  
Operating from a Single Li-Ion Battery Cell**

## Typical Application (Continued)

Temperature (T)	Typical $V_O$
+130°C	+303 mV
+100°C	+675 mV
+80°C	+919 mV
+30°C	+1515 mV

Temperature (T)	Typical $V_O$
+25°C	+1574 mV
0°C	+1863.9 mV
-30°C	+2205 mV
-40°C	+2318 mV
-55°C	+2485 mV

## Connection Diagrams

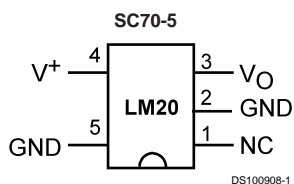

**Note:**

- GND (pin 2) may be grounded or left floating. For optimum thermal conductivity to the pc board ground plane pin 2 should be grounded.
- NC (pin 1) should be left floating or grounded. Other signal traces should not be connected to this pin.

**Top View**  
See NS Package Number MAA05A

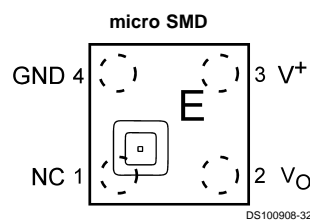

**Note:**

- Pin numbers are referenced to the package marking text orientation.
- Reference JEDEC Registration MO-211, variation BA
- The actual physical placement of package marking will vary slightly from part to part. The package marking will designate the date code and will vary considerably. Package marking does not correlate to device type in any way.

**Top View**  
See NS Package Number BPA04DDC

## Ordering Information

Order Number	Temperature Accuracy	Temperature Range	NS Package Number	Device Marking	Transport Media
LM20BIM7	±2.5°C	-55°C to +130°C	MAA05A	T2B	1000 Units on Tape and Reel
LM20BIM7X	±2.5°C	-55°C to +130°C	MAA05A	T2B	3000 Units on Tape and Reel
LM20CIM7	±5°C	-55°C to +130°C	MAA05A	T2C	1000 Units on Tape and Reel
LM20CIM7X	±5°C	-55°C to +130°C	MAA05A	T2C	3000 Units on Tape and Reel
LM20SIBP	±3.5°C	-40°C to +125°C	BPA04DDC	Date Code	250 Units on Tape and Reel
LM20SIBPX	±3.5°C	-40°C to +125°C	BPA04DDC	Date Code	3000 Units on Tape and Reel

**Absolute Maximum Ratings** (Note 1)

Supply Voltage	+6.5V to -0.2V
Output Voltage	(V <sup>+</sup> + 0.6 V) to -0.6 V
Output Current	10 mA
Input Current at any pin (Note 2)	5 mA
Storage Temperature	-65°C to +150°C
Maximum Junction Temperature (T <sub>JMAX</sub> )	+150°C
ESD Susceptibility (Note 3) :	
Human Body Model	2500 V
Machine Model	250 V

## Lead Temperature

SC-70 Package (Note 4) :

Vapor Phase (60 seconds)	+215°C
Infrared (15 seconds)	+220°C

**Operating Ratings**(Note 1)

Specified Temperature Range:	<b>T<sub>MIN</sub> ≤ T<sub>A</sub> ≤ T<sub>MAX</sub></b>
LM20B, LM20C with 2.4 V ≤ V <sup>+</sup> ≤ 2.7 V	-30°C ≤ T <sub>A</sub> ≤ +130°C
LM20B, LM20C with 2.7 V ≤ V <sup>+</sup> ≤ 5.5 V	-55°C ≤ T <sub>A</sub> ≤ +130°C
LM20S with 2.4 V ≤ V <sup>+</sup> ≤ 5.5 V	-30°C ≤ T <sub>A</sub> ≤ +125°C
LM20S with 2.7 V ≤ V <sup>+</sup> ≤ 5.5 V	-40°C ≤ T <sub>A</sub> ≤ +125°C
Supply Voltage Range (V <sup>+</sup> )	+2.4 V to +5.5 V
Thermal Resistance, θ <sub>JA</sub> (Note 5)	
SC-70	415°C/W
micro SMD	TBD°C/W

**Electrical Characteristics**

Unless otherwise noted, these specifications apply for V<sup>+</sup> = +2.7 V<sub>DC</sub>. **Boldface limits apply for T<sub>A</sub> = T<sub>J</sub> = T<sub>MIN</sub> to T<sub>MAX</sub>** ; all other limits T<sub>A</sub> = T<sub>J</sub> = 25°C; Unless otherwise noted.

Parameter	Conditions	Typical (Note 6)	LM20B	LM20C	LM20S	Units (Limit)
			Limits (Note 7)	Limits (Note 7)	Limits (Note 7)	
Temperature to Voltage Error V <sub>O</sub> = (-3.88x10 <sup>-6</sup> xT <sup>2</sup> ) + (-1.15x10 <sup>-2</sup> xT) + 1.8639V (Note 8)	T <sub>A</sub> = +25°C to +30°C		±1.5	±4.0	±2.5	°C (max)
	T <sub>A</sub> = +130°C		<b>±2.5</b>	<b>±5.0</b>		°C (max)
	T <sub>A</sub> = +125°C		<b>±2.5</b>	<b>±5.0</b>	<b>±3.5</b>	°C (max)
	T <sub>A</sub> = +100°C		<b>±2.2</b>	<b>±4.7</b>	<b>±3.2</b>	°C (max)
	T <sub>A</sub> = +85°C		<b>±2.1</b>	<b>±4.6</b>	<b>±3.1</b>	°C (max)
	T <sub>A</sub> = +80°C		<b>±2.0</b>	<b>±4.5</b>	<b>±3.0</b>	°C (max)
	T <sub>A</sub> = 0°C		<b>±1.9</b>	<b>±4.4</b>	<b>±2.9</b>	°C (max)
	T <sub>A</sub> = -30°C		<b>±2.2</b>	<b>±4.7</b>	<b>±3.3</b>	°C (min)
	T <sub>A</sub> = -40°C		<b>±2.3</b>	<b>±4.8</b>	<b>±3.5</b>	°C (max)
	T <sub>A</sub> = -55°C		<b>±2.5</b>	<b>±5.0</b>		°C (max)
Output Voltage at 0°C		+1.8639				V
Variance from Curve		±1.0				°C
Non-Linearity (Note 9)	-20°C ≤ T <sub>A</sub> ≤ +80°C	±0.4				%
Sensor Gain (Temperature Sensitivity or Average Slope) to equation: V <sub>O</sub> = -11.77 mV/°C x T + 1.860V	-30°C ≤ T <sub>A</sub> ≤ +100°C	-11.77	-11.4	-11.0	-11.0	mV/°C (min)
			-12.2	-12.6	-12.6	mV/°C (max)
Output Impedance	0 μA ≤ I <sub>L</sub> ≤ +16 μA (Notes 11, 12)		<b>160</b>	<b>160</b>	<b>160</b>	Ω (max)
Load Regulation (Note 10)	0 μA ≤ I <sub>L</sub> ≤ +16 μA (Notes 11, 12)		<b>-2.5</b>	<b>-2.5</b>	<b>-2.5</b>	mV (max)
Line Regulation	+2.4 V ≤ V <sup>+</sup> ≤ +5.0V		<b>+3.3</b>	<b>+3.7</b>	<b>+3.7</b>	mV/V (max)
	+5.0 V ≤ V <sup>+</sup> ≤ +5.5 V		<b>+8.8</b>	<b>+8.9</b>	<b>+8.9</b>	mV (max)
Quiescent Current	+2.4 V ≤ V <sup>+</sup> ≤ +5.5V	4.5	7	7	7	μA (max)
	+2.4 V ≤ V <sup>+</sup> ≤ +5.0V	4.5	<b>10</b>	<b>10</b>	<b>10</b>	μA (max)
Change of Quiescent Current	+2.4 V ≤ V <sup>+</sup> ≤ +5.5V	+0.7				μA
Temperature Coefficient of Quiescent Current		-11				nA/°C
Shutdown Current	V <sup>+</sup> ≤ +0.8 V	0.02				μA

## Electrical Characteristics (Continued)

**Note 1:** Absolute Maximum Ratings indicate limits beyond which damage to the device may occur. Operating Ratings indicate conditions for which the device is functional, but do not guarantee specific performance limits. For guaranteed specifications and test conditions, see the Electrical Characteristics. The guaranteed specifications apply only for the test conditions listed. Some performance characteristics may degrade when the device is not operated under the listed test conditions.

**Note 2:** When the input voltage ( $V_I$ ) at any pin exceeds power supplies ( $V_I < \text{GND}$  or  $V_I > V^*$ ), the current at that pin should be limited to 5 mA.

**Note 3:** The human body model is a 100 pF capacitor discharged through a 1.5 k $\Omega$  resistor into each pin. The machine model is a 200 pF capacitor discharged directly into each pin.

**Note 4:** See AN-450 "Surface Mounting Methods and Their Effect on Product Reliability" or the section titled "Surface Mount" found in any post 1986 National Semiconductor Linear Data Book for other methods of soldering surface mount devices.

**Note 5:** The junction to ambient thermal resistance ( $\theta_{JA}$ ) is specified without a heat sink in still air using the printed circuit board layout shown in *Figure "NO TARGET FOR fig NS1382"*.

**Note 6:** Typical values are at  $T_J = T_A = 25^\circ\text{C}$  and represent most likely parametric norm.

**Note 7:** Limits are guaranteed to National's AOQL (Average Outgoing Quality Level).

**Note 8:** Accuracy is defined as the error between the measured and calculated output voltage at the specified conditions of voltage, current, and temperature (expressed in  $^\circ\text{C}$ ).

**Note 9:** Non-Linearity is defined as the deviation of the calculated output-voltage-versus-temperature curve from the best-fit straight line, over the temperature range specified.

**Note 10:** Regulation is measured at constant junction temperature, using pulse testing with a low duty cycle. Changes in output due to heating effects can be computed by multiplying the internal dissipation by the thermal resistance.

**Note 11:** Negative currents are flowing into the LM20. Positive currents are flowing out of the LM20. Using this convention the LM20 can at most sink  $-1 \mu\text{A}$  and source  $+16 \mu\text{A}$ .

**Note 12:** Load regulation or output impedance specifications apply over the supply voltage range of  $+2.4\text{V}$  to  $+5.5\text{V}$ .

**Note 13:** Line regulation is calculated by subtracting the output voltage at the highest supply input voltage from the output voltage at the lowest supply input voltage.

## Typical Performance Characteristics

### Temperature Error vs Temperature

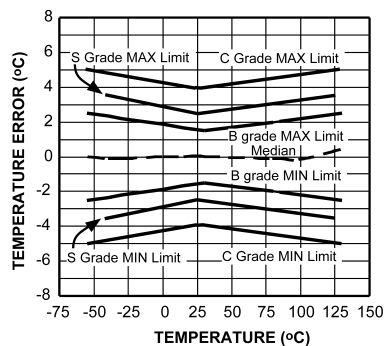

## PCB Layouts Used for Thermal Measurements

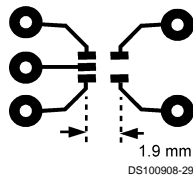

a) Layout used for no heat sink measurements.

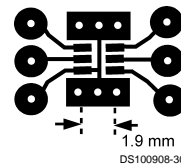

b) Layout used for measurements with small heat sink.

FIGURE 1. PCB Layouts used for thermal measurements.

## 1.0 LM20 Transfer Function

The LM20's transfer function can be described in different ways with varying levels of precision. A simple linear transfer function, with good accuracy near 25°C, is

$$V_O = -11.69 \text{ mV/}^\circ\text{C} \times T + 1.8663 \text{ V}$$

Over the full operating temperature range of -55°C to +130°C, best accuracy can be obtained by using the parabolic transfer function

$$V_O = (-3.88 \times 10^{-6} \times T^2) + (-1.15 \times 10^{-2} \times T) + 1.8639$$

solving for T:

$$T = -1481.96 + \sqrt{2.1962 \times 10^6 + \frac{(1.8639 - V_O)}{3.88 \times 10^{-6}}}$$

A linear transfer function can be used over a limited temperature range by calculating a slope and offset that give best results over that range. A linear transfer function can be calculated from the parabolic transfer function of the LM20. The slope of the linear transfer function can be calculated using the following equation:

$$m = -7.76 \times 10^{-6} \times T - 0.0115,$$

where T is the middle of the temperature range of interest and m is in V/°C. For example for the temperature range of  $T_{\min} = -30$  to  $T_{\max} = +100^\circ\text{C}$ :

$$T = 35^\circ\text{C}$$

and

$$m = -11.77 \text{ mV/}^\circ\text{C}$$

The offset of the linear transfer function can be calculated using the following equation:

$$b = (V_{OP}(T_{\max}) + V_{OP}(T) + m \times (T_{\max} + T))/2,$$

where:

- $V_{OP}(T_{\max})$  is the calculated output voltage at  $T_{\max}$  using the parabolic transfer function for  $V_O$
- $V_{OP}(T)$  is the calculated output voltage at T using the parabolic transfer function for  $V_O$ .

Using this procedure the best fit linear transfer function for many popular temperature ranges was calculated in *Figure 2*. As shown in *Figure 2* the error that is introduced by the linear transfer function increases with wider temperature ranges.

Temperature Range		Linear Equation $V_O =$	Maximum Deviation of Linear Equation from Parabolic Equation (°C)
$T_{\min}$ (°C)	$T_{\max}$ (°C)		
-55	+130	$-11.79 \text{ mV/}^\circ\text{C} \times T + 1.8528 \text{ V}$	$\pm 1.41$
-40	+110	$-11.77 \text{ mV/}^\circ\text{C} \times T + 1.8577 \text{ V}$	$\pm 0.93$
-30	+100	$-11.77 \text{ mV/}^\circ\text{C} \times T + 1.8605 \text{ V}$	$\pm 0.70$
-40	+85	$-11.67 \text{ mV/}^\circ\text{C} \times T + 1.8583 \text{ V}$	$\pm 0.65$
-10	+65	$-11.71 \text{ mV/}^\circ\text{C} \times T + 1.8641 \text{ V}$	$\pm 0.23$
+35	+45	$-11.81 \text{ mV/}^\circ\text{C} \times T + 1.8701 \text{ V}$	$\pm 0.004$
+20	+30	$-11.69 \text{ mV/}^\circ\text{C} \times T + 1.8663 \text{ V}$	$\pm 0.004$

FIGURE 2. First order equations optimized for different temperature ranges.

## 2.0 Mounting

The LM20 can be applied easily in the same way as other integrated-circuit temperature sensors. It can be glued or cemented to a surface. The temperature that the LM20 is sensing will be within about  $\pm 0.02^\circ\text{C}$  of the surface temperature to which the LM20's leads are attached to.

This presumes that the ambient air temperature is almost the same as the surface temperature; if the air temperature were much higher or lower than the surface temperature, the actual temperature measured would be at an intermediate temperature between the surface temperature and the air temperature.

To ensure good thermal conductivity the backside of the LM20 die is directly attached to the pin 2 GND pin. The temperatures of the lands and traces to the other leads of the LM20 will also affect the temperature that is being sensed.

Alternatively, the LM20 can be mounted inside a sealed-end metal tube, and can then be dipped into a bath or screwed into a threaded hole in a tank. As with any IC, the LM20 and accompanying wiring and circuits must be kept insulated and dry, to avoid leakage and corrosion. This is especially true if the circuit may operate at cold temperatures where condensation can occur. Printed-circuit coatings and varnishes such

as Humiseal and epoxy paints or dips are often used to ensure that moisture cannot corrode the LM20 or its connections.

The thermal resistance junction to ambient ( $\theta_{JA}$ ) is the parameter used to calculate the rise of a device junction temperature due to its power dissipation. For the LM20 the equation used to calculate the rise in the die temperature is as follows:

$$T_J = T_A + \theta_{JA} [(V^+ I_Q) + (V^+ - V_O) I_L]$$

where  $I_Q$  is the quiescent current and  $I_L$  is the load current on the output. Since the LM20's junction temperature is the actual temperature being measured care should be taken to minimize the load current that the LM20 is required to drive.

The tables shown in *Figure 3* summarize the rise in die temperature of the LM20 without any loading, and the thermal resistance for different conditions.

## 2.0 Mounting (Continued)

	SC70-5 no heat sink		SC70-5 small heat sink	
	$\theta_{JA}$ (°C/W)	$T_J - T_A$ (°C)	$\theta_{JA}$ (°C/W)	$T_J - T_A$ (°C)
Still air	412	0.2	350	0.19
Moving air	312	0.17	266	0.15

See Figure 1 for PCB layout samples.

	micro SMD no heat sink		micro SMD small heat fin	
	$\theta_{JA}$ (°C/W)	$T_J - T_A$ (°C)	$\theta_{JA}$ (°C/W)	$T_J - T_A$ (°C)
Still air	TBD	TBD	TBD	TBD
Moving air	TBD	TBD	TBD	TBD

FIGURE 3. Temperature Rise of LM20 Due to Self-Heating and Thermal Resistance ( $\theta_{JA}$ )

## 3.0 Capacitive Loads

The LM20 handles capacitive loading well. Without any precautions, the LM20 can drive any capacitive load less than 300 pF as shown in Figure 4. Over the specified temperature range the LM20 has a maximum output impedance of 160  $\Omega$ . In an extremely noisy environment it may be necessary to add some filtering to minimize noise pickup. It is recommended that 0.1  $\mu$ F be added from  $V^+$  to GND to bypass the power supply voltage, as shown in Figure 5. In a noisy environment it may even be necessary to add a capacitor from the output to ground with a series resistor as shown in Figure 5. A 1  $\mu$ F output capacitor with the 160  $\Omega$  maximum output impedance and a 200  $\Omega$  series resistor will form a 442 Hz lowpass filter. Since the thermal time constant of the LM20 is much slower, the overall response time of the LM20 will not be significantly affected.

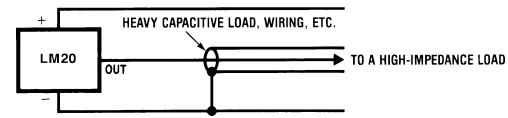

FIGURE 4. LM20 No Decoupling Required for Capacitive Loads Less than 300 pF.

R ( $\Omega$ )	C ( $\mu$ F)
200	1
470	0.1
680	0.01
1 k	0.001

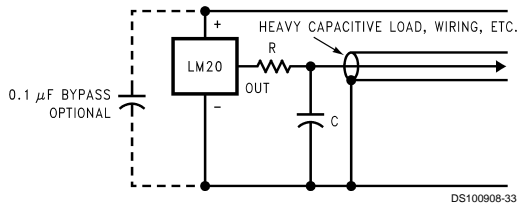
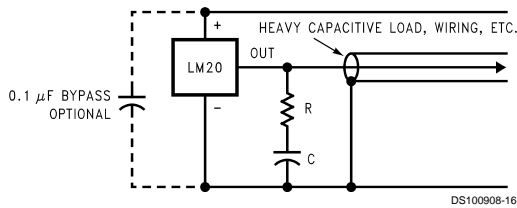

FIGURE 5. LM20 with Filter for Noisy Environment and Capacitive Loading greater than 300 pF. Either placement of resistor as shown above is just as effective.

## 4.0 LM20 micro SMD Light Sensitivity

Exposing the LM20 micro SMD package to bright sunlight may cause the output reading of the LM20 to drop by 1.5V. In a normal office environment of fluorescent lighting the output voltage is minimally affected (less than a millivolt drop). In either case it is recommended that the LM20 micro SMD be

placed inside an enclosure of some type that minimizes its light exposure. Most chassis provide more than ample protection. The LM20 does not sustain permanent damage from light exposure. Removing the light source will cause LM20's output voltage to recover to the proper value.

### 5.0 Applications Circuits

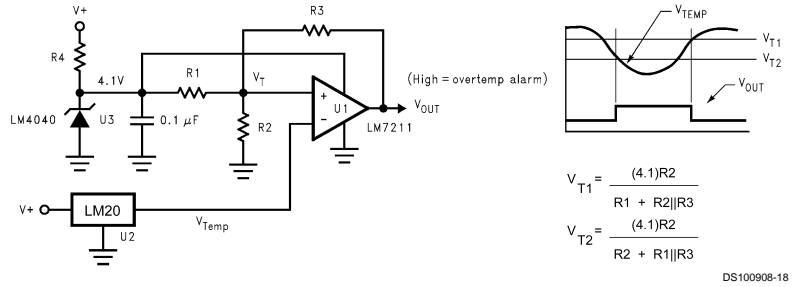

**FIGURE 6. Centigrade Thermostat**

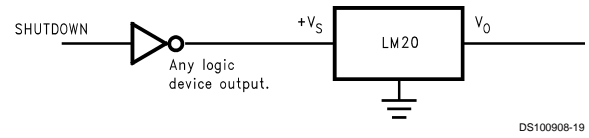

**FIGURE 7. Conserving Power Dissipation with Shutdown**

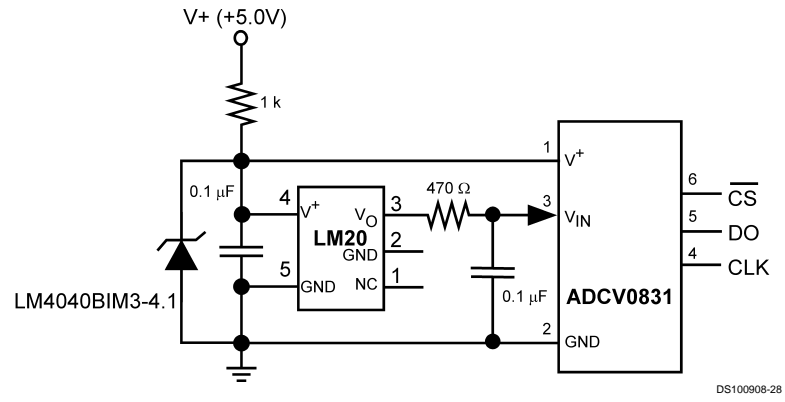

Most CMOS ADCs found in ASICs have a sampled data comparator input structure that is notorious for causing grief to analog output devices such as the LM20 and many op amps. The cause of this grief is the requirement of instantaneous charge of the input sampling capacitor in the ADC. This requirement is easily accommodated by the addition of a capacitor. Since not all ADCs have identical input stages, the charge requirements will vary necessitating a different value of compensating capacitor. This ADC is shown as an example only. If a digital output temperature is required please refer to devices such as the LM74.

**FIGURE 8. Suggested Connection to a Sampling Analog to Digital Converter Input Stage**

**Physical Dimensions** inches (millimeters) unless otherwise noted

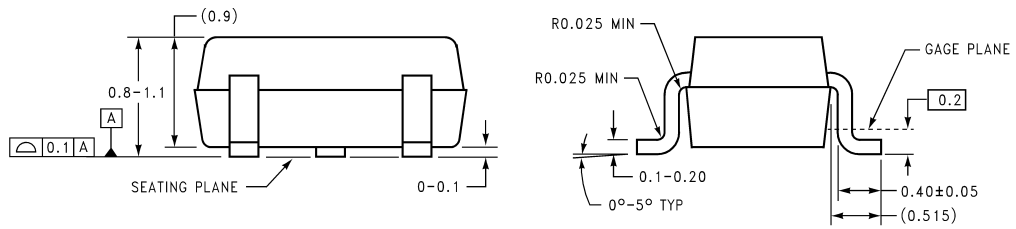
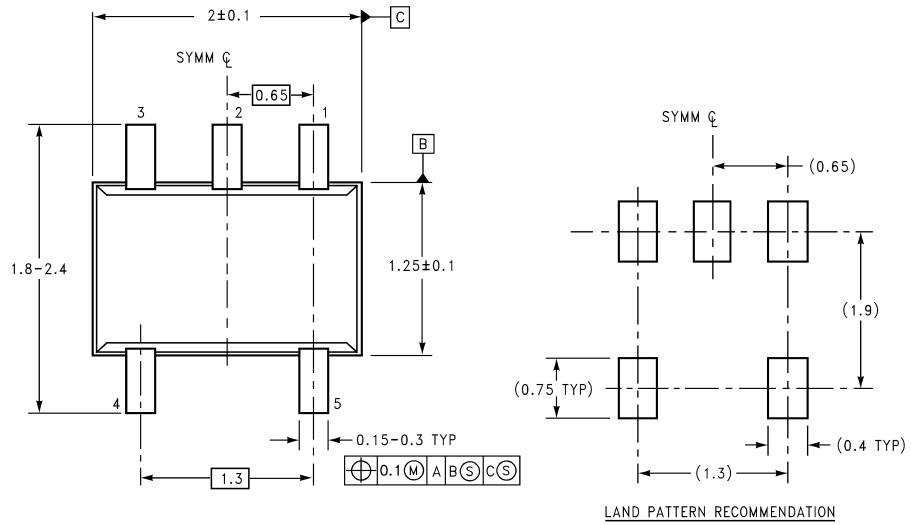

DIMENSIONS ARE IN MILLIMETERS

MAA05A (REV B)

**5-Lead SC70 Molded Package**  
**Order Number LM20BIM7 or LM20CIM7X**  
**NS Package Number MAA05A**



**Physical Dimensions** inches (millimeters) unless otherwise noted (Continued)

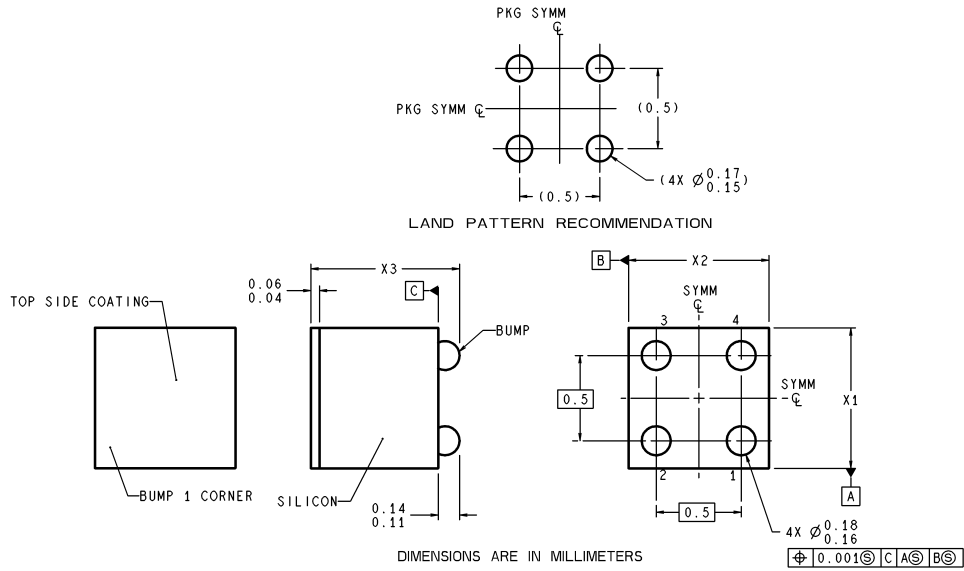

BPA04XXX (Rev A)

**4-Bump micro SMD Ball Grid Array Package**  
**Order Number LM20SIBP or LM20SIBPX**  
**NS Package Number BPA04DDC**  
**The following dimensions apply to the BPA04DDC package**  
**shown above: X1=X2 = 853µm ±30µm, X3= 900µm ±50µm**

**LIFE SUPPORT POLICY**

NATIONAL'S PRODUCTS ARE NOT AUTHORIZED FOR USE AS CRITICAL COMPONENTS IN LIFE SUPPORT DEVICES OR SYSTEMS WITHOUT THE EXPRESS WRITTEN APPROVAL OF THE PRESIDENT AND GENERAL COUNSEL OF NATIONAL SEMICONDUCTOR CORPORATION. As used herein:

1. Life support devices or systems are devices or systems which, (a) are intended for surgical implant into the body, or (b) support or sustain life, and whose failure to perform when properly used in accordance with instructions for use provided in the labeling, can be reasonably expected to result in a significant injury to the user.
2. A critical component is any component of a life support device or system whose failure to perform can be reasonably expected to cause the failure of the life support device or system, or to affect its safety or effectiveness.

<p><b>National Semiconductor Corporation</b>  Americas  Tel: 1-800-272-9959  Fax: 1-800-737-7018  Email: support@nsc.com  www.national.com</p>	<p><b>National Semiconductor Europe</b>  Fax: +49 (0) 1 80-530 85 86  Email: europe.support@nsc.com  Deutsch Tel: +49 (0) 1 80-530 85 85  English Tel: +49 (0) 1 80-532 78 32  Français Tel: +49 (0) 1 80-532 93 58  Italiano Tel: +49 (0) 1 80-534 16 80</p>	<p><b>National Semiconductor Asia Pacific Customer Response Group</b>  Tel: 65-2544466  Fax: 65-2504466  Email: sea.support@nsc.com</p>	<p><b>National Semiconductor Japan Ltd.</b>  Tel: 81-3-5639-7560  Fax: 81-3-5639-7507</p>
--	---	---	---

National does not assume any responsibility for use of any circuitry described, no circuit patent licenses are implied and National reserves the right at any time without notice to change said circuitry and specifications.