

# MOSFET

Metal Oxide Semiconductor Field Effect Transistor

## CoolMOS™ P6

600V CoolMOS™ P6 Power Transistor  
IPP60R190P6

## Data Sheet

Rev. 2.0  
Final

## 1 Description

CoolMOS™ is a revolutionary technology for high voltage power MOSFETs, designed according to the superjunction (SJ) principle and pioneered by Infineon Technologies. CoolMOS™ P6 series combines the experience of the leading SJ MOSFET supplier with high class innovation. The offered devices provide all benefits of a fast switching SJ MOSFET while not sacrificing ease of use. Extremely low switching and conduction losses make switching applications even more efficient, more compact, lighter and cooler.

### Features

- Increased MOSFET dv/dt ruggedness
- Extremely low losses due to very low FOM  $R_{DS(on)} \cdot Q_g$  and  $E_{oss}$
- Very high commutation ruggedness
- Easy to use/drive
- Pb-free plating, Halogen free mold compound
- Qualified for industrial grade applications according to JEDEC (J-STD20 and JESD22)

### Applications

PFC stages, hard switching PWM stages and resonant switching stages for e.g. PC Silverbox, Adapter, LCD & PDP TV, Lighting, Server, Telecom and UPS.

*Please note: For MOSFET paralleling the use of ferrite beads on the gate or separate totem poles is generally recommended.*

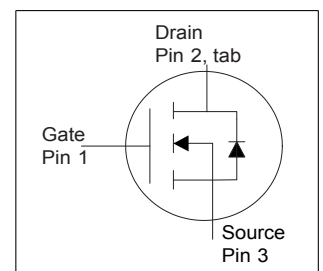
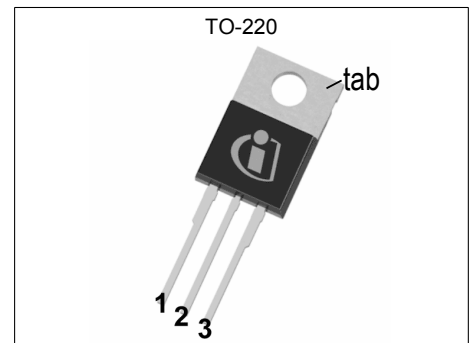

**Table 1 Key Performance Parameters**

| Parameter            | Value | Unit |
|----------------------|-------|------|
| $V_{DS} @ T_{j,max}$ | 650   | V    |
| $R_{DS(on),max}$     | 190   | mΩ   |
| $Q_{g,typ}$          | 37    | nC   |
| $I_{D,pulse}$        | 57    | A    |
| $E_{oss@400V}$       | 4.9   | μJ   |
| Body diode di/dt     | 500   | A/μs |

| Type / Ordering Code | Package   | Marking | Related Links  |
|----------------------|-----------|---------|----------------|
| IPP60R190P6          | PG-TO 220 | 6R190P6 | see Appendix A |

**Table of Contents**

|   |    |
|---|----|
| Description .....                         | 2  |
| Maximum ratings .....                     | 4  |
| Thermal characteristics .....             | 5  |
| Electrical characteristics .....          | 6  |
| Electrical characteristics diagrams ..... | 8  |
| Test Circuits .....                       | 12 |
| Package Outlines .....                    | 13 |
| Appendix A .....                          | 14 |
| Revision History .....                    | 15 |
| Disclaimer .....                          | 15 |

## 2 Maximum ratings

at  $T_j = 25^\circ\text{C}$ , unless otherwise specified

**Table 2 Maximum ratings**

| Parameter                              | Symbol        | Values |      |              | Unit             | Note / Test Condition   |
|--|---------------|--------|------|--------------|------------------|---|
|  |               | Min.   | Typ. | Max.         |                  |   |
| Continuous drain current <sup>1)</sup> | $I_D$         | -      | -    | 20.2<br>12.7 | A                | $T_C=25^\circ\text{C}$<br>$T_C=100^\circ\text{C}$                                     |
| Pulsed drain current <sup>2)</sup>     | $I_{D,pulse}$ | -      | -    | 57           | A                | $T_C=25^\circ\text{C}$  |
| Avalanche energy, single pulse         | $E_{AS}$      | -      | -    | 419          | mJ               | $I_D=3.5\text{A}$ ; $V_{DD}=50\text{V}$ ; see table 10                                |
| Avalanche energy, repetitive           | $E_{AR}$      | -      | -    | 0.63         | mJ               | $I_D=3.5\text{A}$ ; $V_{DD}=50\text{V}$ ; see table 10                                |
| Avalanche current, repetitive          | $I_{AR}$      | -      | -    | 3.5          | A                | -   |
| MOSFET dv/dt ruggedness                | dv/dt         | -      | -    | 100          | V/ns             | $V_{DS}=0\dots400\text{V}$  |
| Gate source voltage (static)           | $V_{GS}$      | -20    | -    | 20           | V                | static;   |
| Gate source voltage (dynamic)          | $V_{GS}$      | -30    | -    | 30           | V                | AC ( $f>1\text{ Hz}$ )  |
| Power dissipation                      | $P_{tot}$     | -      | -    | 151          | W                | $T_C=25^\circ\text{C}$  |
| Storage temperature                    | $T_{stg}$     | -55    | -    | 150          | $^\circ\text{C}$ | -   |
| Operating junction temperature         | $T_j$         | -55    | -    | 150          | $^\circ\text{C}$ | -   |
| Mounting torque                        | -             | -      | -    | 60           | Ncm              | M3 and M3.5 screws  |
| Continuous diode forward current       | $I_S$         | -      | -    | 17.5         | A                | $T_C=25^\circ\text{C}$  |
| Diode pulse current <sup>2)</sup>      | $I_{S,pulse}$ | -      | -    | 57           | A                | $T_C=25^\circ\text{C}$  |
| Reverse diode dv/dt <sup>3)</sup>      | dv/dt         | -      | -    | 15           | V/ns             | $V_{DS}=0\dots400\text{V}$ , $I_{SD}\leq I_S$ , $T_j=25^\circ\text{C}$<br>see table 8 |
| Maximum diode commutation speed        | di/dt         | -      | -    | 500          | A/ $\mu\text{s}$ | $V_{DS}=0\dots400\text{V}$ , $I_{SD}\leq I_S$ , $T_j=25^\circ\text{C}$<br>see table 8 |
| Insulation withstand voltage           | $V_{ISO}$     | -      | -    | n.a.         | V                | $V_{rms}$ , $T_C=25^\circ\text{C}$ , $t=1\text{min}$                                  |

<sup>1)</sup> Limited by  $T_{j,max}$ . Maximum duty cycle  $D=0.75$

<sup>2)</sup> Pulse width  $t_p$  limited by  $T_{j,max}$

<sup>3)</sup> Identical low side and high side switch with identical  $R_G$

### 3 Thermal characteristics

**Table 3 Thermal characteristics**

| Parameter  | Symbol     | Values |      |      | Unit | Note / Test Condition               |
|--|------------|--------|------|------|------|-------------------------------------|
|  |            | Min.   | Typ. | Max. |      |                                     |
| Thermal resistance, junction - case                        | $R_{thJC}$ | -      | -    | 0.83 | °C/W | -                                   |
| Thermal resistance, junction - ambient                     | $R_{thJA}$ | -      | -    | 62   | °C/W | leaded                              |
| Thermal resistance, junction - ambient for SMD version     | $R_{thJA}$ | -      | -    | -    | °C/W | n.a.                                |
| Soldering temperature, wavesoldering only allowed at leads | $T_{sold}$ | -      | -    | 260  | °C   | 1.6mm (0.063 in.) from case for 10s |

## 4 Electrical characteristics

at  $T_j=25^\circ\text{C}$ , unless otherwise specified

**Table 4 Static characteristics**

| Parameter                        | Symbol        | Values |                |            | Unit          | Note / Test Condition   |
|----------------------------------|---------------|--------|----------------|------------|---------------|---|
|                                  |               | Min.   | Typ.           | Max.       |               |   |
| Drain-source breakdown voltage   | $V_{(BR)DSS}$ | 600    | -              | -          | V             | $V_{GS}=0\text{V}$ , $I_D=1\text{mA}$   |
| Gate threshold voltage           | $V_{(GS)th}$  | 3.5    | 4.0            | 4.5        | V             | $V_{DS}=V_{GS}$ , $I_D=0.63\text{mA}$   |
| Zero gate voltage drain current  | $I_{DSS}$     | -      | -              | 1          | $\mu\text{A}$ | $V_{DS}=600$ , $V_{GS}=0\text{V}$ , $T_j=25^\circ\text{C}$<br>$V_{DS}=600$ , $V_{GS}=0\text{V}$ , $T_j=150^\circ\text{C}$             |
| Gate-source leakage current      | $I_{GSS}$     | -      | -              | 100        | nA            | $V_{GS}=20\text{V}$ , $V_{DS}=0\text{V}$  |
| Drain-source on-state resistance | $R_{DS(on)}$  | -      | 0.171<br>0.445 | 0.190<br>- | $\Omega$      | $V_{GS}=10\text{V}$ , $I_D=7.6\text{A}$ , $T_j=25^\circ\text{C}$<br>$V_{GS}=10\text{V}$ , $I_D=7.6\text{A}$ , $T_j=150^\circ\text{C}$ |
| Gate resistance                  | $R_G$         | -      | 3.4            | -          | $\Omega$      | $f=1\text{MHz}$ , open drain  |

**Table 5 Dynamic characteristics**

| Parameter  | Symbol       | Values |      |      | Unit | Note / Test Condition   |
|--|--------------|--------|------|------|------|---|
|  |              | Min.   | Typ. | Max. |      |   |
| Input capacitance  | $C_{iss}$    | -      | 1750 | -    | pF   | $V_{GS}=0\text{V}$ , $V_{DS}=100\text{V}$ , $f=1\text{MHz}$                                       |
| Output capacitance   | $C_{oss}$    | -      | 76   | -    | pF   | $V_{GS}=0\text{V}$ , $V_{DS}=100\text{V}$ , $f=1\text{MHz}$                                       |
| Effective output capacitance, energy related <sup>1)</sup> | $C_{o(er)}$  | -      | 61   | -    | pF   | $V_{GS}=0\text{V}$ , $V_{DS}=0\dots400\text{V}$   |
| Effective output capacitance, time related <sup>2)</sup>   | $C_{o(tr)}$  | -      | 264  | -    | pF   | $I_D=\text{constant}$ , $V_{GS}=0\text{V}$ , $V_{DS}=0\dots400\text{V}$                           |
| Turn-on delay time   | $t_{d(on)}$  | -      | 15   | -    | ns   | $V_{DD}=400\text{V}$ , $V_{GS}=13\text{V}$ , $I_D=9.5\text{A}$ ,<br>$R_G=3.4\Omega$ ; see table 9 |
| Rise time  | $t_r$        | -      | 8    | -    | ns   | $V_{DD}=400\text{V}$ , $V_{GS}=13\text{V}$ , $I_D=9.5\text{A}$ ,<br>$R_G=3.4\Omega$ ; see table 9 |
| Turn-off delay time  | $t_{d(off)}$ | -      | 45   | -    | ns   | $V_{DD}=400\text{V}$ , $V_{GS}=13\text{V}$ , $I_D=9.5\text{A}$ ,<br>$R_G=3.4\Omega$ ; see table 9 |
| Fall time  | $t_f$        | -      | 7    | -    | ns   | $V_{DD}=400\text{V}$ , $V_{GS}=13\text{V}$ , $I_D=9.5\text{A}$ ,<br>$R_G=3.4\Omega$ ; see table 9 |

**Table 6 Gate charge characteristics**

| Parameter             | Symbol        | Values |      |      | Unit | Note / Test Condition   |
|-----------------------|---------------|--------|------|------|------|---|
|                       |               | Min.   | Typ. | Max. |      |   |
| Gate to source charge | $Q_{gs}$      | -      | 11   | -    | nC   | $V_{DD}=400\text{V}$ , $I_D=9.5\text{A}$ , $V_{GS}=0$ to $10\text{V}$ |
| Gate to drain charge  | $Q_{gd}$      | -      | 13   | -    | nC   | $V_{DD}=400\text{V}$ , $I_D=9.5\text{A}$ , $V_{GS}=0$ to $10\text{V}$ |
| Gate charge total     | $Q_g$         | -      | 37   | -    | nC   | $V_{DD}=400\text{V}$ , $I_D=9.5\text{A}$ , $V_{GS}=0$ to $10\text{V}$ |
| Gate plateau voltage  | $V_{plateau}$ | -      | 6.1  | -    | V    | $V_{DD}=400\text{V}$ , $I_D=9.5\text{A}$ , $V_{GS}=0$ to $10\text{V}$ |

<sup>1)</sup>  $C_{o(er)}$  is a fixed capacitance that gives the same stored energy as  $C_{oss}$  while  $V_{DS}$  is rising from 0 to 400V

<sup>2)</sup>  $C_{o(tr)}$  is a fixed capacitance that gives the same charging time as  $C_{oss}$  while  $V_{DS}$  is rising from 0 to 400V

**Table 7 Reverse diode characteristics**

| Parameter                     | Symbol    | Values |      |      | Unit    | Note / Test Condition                                  |
|-------------------------------|-----------|--------|------|------|---------|--|
|                               |           | Min.   | Typ. | Max. |         |  |
| Diode forward voltage         | $V_{SD}$  | -      | 0.9  | -    | V       | $V_{GS}=0V, I_F=9.5A, T_j=25^{\circ}C$                 |
| Reverse recovery time         | $t_{rr}$  | -      | 310  | -    | ns      | $V_R=400V, I_F=9.5A, di_F/dt=100A/\mu s$ ; see table 8 |
| Reverse recovery charge       | $Q_{rr}$  | -      | 4    | -    | $\mu C$ | $V_R=400V, I_F=9.5A, di_F/dt=100A/\mu s$ ; see table 8 |
| Peak reverse recovery current | $I_{rrm}$ | -      | 25   | -    | A       | $V_R=400V, I_F=9.5A, di_F/dt=100A/\mu s$ ; see table 8 |

### 5 Electrical characteristics diagrams

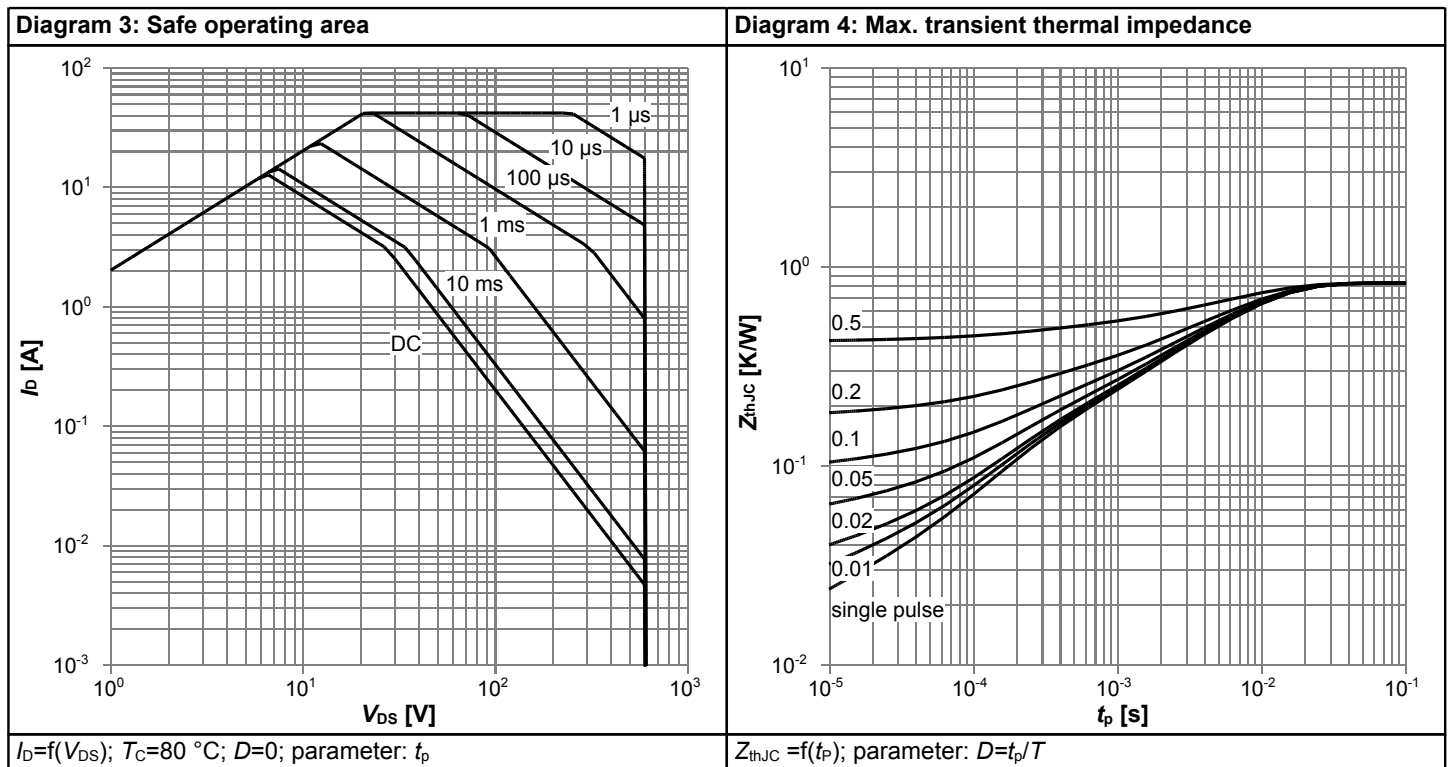
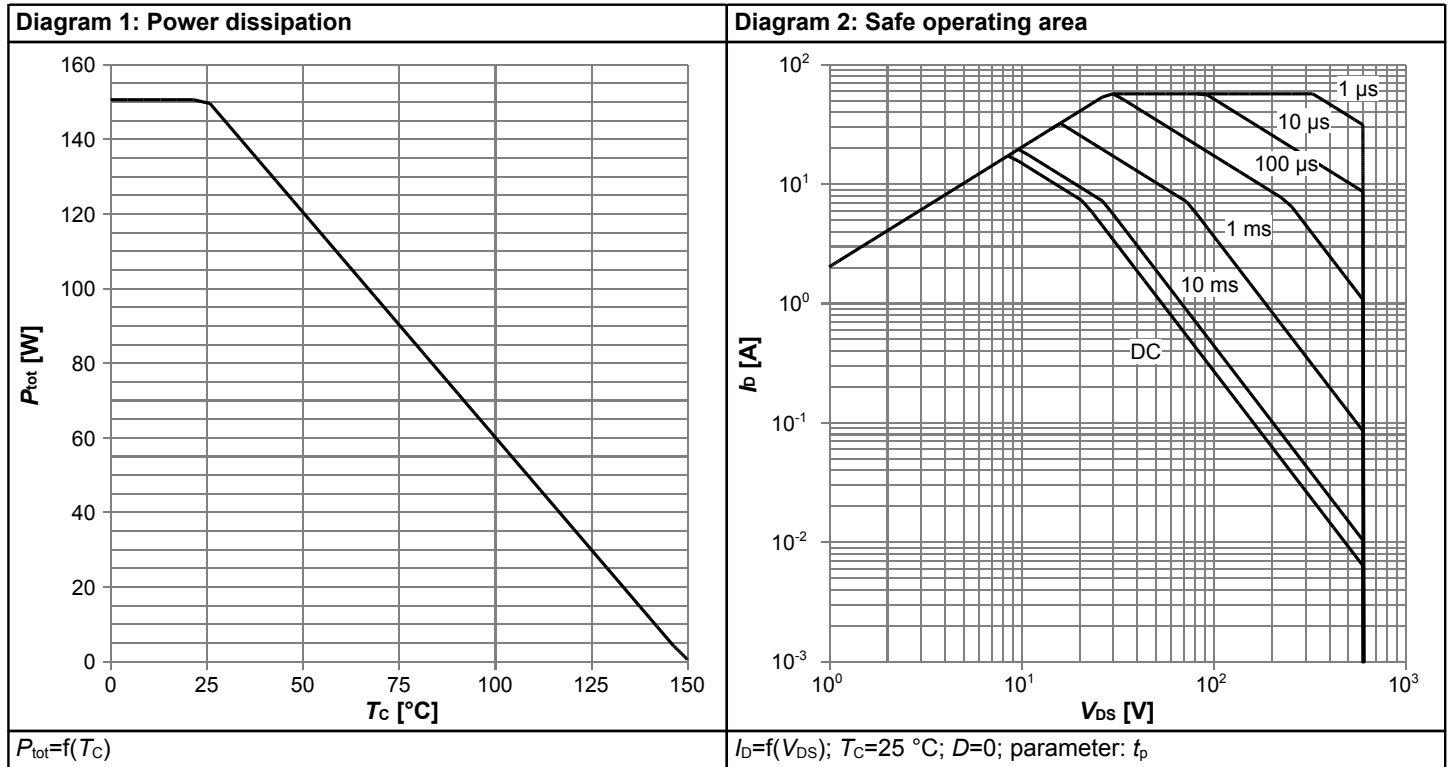
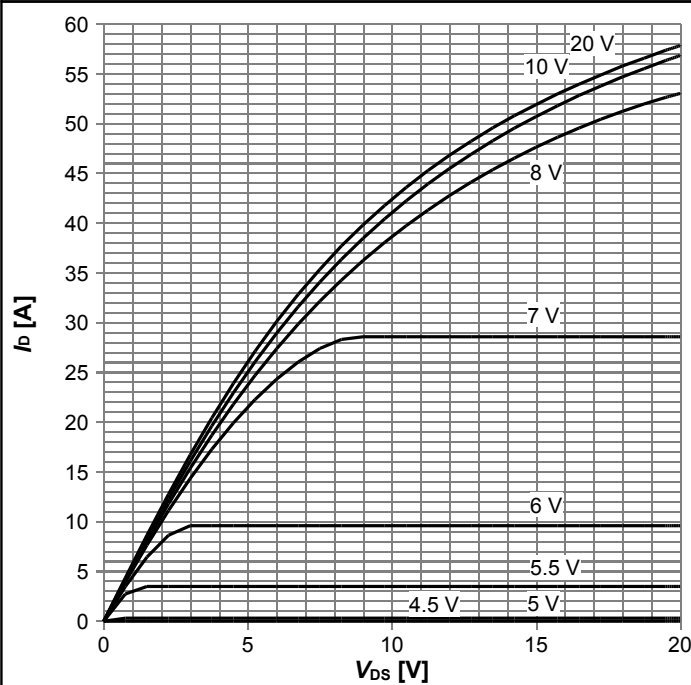

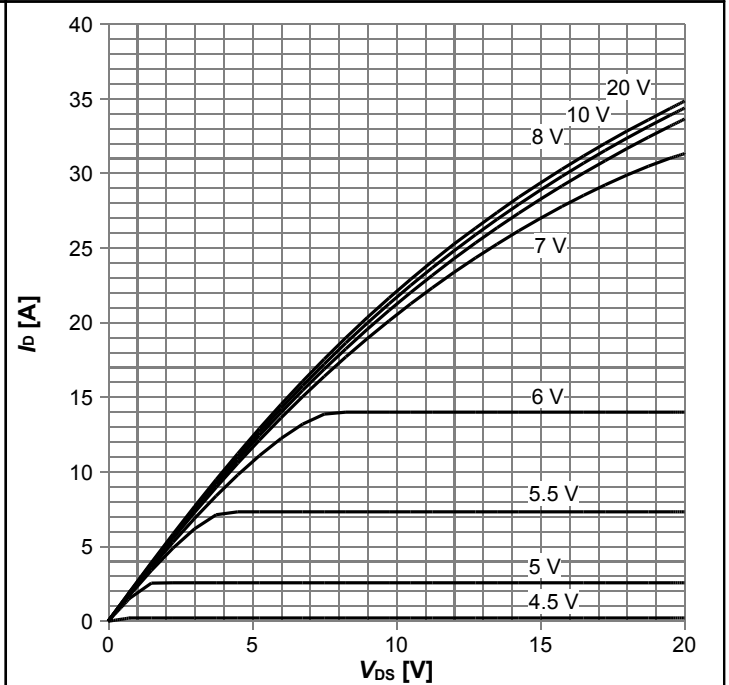

Diagram 5: Typ. output characteristics



$I_D=f(V_{DS}); T_j=25\text{ °C};$  parameter:  $V_{GS}$

Diagram 6: Typ. output characteristics



$I_D=f(V_{DS}); T_j=125\text{ °C};$  parameter:  $V_{GS}$

Diagram 7: Typ. drain-source on-state resistance

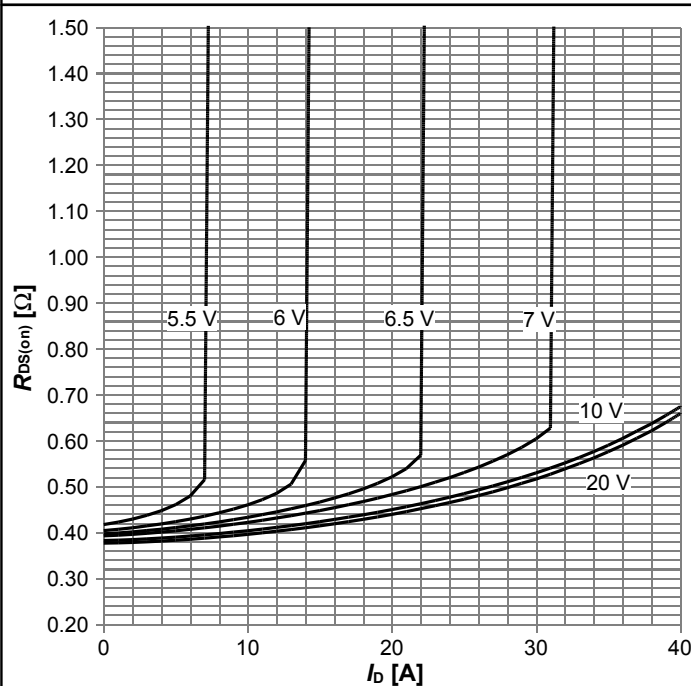

$R_{DS(on)}=f(I_D); T_j=125\text{ °C};$  parameter:  $V_{GS}$

Diagram 8: Drain-source on-state resistance

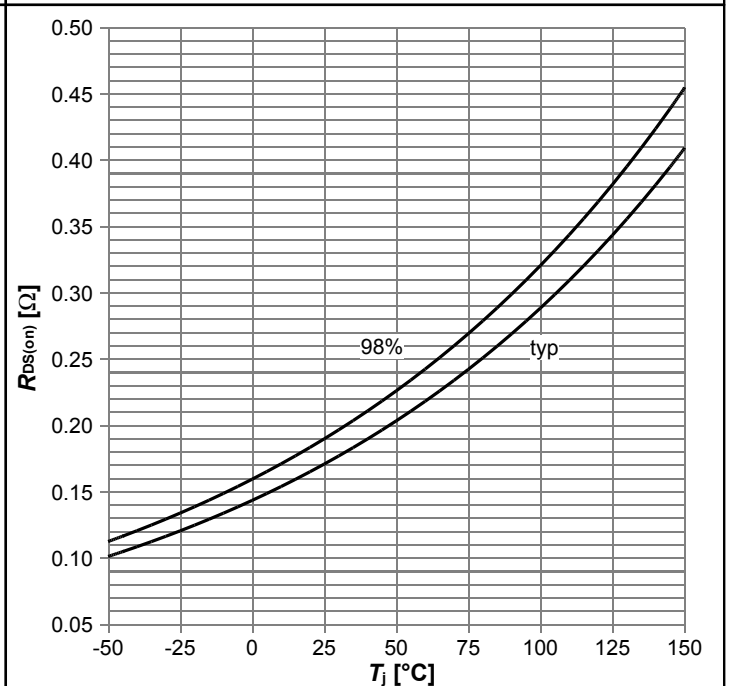

$R_{DS(on)}=f(T_j); I_D=7.6\text{ A}; V_{GS}=10\text{ V}$

Diagram 9: Typ. transfer characteristics

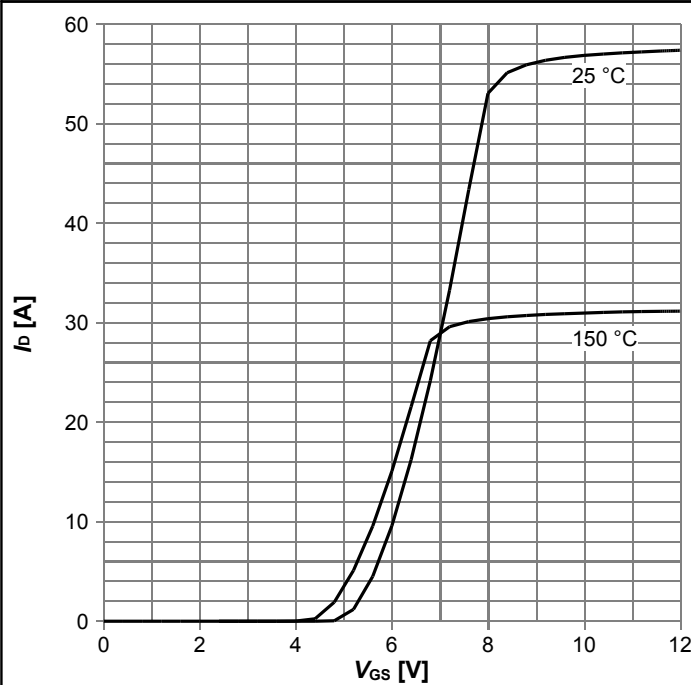

$I_D=f(V_{GS}); V_{DS}=20V; \text{parameter: } T_j$

Diagram 10: Typ. gate charge

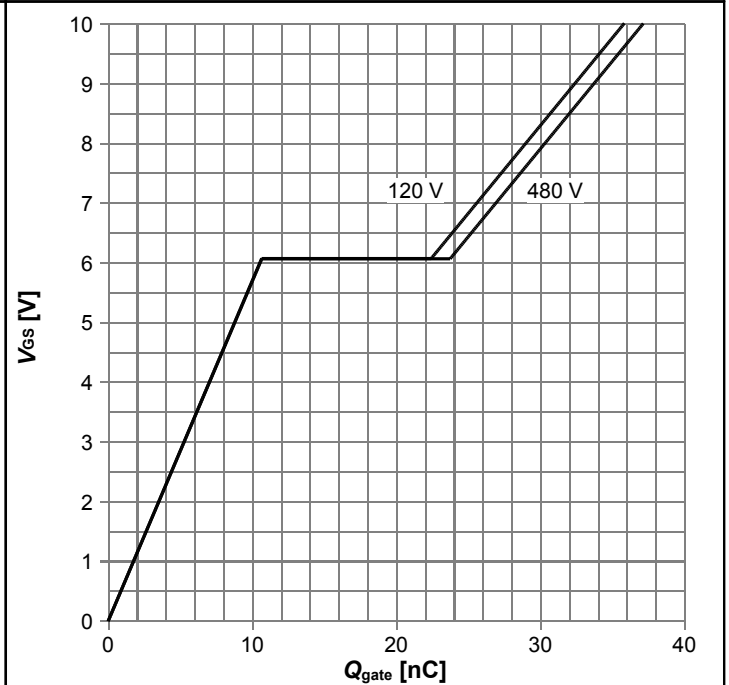

$V_{GS}=f(Q_{gate}); I_D=9.5 \text{ A pulsed}; \text{parameter: } V_{DD}$

Diagram 11: Forward characteristics of reverse diode

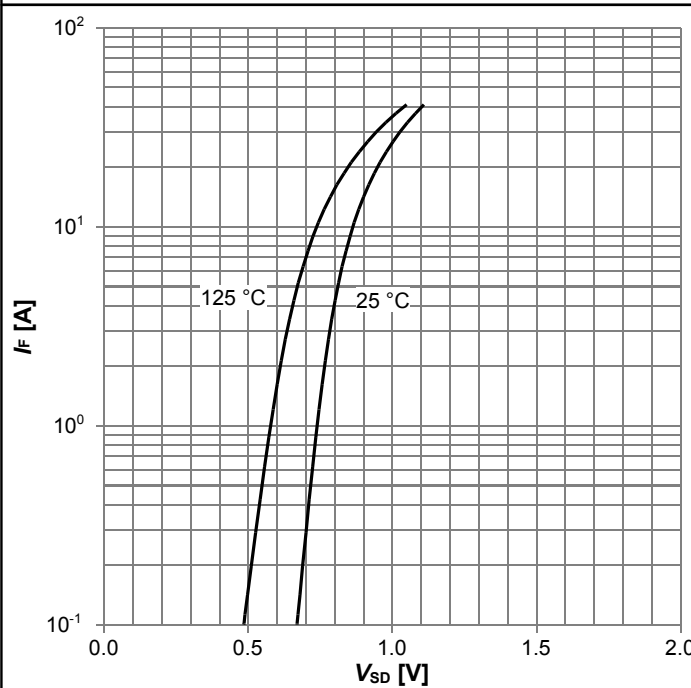

$I_F=f(V_{SD}); \text{parameter: } T_j$

Diagram 12: Avalanche energy

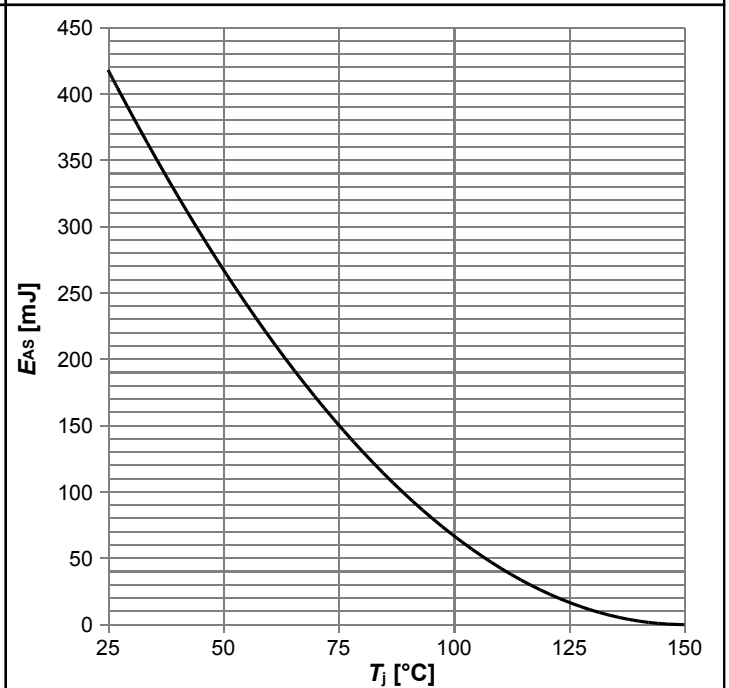

$E_{AS}=f(T_j); I_D=3.5 \text{ A}; V_{DD}=50 \text{ V}$

Diagram 13: Drain-source breakdown voltage

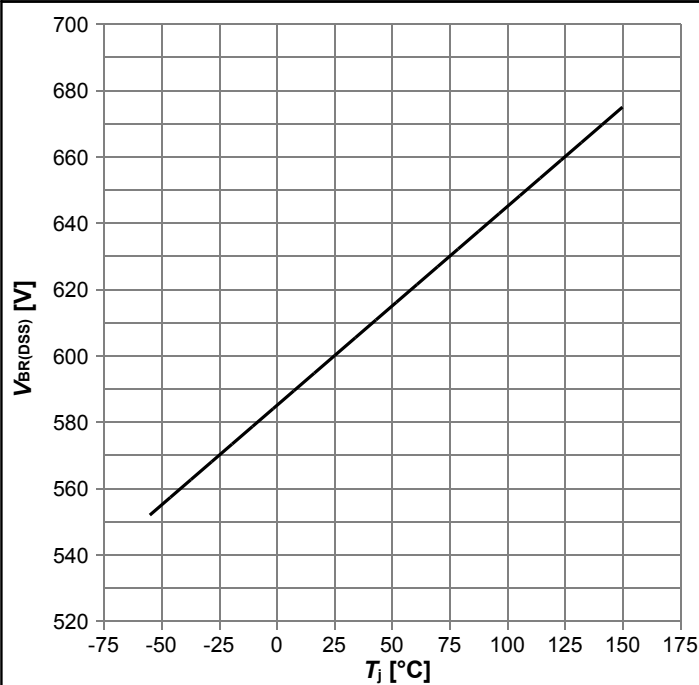

$V_{BR(DSS)}=f(T_j); I_D=1 \text{ mA}$

Diagram 14: Typ. capacitances

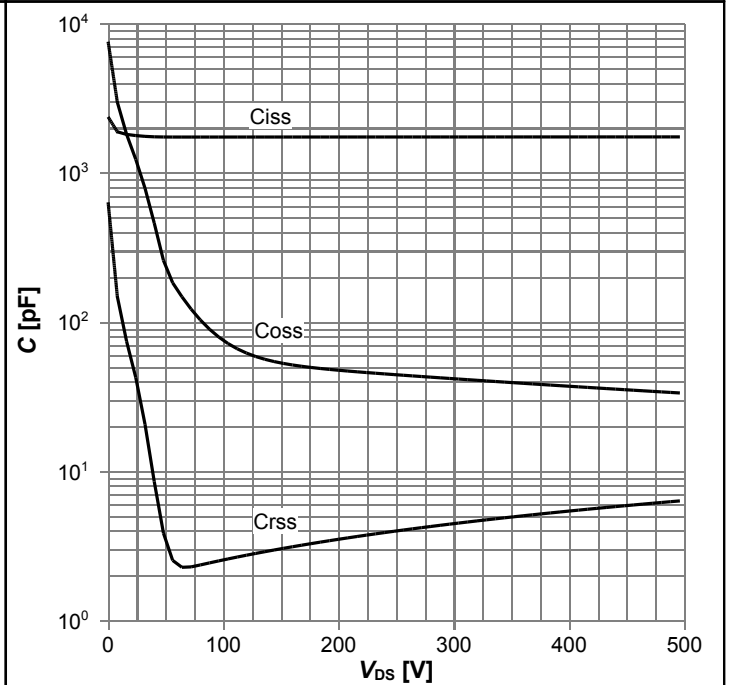

$C=f(V_{DS}); V_{GS}=0 \text{ V}; f=1 \text{ MHz}$

Diagram 15: Typ. Coss stored energy

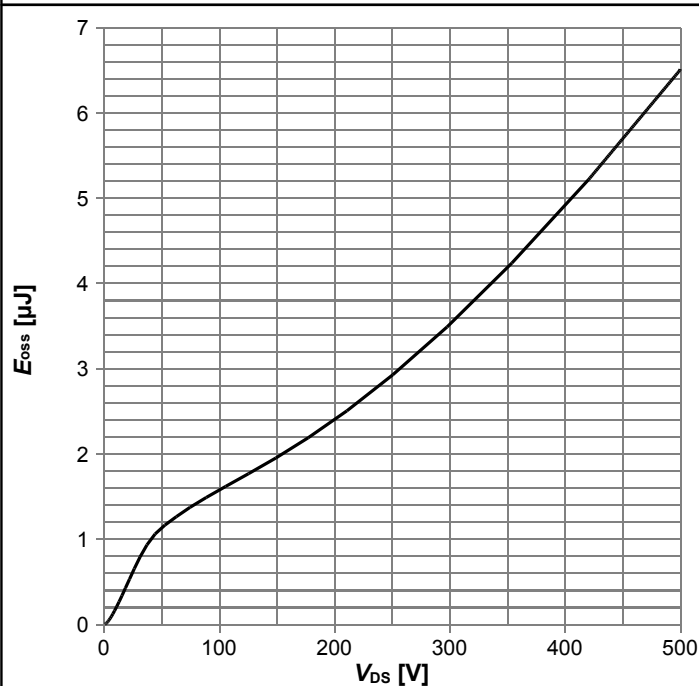

$E_{oss}=f(V_{DS})$

## 6 Test Circuits

**Table 8 Diode characteristics**

| Test circuit for diode characteristics | Diode recovery waveform |
|--|-------------------------|
|  |                         |

**Table 9 Switching times**

| Switching times test circuit for inductive load | Switching times waveform |
|---|--------------------------|
|   |                          |

**Table 10 Unclamped inductive load**

| Unclamped inductive load test circuit | Unclamped inductive waveform |
|---------------------------------------|------------------------------|
|                                       |                              |

## 7 Package Outlines

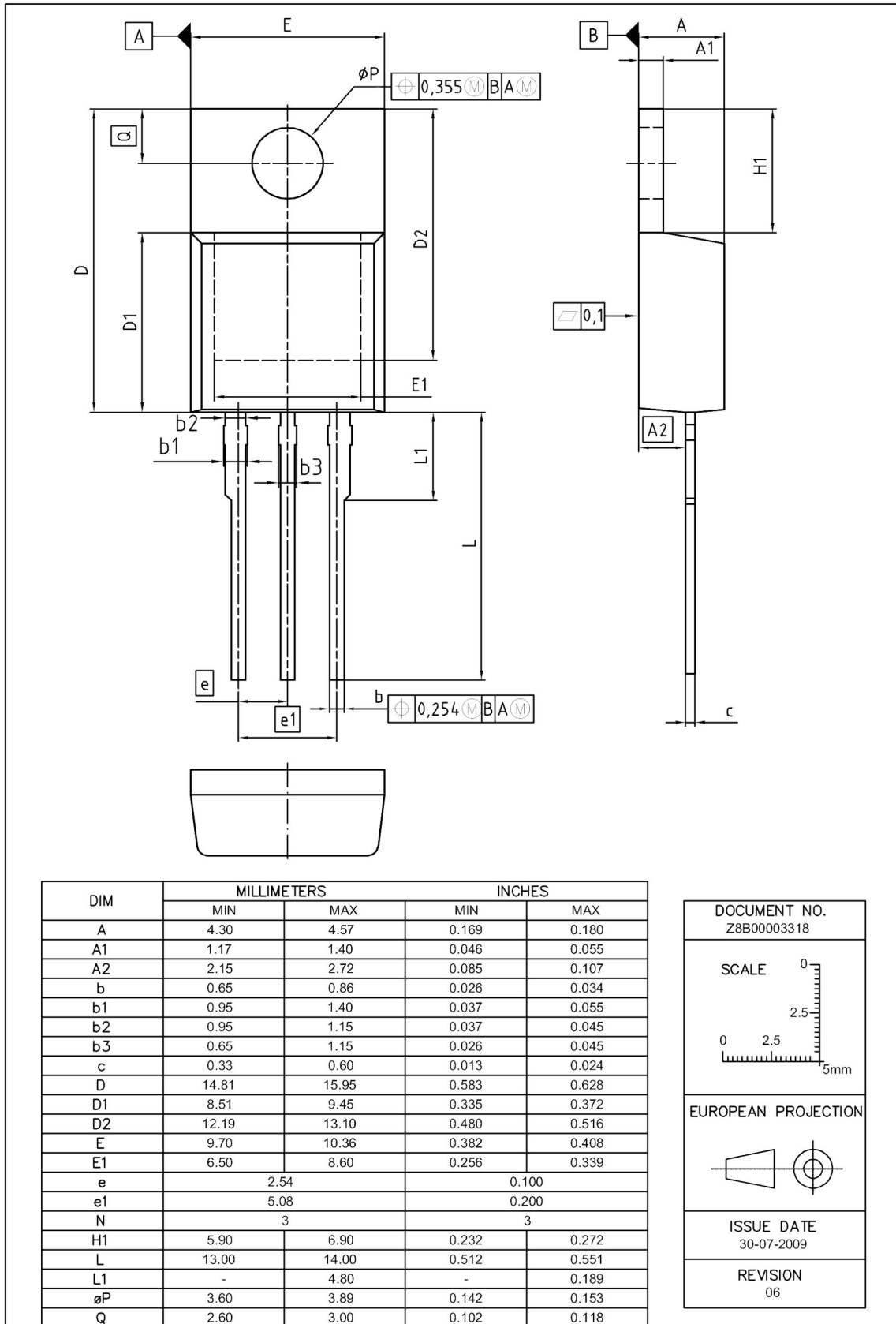

Figure 1 Outline PG-TO 220, dimensions in mm/inches

## 8 Appendix A

### Table 11 Related Links

- IFX CoolMOS™ P6 Webpage: [www.infineon.com](http://www.infineon.com)
- IFX CoolMOS™ P6 application note: [www.infineon.com](http://www.infineon.com)
- IFX CoolMOS™ P6 simulation model: [www.infineon.com](http://www.infineon.com)
- IFX Design tools: [www.infineon.com](http://www.infineon.com)

## Revision History

IPP60R190P6

**Revision: 2013-06-07, Rev. 2.0**

Previous Revision

| Revision | Date       | Subjects (major changes since last revision) |
|----------|------------|--|
| 2.0      | 2013-06-07 | Release of final version                     |

### We Listen to Your Comments

Any information within this document that you feel is wrong, unclear or missing at all? Your feedback will help us to continuously improve the quality of this document. Please send your proposal (including a reference to this document) to:

[erratum@infineon.com](mailto:erratum@infineon.com)

### Edition 2011-08-01

Published by

Infineon Technologies AG

81726 München, Germany

© 2011 Infineon Technologies AG

All Rights Reserved.

### Legal Disclaimer

The information given in this document shall in no event be regarded as a guarantee of conditions or characteristics. With respect to any examples or hints given herein, any typical values stated herein and/or any information regarding the application of the device, Infineon Technologies hereby disclaims any and all warranties and liabilities of any kind, including without limitation, warranties of non-infringement of intellectual property rights of any third party.

### Information

For further information on technology, delivery terms and conditions and prices please contact your nearest Infineon Technologies Office ([www.infineon.com](http://www.infineon.com)).

### Warnings

Due to technical requirements, components may contain dangerous substances. For information on the types in question, please contact the nearest Infineon Technologies Office.

The Infineon Technologies component described in this Data Sheet may be used in life-support devices or systems and/or automotive, aviation and aerospace applications or systems only with the express written approval of Infineon Technologies, if a failure of such components can reasonably be expected to cause the failure of that life-support, automotive, aviation and aerospace device or system or to affect the safety or effectiveness of that device or system. Life support devices or systems are intended to be implanted in the human body or to support and/or maintain and sustain and/or protect human life. If they fail, it is reasonable to assume that the health of the user or other persons may be endangered.