Design Example Report

Title	<i>Low Line Only Low Profile T8, Isolated 23 W, Power Factor Corrected (PF >0.98), LED Driver Using LYTSwitch™ LYT4215E</i>
Specification	90 VAC – 135 VAC Input; 50 V, 430 mA Output
Application	LED Driver for Low Profile T8
Author	Applications Engineering Department
Document Number	DER-338
Date	January 29 2013
Revision	1.0

Summary and Features

- Low cost
 - Combines PFC and PSR controlled CC into a single stage
 - Single sided PCB
 - Low component count
- Low profile (less than 10 mm component height)
- Highly energy efficient
 - ≥86% at 110 VAC
- PF >0.98, THD <15% at 110 VAC
- Surge resistant
 - Meets 1 kV differential surge protection
 - Meets 500 V surge without MOV
 - IEC 61000-4-5 ring wave
- Integrated protection and reliability features
 - Output open circuit / output short-circuit protected with auto-recovery
 - Line input overvoltage shutdown extends voltage withstand during line faults
 - Auto-recovering thermal shutdown with large hysteresis protects both components and printed circuit board

Power Integrations

5245 Hellyer Avenue, San Jose, CA 95138 USA.

Tel: +1 408 414 9200 Fax: +1 408 414 9201

www.powerint.com

PATENT INFORMATION

The products and applications illustrated herein (including transformer construction and circuits external to the products) may be covered by one or more U.S. and foreign patents, or potentially by pending U.S. and foreign patent applications assigned to Power Integrations. A complete list of Power Integrations' patents may be found at www.powerint.com. Power Integrations grants its customers a license under certain patent rights as set forth at <http://www.powerint.com/ip.htm>.



Table of Contents

1	Introduction	5
2	Power Supply Specification	6
3	Schematic	7
4	Circuit Description	8
4.1	Input Filtering	8
4.2	LYTSwitch Primary	8
4.3	Feedback	9
4.4	Output Rectification	9
5	PCB Layout	10
6	Bill of Materials	11
7	Common Mode Inductor Specification	12
7.1	Electrical Specifications	12
7.2	Materials	12
7.3	Winding Instructions	12
8	Transformer Specification	13
8.1	Electrical Diagram	13
8.2	Electrical Specifications	13
8.3	Materials	13
8.4	Transformer Build Diagram	14
8.5	Transformer Construction	14
9	Transformer Design Spreadsheet	15
10	Heat Sink Assembly	17
10.1	Heat Sink Fabrication Drawing	17
10.2	Heat Sink Assembly Drawing	18
10.3	Heat Sink and LYTSwitch Assembly Drawing	19
11	Performance Data	20
11.1	Efficiency	20
11.2	Line and Load Regulation	21
11.3	Power Factor	22
11.4	A-THD	23
11.5	Harmonic Currents	24
11.5.1	45 V LED Load	24
11.5.2	50 V LED Load	25
11.5.3	55 V LED Load	26
11.6	Test Data	27
11.6.1	Test Data, 45 V LED Load	27
11.6.2	Test Data, 50 V LED Load	27
11.6.3	Test Data, 55 V LED Load	27
11.6.4	115 VAC 60 Hz, 45 V LED Load Harmonics Data	28
11.6.5	115 VAC 60 Hz, 50 V LED Load Harmonics Data	29
11.6.6	115 VAC 60 Hz, 55 V LED Load Harmonics Data	30
12	Thermal Performance	31
12.1	$V_{IN} = 115 \text{ VAC}$, 60 Hz, 50 V LED Load	31
13	Waveforms	32



13.1	Input Voltage and Input Current Waveforms	32
13.2	Output Voltage and Output Current Waveforms	33
13.3	Output Voltage and Output Current Waveforms at Start-up	34
13.4	Drain Voltage and Current Waveforms at Start-up	34
13.5	Input Voltage and Output Current Waveforms at Start-up	35
13.6	Drain Voltage and Current Waveforms	36
13.7	Output Short Condition	37
13.8	Output Diode Voltage and Current Waveforms	38
13.9	Output Voltage Waveforms at Open Load	38
14	Conducted EMI	39
15	Line Surge	40
16	Revision History	41

Important Note: Although this board is designed to satisfy safety isolation requirements, the engineering prototype has not been agency approved. Therefore, all testing should be performed using an isolation transformer to provide the AC input to the prototype board.



1 Introduction

The document describes a low profile T8 (<10 mm component height), isolated, high power factor (PF) LED driver designed to drive a nominal LED string voltage of 50 V at 430 mA from an input voltage range of 90 VAC to 135 VAC. The LED driver utilizes the LYT4215E from the LYTSwitch family of ICs.

Key goals for this design were:

- Fit into narrow (<20 mm), component height (<10 mm) T8 lamp enclosure
- Pass 1 kV differential surge

The topology is a single-stage, power factor corrected continuous conduction mode flyback that meets high efficiency, high power factor, low THD, isolation, low component count, and meets stringent space requirements.

High power factor and low THD is achieved by employing the LYTSwitch IC which also provides a sophisticated range of protection features including auto-restart for open control loop and output short-circuit conditions.

This document contains the LED driver specification, schematic, PCB diagram, bill of materials, transformer documentation and typical performance characteristics.



Figure 1 – Populated Circuit Board Photograph (Top View).

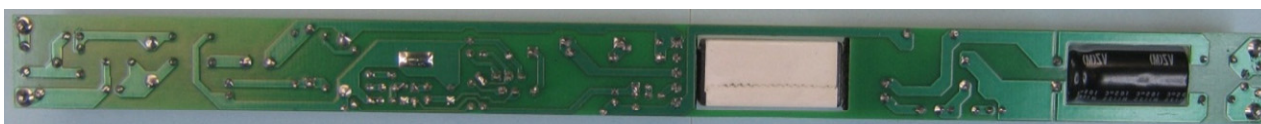

Figure 2 – Populated Circuit Board Photograph (Bottom View).

2 Power Supply Specification

The table below represents the minimum acceptable performance of the design. Actual performance is listed in the results section.

Description	Symbol	Min	Typ	Max	Units	Comment
Input Voltage Frequency	V_{IN} f_{LINE}	90	115 60	135	VAC Hz	2 Wire – no P.E.
Output Output Voltage Output Current Total Output Power Continuous Output Power	V_{OUT} I_{OUT} P_{OUT}	45	50 430	55	V mA W	$V_{OUT} = 50, V_{IN} = 115 \text{ VAC}, 25^\circ\text{C}$
Efficiency Full Load	η	86			%	Measured at 115 VAC, 25 °C
Environmental Conducted EMI Safety Surge (1.2 μ / 50 μ) Differential Mode (L1-L2)						CISPR 15B / EN55015B Isolated 1 kV
Power Factor		0.98				Measured at $V_{OUT(TYP)}$, $I_{OUT(TYP)}$ and 115 VAC, 60 Hz
Harmonic Currents						EN 61000-3-2 Class C
Ambient Temperature	T_{AMB}			40	°C	Enclosure external, free convection, sea level



3 Schematic

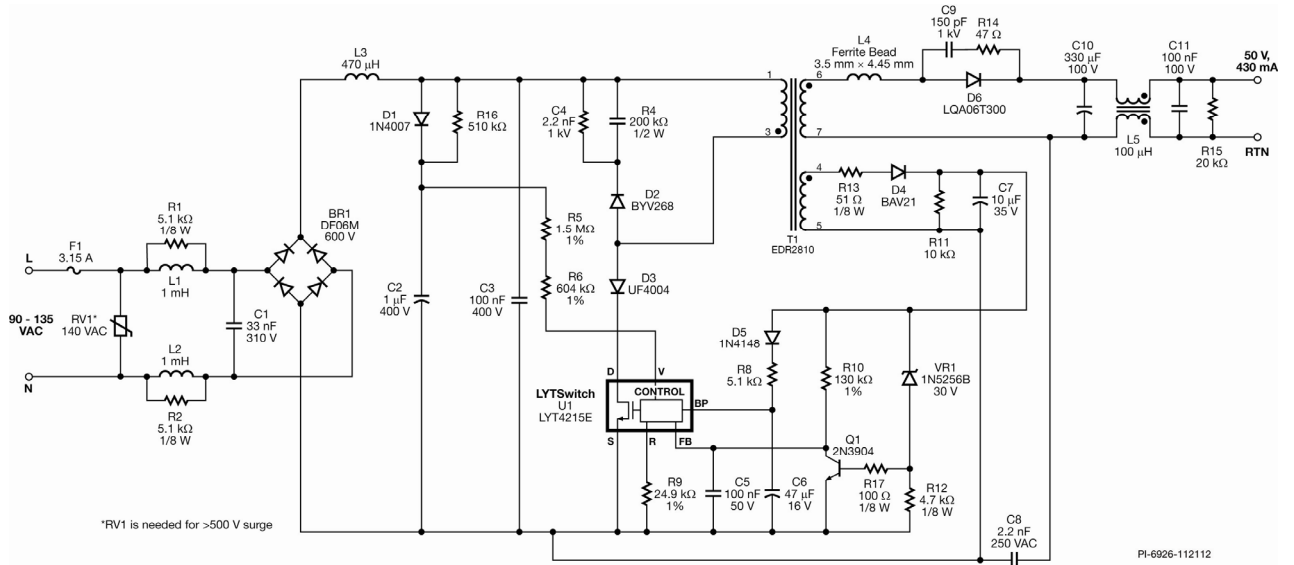

Figure 3 – Schematic.



4 Circuit Description

The LYTSwitch device is a controller with an integrated 650 V power MOSFET for use in LED driver applications. The LYTSwitch is configured for use in a single-stage flyback topology which provides a primary side regulated constant current output while maintaining high power factor from the AC input.

4.1 Input Filtering

Fuse F1 provides protection from component failure and RV1 provides a clamp to limit the maximum voltage during 1 kV differential line surge events. A 140 VAC rated part was selected, being slightly above the maximum specified operating voltage of 135 VAC. Diode bridge BR1 rectifies the AC line voltage with capacitor C3 providing a low impedance path (decoupling) for the primary switching current.

Input EMI filtering is provided by differential inductors L1, L2, L3, X capacitor C1, and Y capacitor C8. Resistors R1 and R2 across L1 and L2 damp any LC resonances due to the filter components and the AC line impedance, which would ordinarily show up on the conducted EMI measurements.

4.2 LYTSwitch Primary

One side of the transformer (T1) is connected to the DC bus and the other to the DRAIN (D) pin of the LYTSwitch through the blocking diode D3. During the on-time of the power MOSFET, current ramps through the primary, storing energy which is then delivered to the output during the power MOSFET off-time. An EDR2810 core size was selected to meet both the power handling and size requirements of the design.

To provide peak line voltage information to U1 the incoming rectified AC peak charges C2 via D1. This is then fed into the VOLTAGE MONITOR (V) pin of U1 as a current via R5 and R6.

The V pin current and the FEEDBACK (FB) pin current are used internally to control the average output LED current. For non-dimming applications a 24.9 k Ω resistor is used on the REFERENCE (R) pin (R9) and 2.1 M Ω (R5 and R6) on the V pin.

During the power MOSFET off-time, D2, R4, and C4 clamp the drain voltage to a safe level due to the effects of leakage inductance.

Diode D4, C7, R13, and R11 generate a primary bias supply from an auxiliary winding on the transformer. Resistors R13, R11, and C7 provide filtering so that the bias voltage tracks the output voltage closely (to maintain constant output current with changes in LED voltage).

Capacitor C6 provides local decoupling for the BYPASS (BP) pin of U1 which is the supply pin for the internal controller. During start-up, C6 is charged to ~6 V from an internal high-voltage current source connected to the D pin. Once charged U1 starts



switching at which point the operating supply current is provided from the bias supply via R8. Capacitor C6 also selects the output power mode, 47 μ F was selected (reduced power mode) to minimize the device dissipation and minimize heat sinking requirements.

4.3 Feedback

The bias winding voltage is used to sense the output voltage indirectly, eliminating secondary-side feedback components. The voltage on the bias winding is proportional to the output voltage (set by the turn ratio between the bias and secondary windings). Resistor R10 converts the bias voltage into a current, which is fed into the FB pin of U1. Capacitor C5 provides local decoupling for the FB pin of U1.

The internal engine within U1 combines the FB pin current, the V pin current, and internal drain current information to provide a constant output current while maintaining high input power factor.

In the case of an open load condition, Zener diode VR1 will limit the output voltage. The unit enters auto-restart operation when Q1 turns on, with Zener diode VR1 setting the overvoltage limit.

4.4 Output Rectification

The transformer secondary winding is rectified by D6 and filtered by C10, C11. For designs where higher ripple is acceptable, the output capacitance value can be reduced.

Resistor R14 and capacitor C9 across D6 reduce the peak reverse voltage stress on the output rectifier D6. Ferrite bead L4 and output common mode choke L5 reduce >10 MHz EMI noise together with capacitor C11.



5 PCB Layout

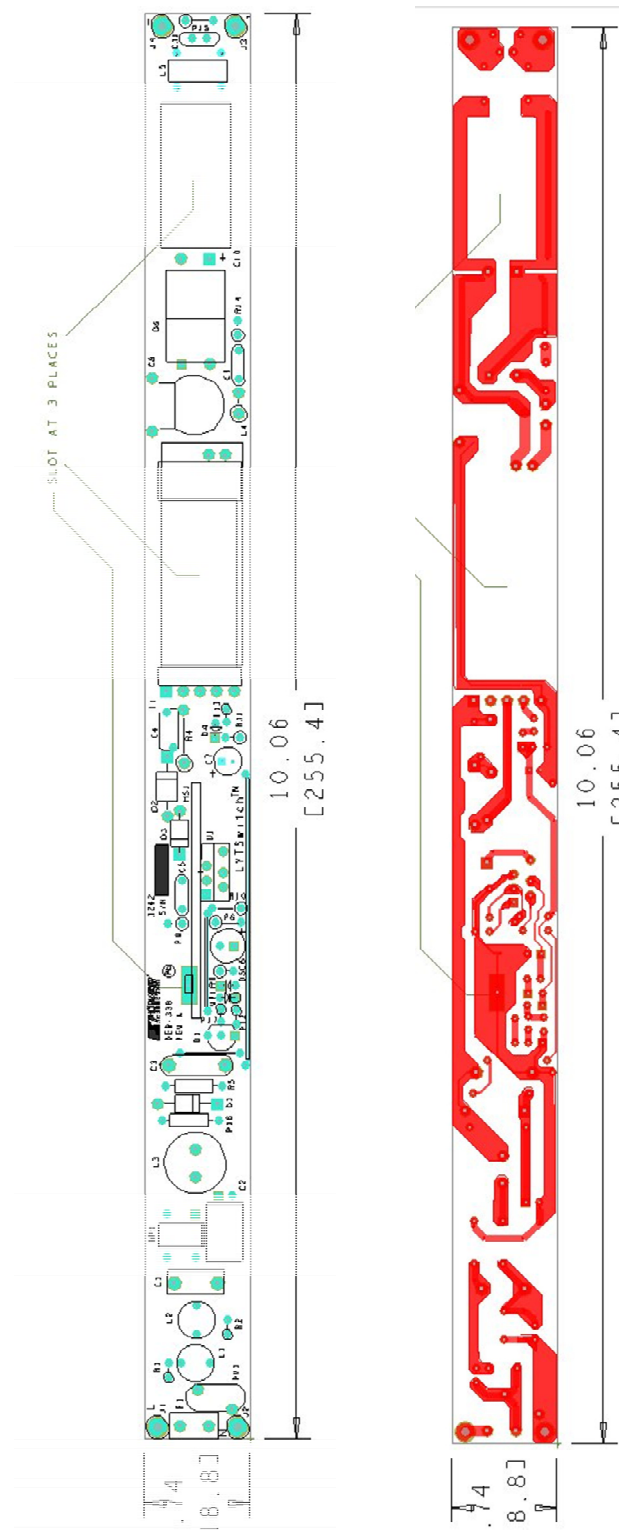

Figure 4 – PCB Layout, Outline and Silkscreen.



6 Bill of Materials

Item	Qty	Ref Des	Description	Mfg Part Number	Mfg
1	1	BR1	600 V, 1 A, Bridge Rectifier, DFM package	DF06M	Diodes, Inc.
2	1	C1	33 nF, 310 VAC, Polyester Film, X2	BFC233920333	Vishay
3	1	C2	1 μ F, 400 V, Electrolytic, (6.3 x 11)	EKMG401ELL1R0MF11D	United Chemi-Con
4	1	C3	100 nF, 400 V, Film	ECQ-E4104KF	Panasonic
5	1	C4	2200 pF, 1 kV, Disc Ceramic	562R5GAD22	Vishay
6	1	C5	100 nF, 50 V, Ceramic, Z5U, .2Lead Space	C317C104M5U5TA	Kemet
7	1	C6	47 μ F, 16 V, Electrolytic, Gen. Purpose, (6.3 x 7)	USA1C470MDD	Nichicon
8	1	C7	10 μ F, 35 V, Electrolytic, Gen Purpose, (5 x 7)	UPW1V100MDD6	Nichicon
9	1	C8	2.2 nF, Ceramic, Y1	440LD22-R	Vishay
10	1	C9	150 pF, 1 kV, Disc Ceramic	NCD151K1KVY5F	NIC Components
11	1	C10	3300 μ F, 100 V, Electrolytic, (12.5 x 25)	UVZ2A331MHD	Nichicon
12	1	C11	100 nF, 100 V, Ceramic, X7R	SR201C104KAR	AVX
13	1	D1	1000 V, 1 A, Rectifier, DO-41	1N4007-E3/54	Vishay
14	1	D2	400 V, 1 A, Ultrafast Recovery, 30 ns, SOD57	BYV26B	Philips
15	1	D3	400 V, 1 A, Ultrafast Recovery, 50 ns, DO-41	UF4004-E3	Vishay
16	1	D4	250 V, 250 mA, Fast Switching, DO-35	BAV21	Vishay
17	1	D5	75 V, 300 mA, Fast Switching, DO-35	1N4148TR	Vishay
18	1	D6	300 V, 6 A, TO-220AC	LQA06T300	Power Integrations
19	1	F1	3.15 A, 250 V, Slow, RST	507-1181	Belfuse
20	1	HS1	Heat Sink, Custom, Al, 3003, 0.062" Thk		Custom
21	2	L1 L2	1 mH, 0.30 A, Ferrite Core	CTCH895F-102K	CT Parts
22	1	L3	470 μ H, 0.38 A, Radial	TSL0808RA-471KR38-PF	TDK
23	1	L4	3.5 mm x 4.45 mm, 68 Ω at 100 MHz, #22 AWG hole, Ferrite Bead	2743001112	Fair-Rite
24	1	L5	Custom, 100 μ H, constructed on Core# 35T0375-10H from PI# 32-00275-00		Power Integrations
25	1	Q1	NPN, Small Signal BJT, 40 V, 0.2 A, TO-92	2N3904RLRAG	On Semi
26	2	R1 R2	5.1 k Ω , 5%, 1/8 W, Carbon Film	CFR-12JB-5K1	Yageo
27	1	R4	200 k Ω , 5%, 1/2 W, Carbon Film	CFR-50JB-200K	Yageo
28	1	R5	1.5 M Ω , 1%, 1/4 W, Metal Film	RNF14FTD1M50	Stackpole
29	1	R6	604 k Ω , 1%, 1/4 W, Metal Film	MFR-25FBF-604K	Yageo
30	1	R8	5.1 k Ω , 5%, 1/4 W, Carbon Film	CFR-25JB-5K1	Yageo
31	1	R9	24.9 k Ω , 1%, 1/4 W, Metal Film	MFR-25FBF-24K9	Yageo
32	1	R10	130 k Ω , 1%, 1/4 W, Metal Film	MFR-25FBF-130K	Yageo
33	1	R11	10 k Ω , 5%, 1/4 W, Carbon Film	CFR-25JB-10K	Yageo
34	1	R12	4.7 k Ω , 5%, 1/8 W, Carbon Film	CFR-12JB-4K7	Yageo
35	1	R13	51 Ω , 5%, 1/8 W, Carbon Film	CFR-12JB-51R	Yageo
36	1	R14	47 Ω , 5%, 1/4 W, Carbon Film	CFR-25JB-47R	Yageo
37	1	R15	20 k Ω , 5%, 1/4 W, Carbon Film	CFR-25JB-20K	Yageo
38	1	R16	510 k Ω , 5%, 1/4 W, Carbon Film	CFR-25JB-510K	Yageo
39	1	R17	100 Ω , 5%, 1/8 W, Carbon Film	CFR-12JB-100R	Yageo
40	1	RV1	140 V, 12 J, 7 mm, RADIAL	V140LA2P	Littlefuse
41	1	T1	Bobbin, EDR-2810, Horizontal, 9 pins		SBEF
42	1	U1	LYTSwitch, eSIP-7C	LYT4215E	Power Integrations
43	1	VR1	30 V, 5%, 500 mW, DO-35	1N5256B	Microsemi



7 Common Mode Inductor Specification

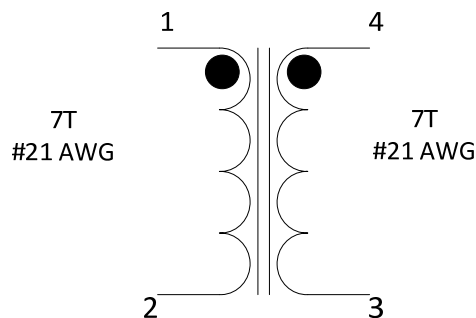

Figure 5 – CMC Electrical Diagram.

7.1 Electrical Specifications

Inductance (LCM)	Pins 1-2 or 3-4 measured at 100 kHz.	90 μ H min.
Leakage (LL)	Pins 1-2 with pins 3-4 shorted or versa at 100 kHz.	1 μ H

7.2 Materials

Item	Description
[1]	Toroid Ferrite Core: 35T0375-10H Dimension: OD: 9.53 mm / ID: 4.75 mm / HT: 3.18 mm.
[2]	Magnet Wire: #24 AWG, Heavy Nyleze.

7.3 Winding Instructions

- Wind each winding individually and separated from each other.
- This will result in required leakage.
- Do not interleave both the windings.



8 Transformer Specification

8.1 Electrical Diagram

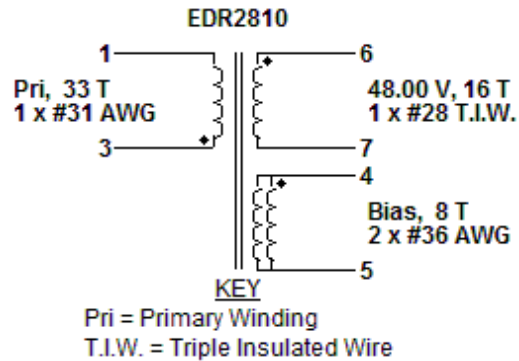

Figure 6 – Transformer Electrical Diagram.

8.2 Electrical Specifications

Electrical Strength	1 second, 60 Hz, from pins 1-3 to pins 6-7.	3000 VAC
Primary Inductance	Pins 1-3, all other windings open, measured at 100 kHz, 0.4 V _{RMS} .	925 μH, ±10%
Resonant Frequency	Pins 1-3, all other windings open.	800 kHz (Min.)
Primary Leakage Inductance	Pins 1-3, with pins 6-7 shorted, measured at 100 kHz, 0.4 V _{RMS} .	50 μH (Max.)

8.3 Materials

Item	Description
[1]	Core: EDR2810, AL= 849 nH/N ² .
[2]	Bobbin: Vertical Generic, 5 pri. + 2 sec.
[3]	Barrier Tape: Polyester film [1 mil (25 μm) base thickness], 4.60 mm wide.
[4]	Copper Tape: 2 mil thick.
[5]	Magnet Wire: #31 AWG, Solderable Double Coated.
[6]	Magnet Wire: #36 AWG, Solderable Double Coated.
[8]	Triple Insulated Wire: #28 AWG.
[8]	Varish.

8.4 Transformer Build Diagram

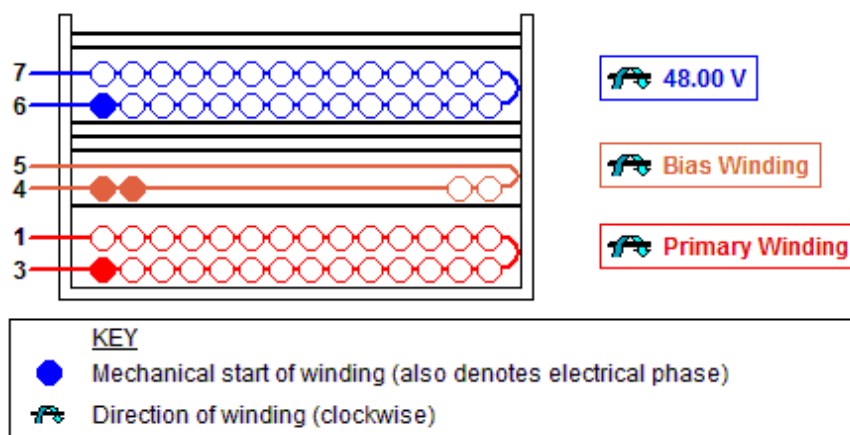

Figure 7 – Transformer Build Diagram.

8.5 Transformer Construction

Bobbin Preparation	Pull-out pin number 8. Position the bobbin such that the pins are on the left side of the bobbin chuck. Machine rotates in forward direction.
WDG1 Primary 1	Start at pin 3; wind with firm tension 33 turns of item [5] in 2 layers from left to right. At the end of 1st layer, continue to wind the next layer from right to left. On the final layer, spread the winding evenly across entire bobbin. Finish this winding on pin(s) 1
Insulation	1 layer of tape [3] for insulation.
WDG2 Bias	Start on pin(s) 4 and wind 8 turns (x 2 filar) of item [6]. Wind in same rotational direction as primary winding. Spread the winding evenly across entire bobbin. Finish this winding on pin(s) 5.
Insulation	3 layer of tape [3] for insulation.
WDG3 Secondary	Start on pin(s) 6 and wind 16 turns (x 1 filar) of item [7]. Spread the winding evenly across entire bobbin. Wind in same rotational direction as primary winding. Finish this winding on pin(s) 7.
Insulation	2 layers of tape [3] for insulation.
Assemble Core	Assemble and secure the cores.
Flux Band	Construct a flux band by wrapping a single shorted turn of item [4] around the outside of windings and core halves with tight tension. Make an electrical connection to pin(s) 5 using wire. Add 3 layers of tape, item [3], for insulation.
Finish	Varnish transformer assembly.



9 Transformer Design Spreadsheet

ACDC_LYTSwitch_101112; Rev.1.0; Copyright Power Integrations 2012	INPUT	OUTPUT	UNIT	LYTSwitch_101112: Flyback Transformer Design Spreadsheet
ENTER APPLICATION VARIABLES				
Dimming required	No	NO		Select 'YES' option if dimming is required. Otherwise select 'NO'.
VACMIN		90	V	Minimum AC Input Voltage
VACMAX		132	V	Maximum AC input voltage
fL		60	Hz	AC Mains Frequency
VO	50	50	V	Typical output voltage of LED string at full load
VO_MAX		55	V	Maximum expected LED string Voltage.
VO_MIN		45	V	Minimum expected LED string Voltage.
V_OVP		58	V	Over-voltage protection setpoint
IO	0.43	0.43	A	Typical full load LED current
PO		21.5	W	Output Power
n	0.85	0.85		Estimated efficiency of operation
VB	20	20	V	Bias Voltage
ENTER LYTSwitch VARIABLES				
LYTSwitch	LYT4215	LYT4215	Universal	115 Doubled/230V
Current Limit Mode	RED	RED		Select "RED" for reduced Current Limit mode or "FULL" for Full current limit mode
ILIMITMIN		1.42	A	Minimum current limit
ILIMITMAX		1.66	A	Maximum current limit
fS		132000	Hz	Switching Frequency
fSmin		124000	Hz	Minimum Switching Frequency
fSmax		140000	Hz	Maximum Switching Frequency
IV		76.02	uA	V pin current
RV	2.1	2.1	M-ohms	Upper V pin resistor
RV2		1E+12	M-ohms	Lower V pin resistor
IFB	180	180	uA	FB pin current (85 uA < IFB < 210 uA)
RFB1		94.44	k-ohms	FB pin resistor
VDS		10	V	LYTSwitch on-state Drain to Source Voltage
VD		0.5	V	Output Winding Diode Forward Voltage Drop (0.5 V for Schottky and 0.8 V for PN diode)
VDB		0.7	V	Bias Winding Diode Forward Voltage Drop
Key Design Parameters				
KP	0.6084	0.61		Ripple to Peak Current Ratio (For PF > 0.9, 0.4 < KP < 0.9)
LP		925.00	uH	Primary Inductance
VOR	105	105.00	V	Reflected Output Voltage.
Expected IO (average)		0.41	A	Expected Average Output Current
KP_VACMAX		0.64		Expected ripple current ratio at VACMAX
TON_MIN		2.73	us	Minimum on time at maximum AC input voltage
PCLAMP		0.19	W	Estimated dissipation in primary clamp
ENTER TRANSFORMER CORE/CONSTRUCTION VARIABLES				
Core Type	EDR2810	EDR2810		
Bobbin			P/N:	#N/A
AE	0.84	0.84	cm^2	Core Effective Cross Sectional Area
LE	2.46	2.46	cm	Core Effective Path Length
AL	5700	5700	nH/T^2	Ungapped Core Effective Inductance
BW	4.6	4.6	mm	Bobbin Physical Winding Width
M		0	mm	Safety Margin Width (Half the Primary to Secondary Creepage Distance)



L		3		Number of Primary Layers
NS	16	16		Number of Secondary Turns
DC INPUT VOLTAGE PARAMETERS				
VMIN		127.28	V	Peak input voltage at VACMIN
VMAX		186.68	V	Peak input voltage at VACMAX
CURRENT WAVEFORM SHAPE PARAMETERS				
DMAX		0.47		Minimum duty cycle at peak of VACMIN
IAVG		0.23	A	Average Primary Current
IP		0.93	A	Peak Primary Current (calculated at minimum input voltage VACMIN)
IRMS		0.33	A	Primary RMS Current (calculated at minimum input voltage VACMIN)
TRANSFORMER PRIMARY DESIGN PARAMETERS				
LP		925.00	uH	Primary Inductance
LP_TOL		10.00		Tolerance of primary inductance
NP		33.27		Primary Winding Number of Turns
NB		6.56		Bias Winding Number of Turns
ALG		835.81	nH/T ²	Gapped Core Effective Inductance
BM		3062.70	Gauss	Maximum Flux Density at PO, VMIN (BM<3100)
BP		3573.15	Gauss	Peak Flux Density (BP<3700)
BAC		931.60	Gauss	AC Flux Density for Core Loss Curves (0.5 X Peak to Peak)
ur		1328.37		Relative Permeability of Ungapped Core
LG		0.11	mm	Gap Length (Lg > 0.1 mm)
BWE		13.80	mm	Effective Bobbin Width
OD		0.41	mm	Maximum Primary Wire Diameter including insulation
INS		0.06	mm	Estimated Total Insulation Thickness (= 2 * film thickness)
DIA		0.35	mm	Bare conductor diameter
AWG		28.00	AWG	Primary Wire Gauge (Rounded to next smaller standard AWG value)
CM		161.27	Cmils	Bare conductor effective area in circular mils
CMA		485.20	Cmils/A mp	Primary Winding Current Capacity (200 < CMA < 600)
TRANSFORMER SECONDARY DESIGN PARAMETERS (SINGLE OUTPUT EQUIVALENT)				
Lumped parameters				
ISP		1.92	A	Peak Secondary Current
ISRMS		0.68	A	Secondary RMS Current
IRIPPLE		0.53	A	Output Capacitor RMS Ripple Current
CMS		136.19	Cmils	Secondary Bare Conductor minimum circular mils
AWGS		28	AWG	Secondary Wire Gauge (Rounded up to next larger standard AWG value)
DIAS		0.32	mm	Secondary Minimum Bare Conductor Diameter
ODS		0.29	mm	Secondary Maximum Outside Diameter for Triple Insulated Wire
VOLTAGE STRESS PARAMETERS				
VDRAIN		402.85	V	Estimated Maximum Drain Voltage assuming maximum LED string voltage
PIVS		148.12	V	Output Rectifier Maximum Peak Inverse Voltage
PIVB		60.14	V	Bias Rectifier Maximum Peak Inverse Voltage



10 Heat Sink Assembly

10.1 Heat Sink Fabrication Drawing

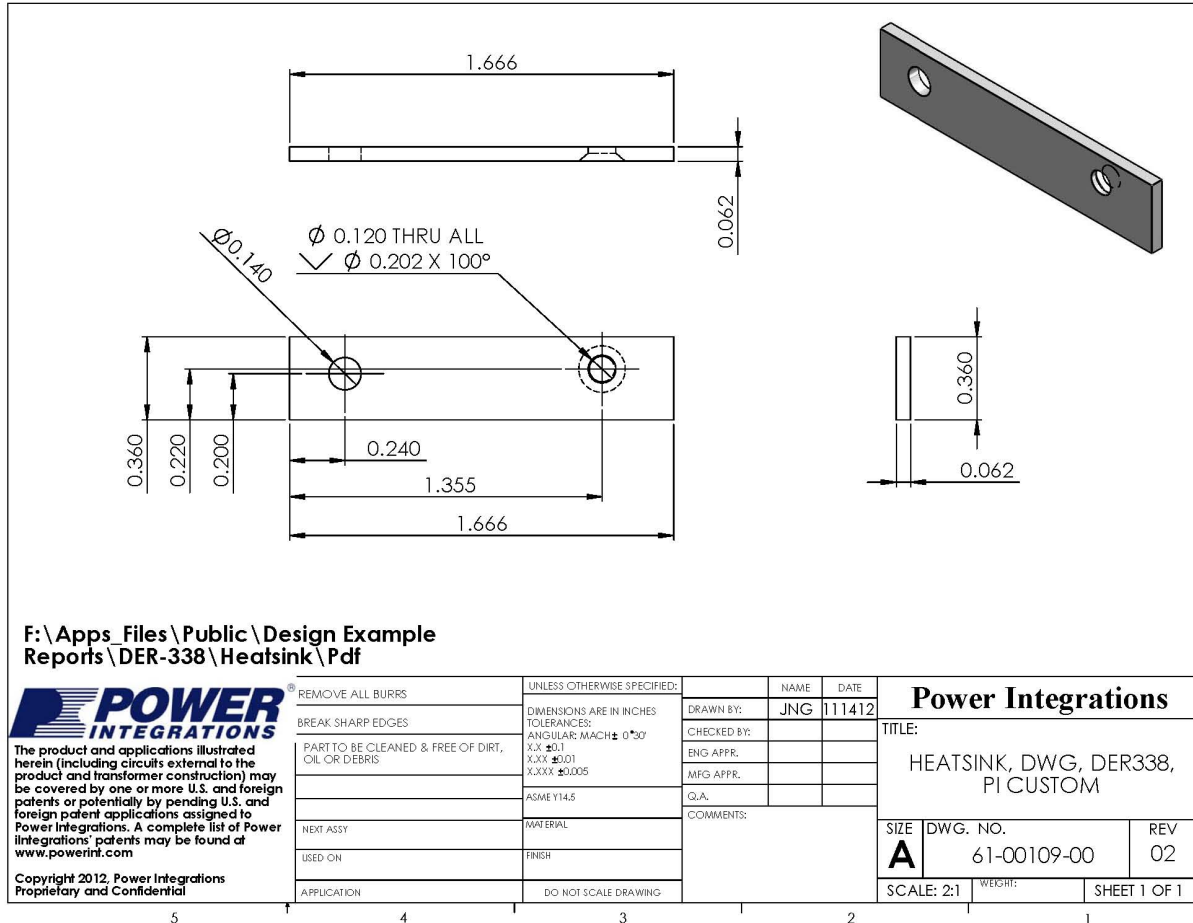
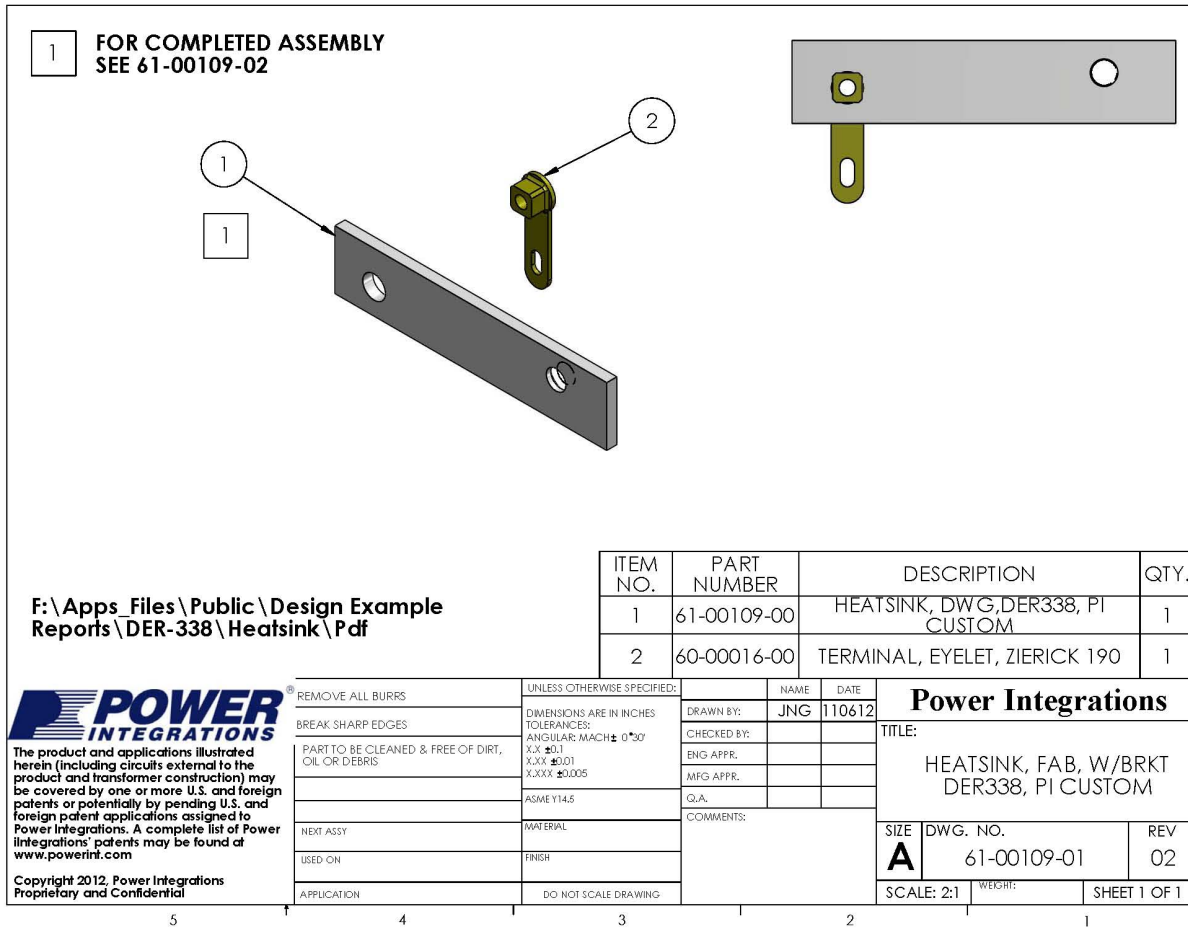

Figure 8 – Heat Sink Fabrication Drawing.



10.2 Heat Sink Assembly Drawing



10.3 Heat Sink and LYTSwitch Assembly Drawing

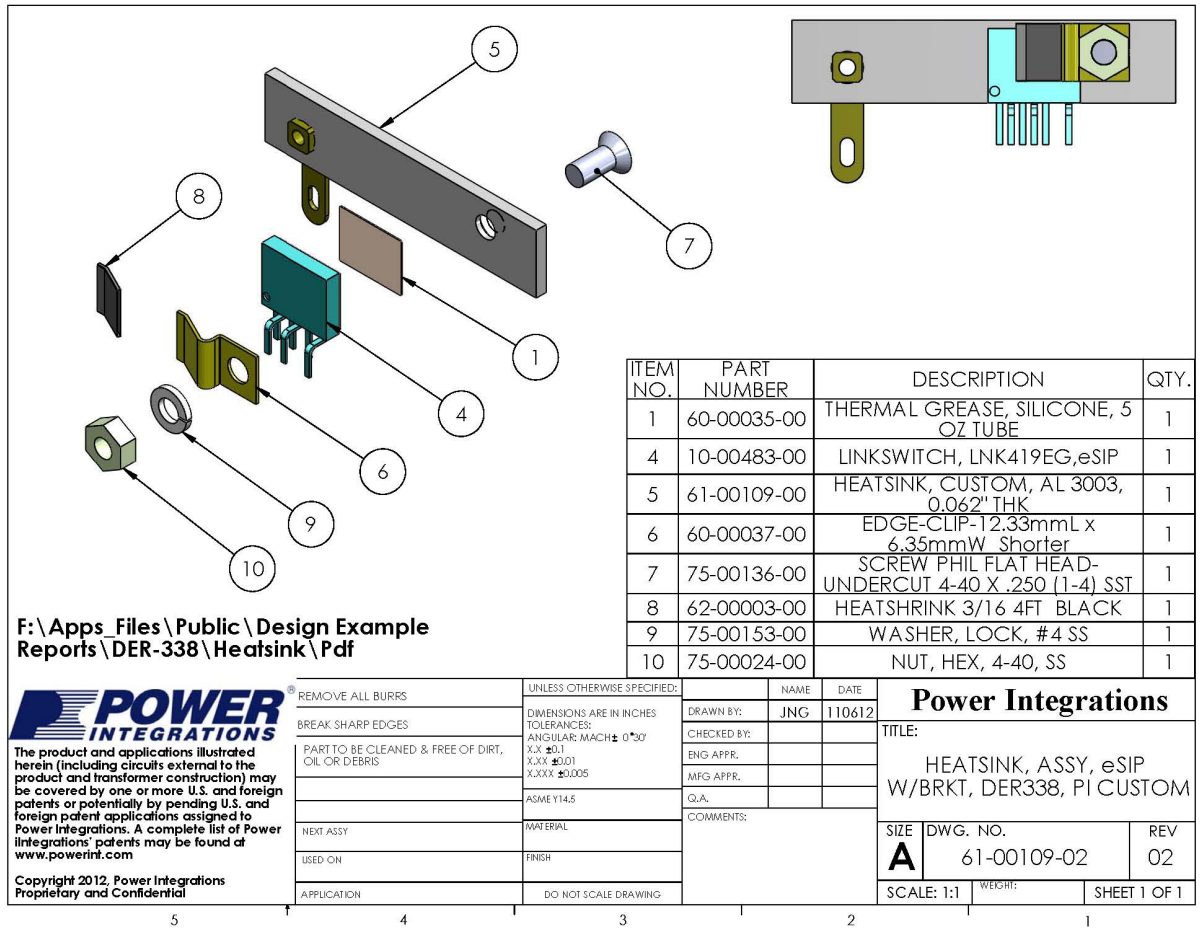

Figure 10 – Heat Sink and LYTSwitch Assembly Drawing.



11 Performance Data

All measurements performed at room temperature using an LED load. The following data were measured using 3 sets of loads to represent a voltage of 45 V ~ 55 V. The table in Section 11.6 shows complete test data values.

11.1 Efficiency

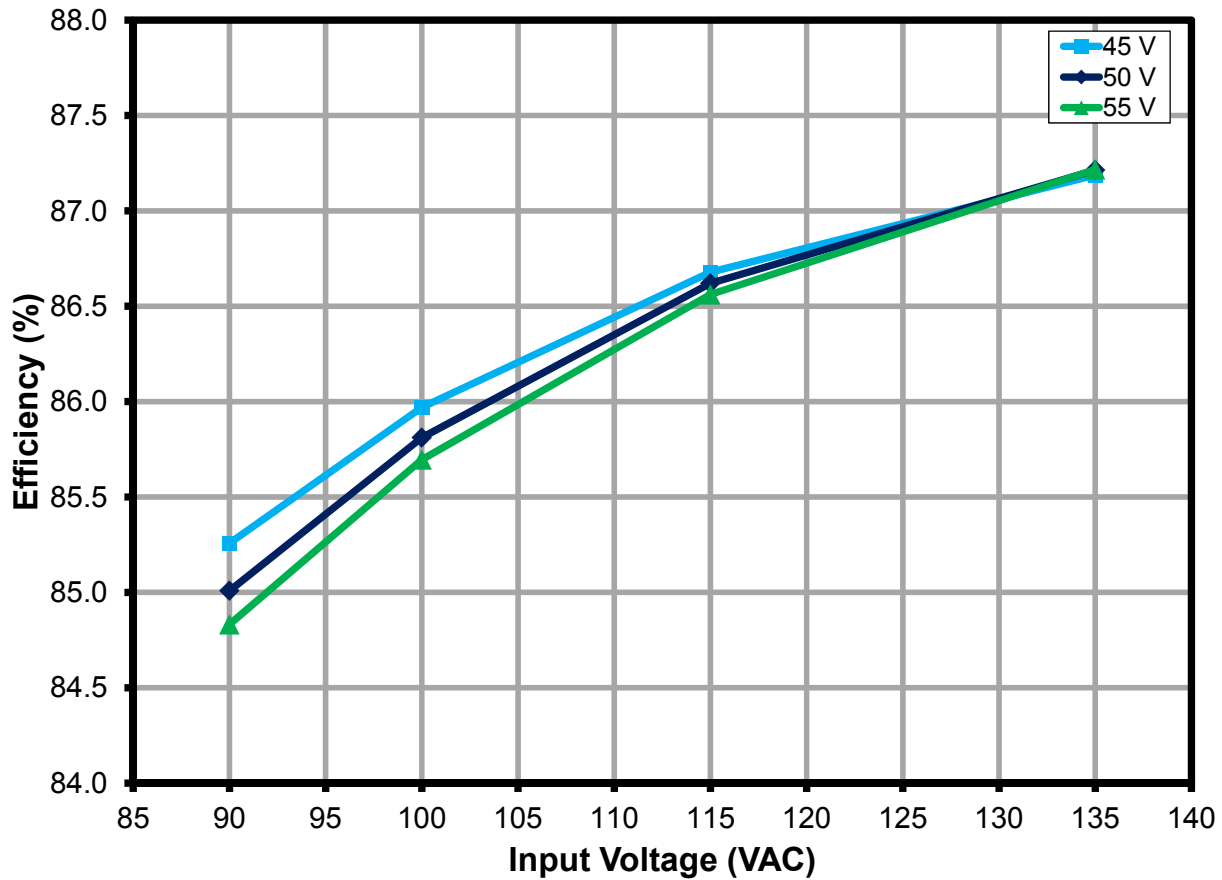

Figure 11 – Efficiency vs. Line and Load.



11.2 Line and Load Regulation

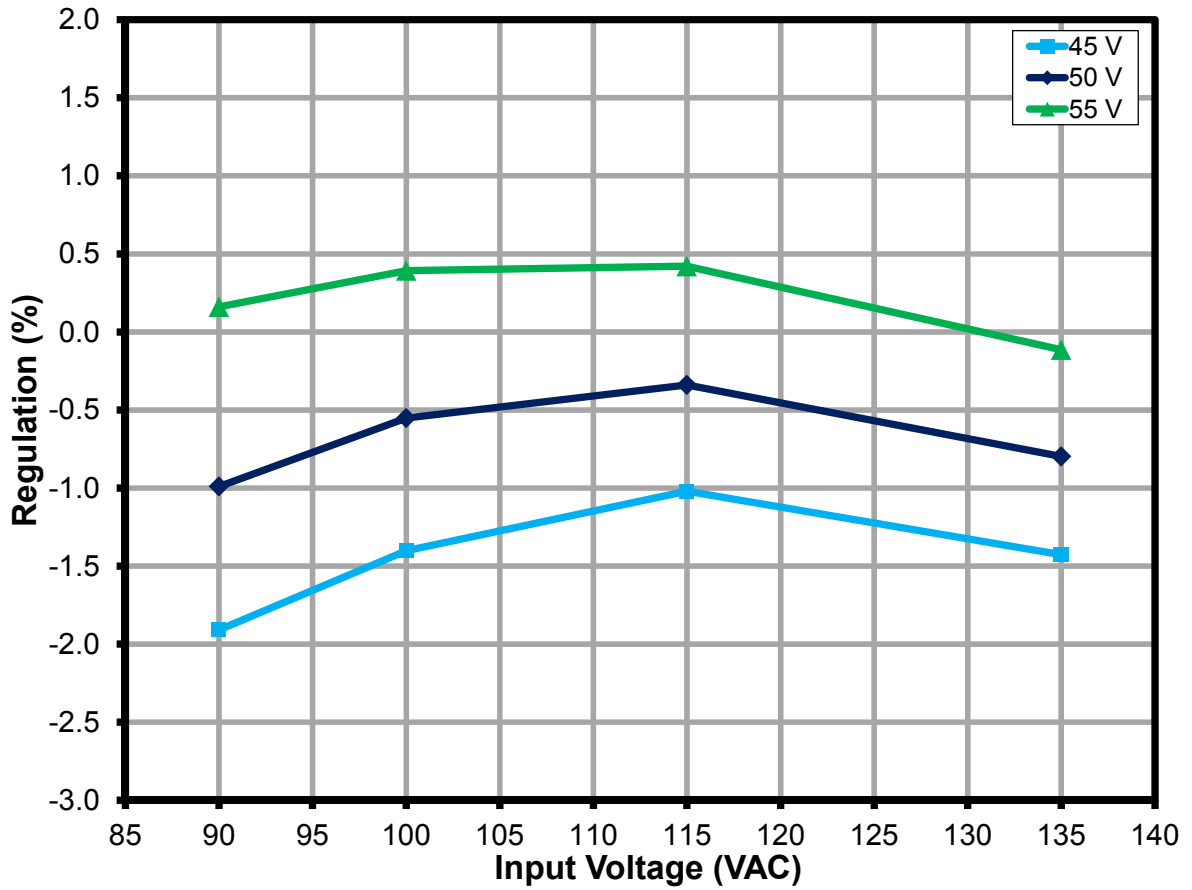

Figure 12– Regulation vs. Line and Load.



11.3 Power Factor

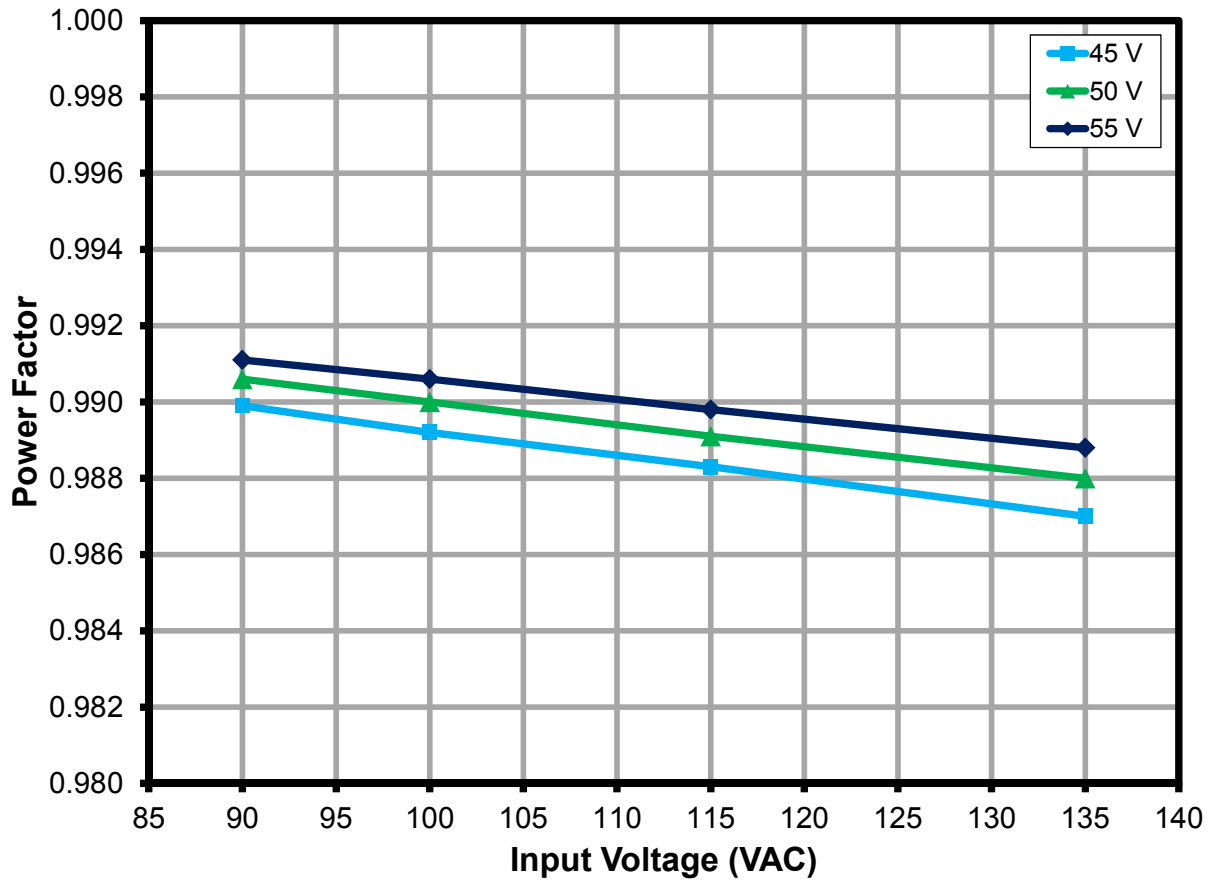

Figure 13 – Power Factor vs. Line and Load.



11.4 A-THD

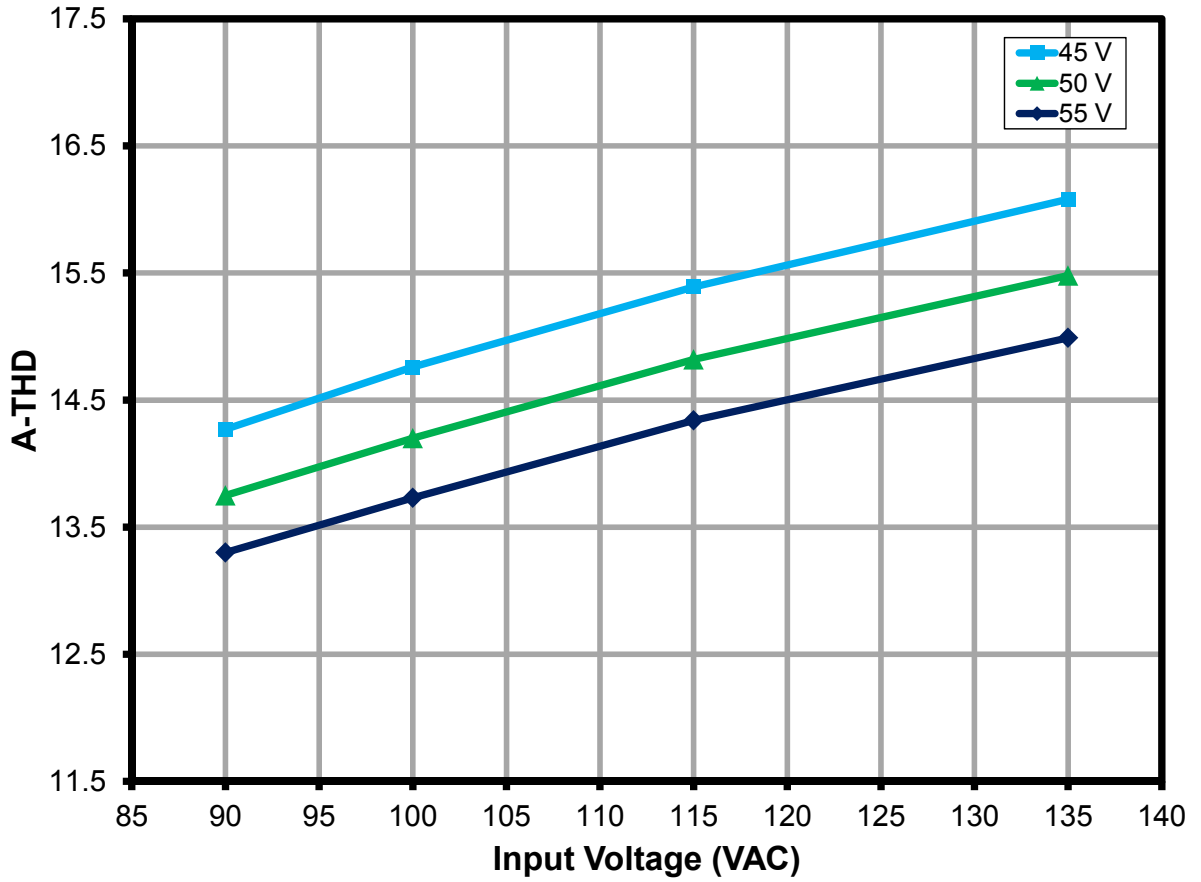

Figure 14 – A-THD vs. Line and Load.



11.5 Harmonic Currents

The design was made to meet the IEC61000-3-2 Limits for Class C equipment (section 7.3-a) for an Active input power of > 25 W, which states that the harmonic currents shall not exceed the related limits given in Table 2 - Limits for Class C equipment. For multiple units operating in parallel, all units can pass Class C limits as well.

11.5.1 45 V LED Load

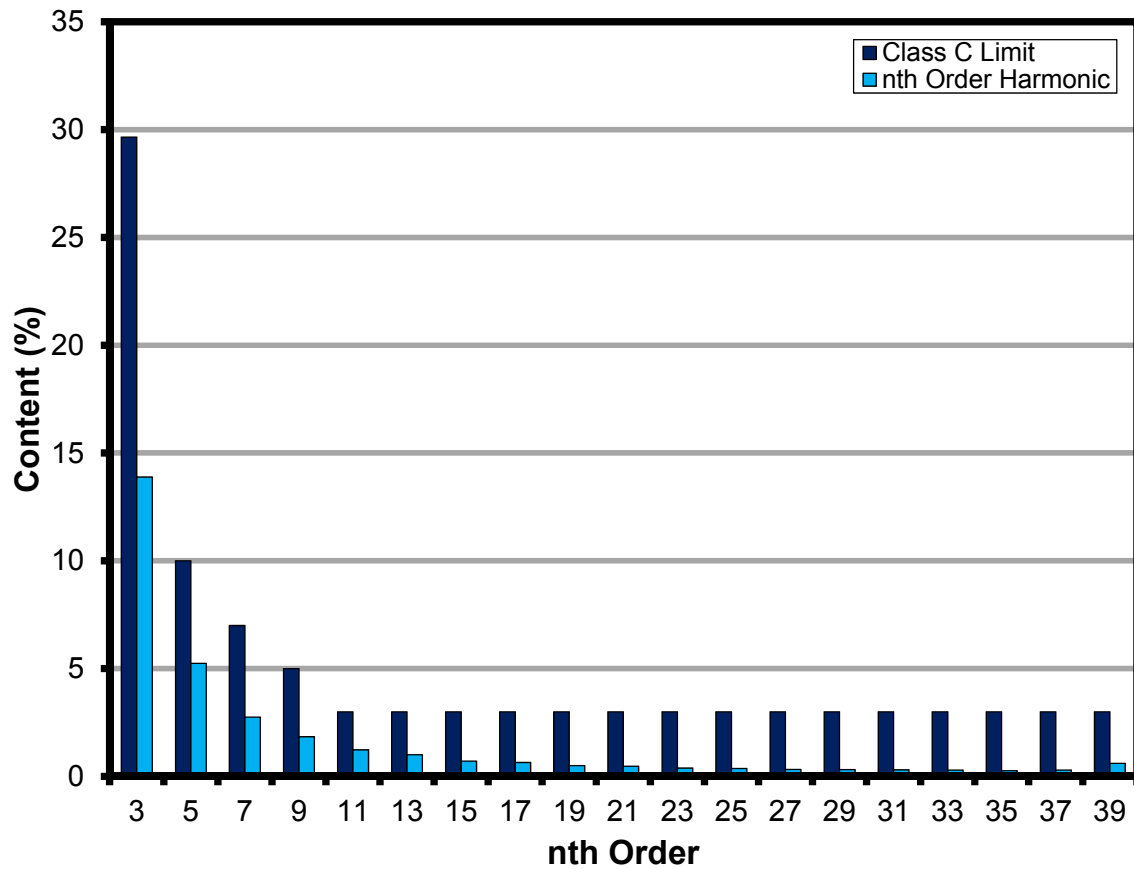

Figure 15 – 45 V LED Load Input Current Harmonics at 115 VAC, 60 Hz.



11.5.2 50 V LED Load

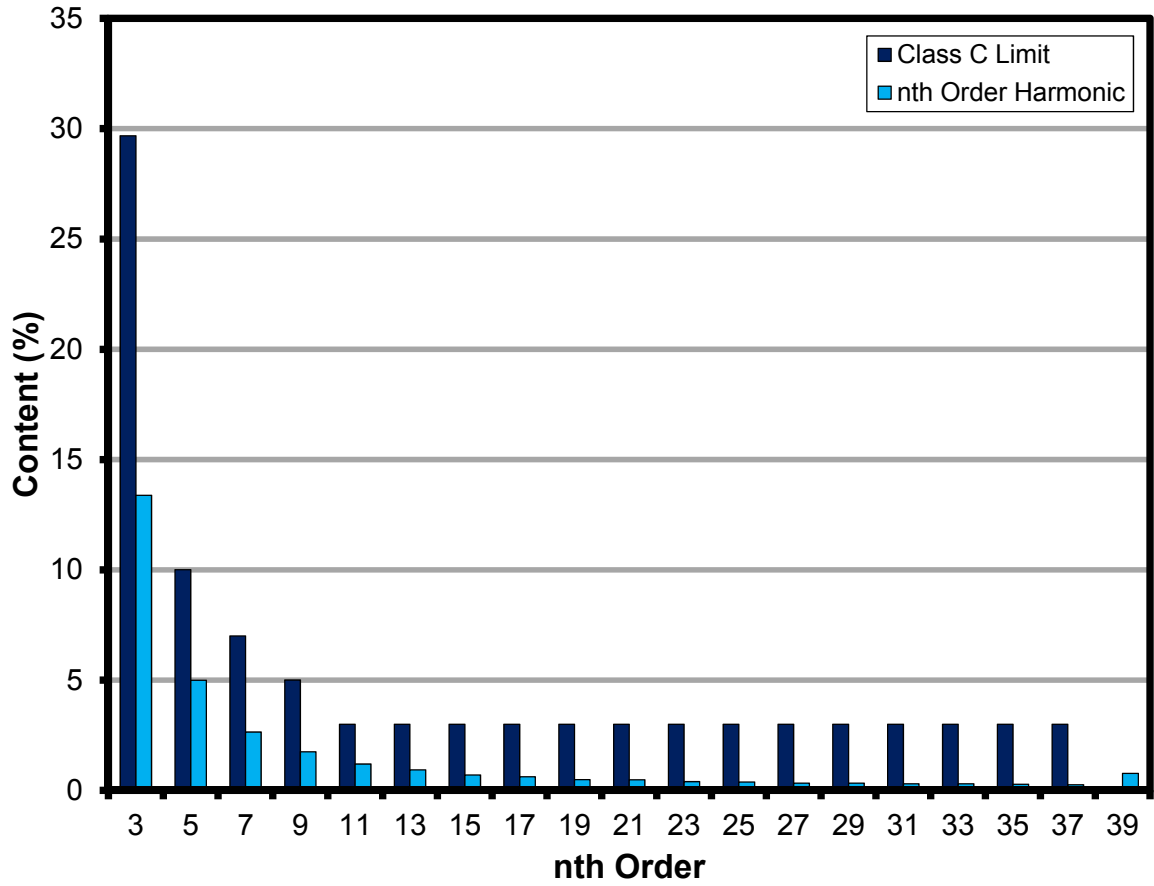

Figure 16 – 50 V LED Load Input Current Harmonics at 115 VAC, 60 Hz.



11.5.3 55 V LED Load

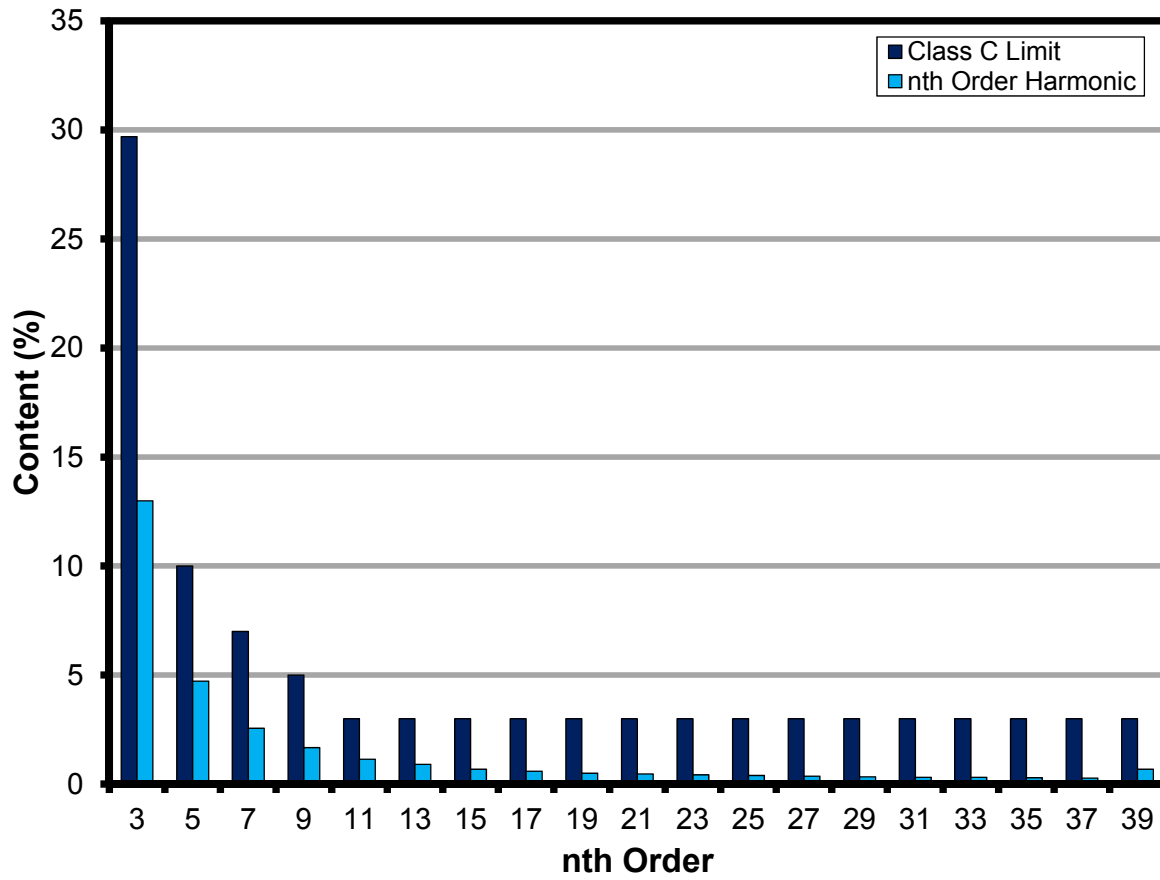

Figure 17 – 55 V LED Load Input Current Harmonics at 115 VAC, 60 Hz.



11.6 Test Data

All measurements were taken with the board at open frame, 25 °C ambient, and 60 Hz line frequency.

11.6.1 Test Data, 45 V LED Load

Input		Input Measurement					Load Measurement			Calculation		
VAC (V _{RMS})	Freq (Hz)	V _{IN} (V _{RMS})	I _{IN} (mA _{RMS})	P _{IN} (W)	PF	%ATHD	V _{OUT} (V _{DC})	I _{OUT} (mA _{DC})	P _{OUT} (W)	P _{CAL} (W)	Efficiency (%)	Loss (W)
90	60	89.90	249.70	22.221	0.990	14.27	44.5730	421.790	18.945	18.80	85.26	3.28
100	60	99.94	224.01	22.146	0.989	14.76	44.5660	423.970	19.039	18.89	85.97	3.11
115	60	114.96	194.05	22.047	0.988	15.39	44.5620	425.610	19.110	18.97	86.68	2.94
135	60	134.96	163.78	21.816	0.987	16.08	44.5420	423.860	19.021	18.88	87.19	2.80

11.6.2 Test Data, 50 V LED Load

Input		Input Measurement					Load Measurement			Calculation		
VAC (V _{RMS})	Freq (Hz)	V _{IN} (V _{RMS})	I _{IN} (mA _{RMS})	P _{IN} (W)	PF	%ATHD	V _{OUT} (V _{DC})	I _{OUT} (mA _{DC})	P _{OUT} (W)	P _{CAL} (W)	Efficiency (%)	Loss (W)
90	60	89.90	280.67	24.994	0.991	13.75	49.5590	425.740	21.247	21.10	85.01	3.75
100	60	99.94	251.31	24.864	0.990	14.2	49.5470	427.630	21.336	21.19	85.81	3.53
115	60	114.96	217.04	24.679	0.989	14.82	49.5400	428.540	21.377	21.23	86.62	3.30
135	60	134.95	182.88	24.385	0.988	15.48	49.5190	426.570	21.267	21.12	87.21	3.12

11.6.3 Test Data, 55 V LED Load

Input		Input Measurement					Load Measurement			Calculation		
VAC (V _{RMS})	Freq (Hz)	V _{IN} (V _{RMS})	I _{IN} (mA _{RMS})	P _{IN} (W)	PF	%ATHD	V _{OUT} (V _{DC})	I _{OUT} (mA _{DC})	P _{OUT} (W)	P _{CAL} (W)	Efficiency (%)	Loss (W)
90	60	89.90	309.39	27.566	0.991	13.3	53.9570	430.690	23.385	23.24	84.83	4.18
100	60	99.94	276.17	27.341	0.991	13.73	53.9370	431.690	23.430	23.28	85.70	3.91
115	60	114.96	237.84	27.064	0.990	14.34	53.9210	431.810	23.427	23.28	86.56	3.64
135	60	134.95	200.08	26.700	0.989	14.99	53.8900	429.510	23.287	23.15	87.22	3.41



11.6.4 115 VAC 60 Hz, 45 V LED Load Harmonics Data

V	Freq	I (mA)	P	PF	%THD
115	60.00	194.05	22.0470	0.9883	15.39
nth Order	mA Content	% Content	mA Limit <25 W	% Limit >25 W	Remarks
1	191.84				
2	0.07	0.04%		2.00%	Pass
3	26.64	13.89%	149.9196	29.65%	Pass
5	10.06	5.24%	83.7786	10.00%	Pass
7	5.28	2.75%	44.0940	7.00%	Pass
9	3.54	1.85%	22.0470	5.00%	Pass
11	2.37	1.24%	15.4329	3.00%	Pass
13	1.93	1.01%	13.0586	3.00%	Pass
15	1.36	0.71%	11.3175	3.00%	Pass
17	1.23	0.64%	9.9860	3.00%	Pass
19	0.96	0.50%	8.9348	3.00%	Pass
21	0.90	0.47%	8.0839	3.00%	Pass
23	0.75	0.39%	7.3810	3.00%	Pass
25	0.71	0.37%	6.7905	3.00%	Pass
27	0.62	0.32%	6.2875	3.00%	Pass
29	0.61	0.32%	5.8539	3.00%	Pass
31	0.58	0.30%	5.4762	3.00%	Pass
33	0.56	0.29%	5.1443	3.00%	Pass
35	0.51	0.27%	4.8503	3.00%	Pass
37	0.56	0.29%	4.5882	3.00%	Pass
39	1.16	0.60%	4.3529	3.00%	Pass



11.6.5 115 VAC 60 Hz, 50 V LED Load Harmonics Data

V	Freq	I (mA)	P	PF	%THD
115	60.00	217.04	24.6790	0.9891	14.82
nth Order	mA Content	% Content	mA Limit <25 W	% Limit >25 W	Remarks
1	214.72				
2	0.06	0.03%		2.00%	Pass
3	28.72	13.38%	167.8172	29.67%	Pass
5	10.73	5.00%	93.7802	10.00%	Pass
7	5.68	2.65%	49.3580	7.00%	Pass
9	3.75	1.75%	24.6790	5.00%	Pass
11	2.57	1.20%	17.2753	3.00%	Pass
13	2.00	0.93%	14.6176	3.00%	Pass
15	1.50	0.70%	12.6686	3.00%	Pass
17	1.33	0.62%	11.1781	3.00%	Pass
19	1.05	0.49%	10.0015	3.00%	Pass
21	1.03	0.48%	9.0490	3.00%	Pass
23	0.85	0.40%	8.2621	3.00%	Pass
25	0.81	0.38%	7.6011	3.00%	Pass
27	0.70	0.33%	7.0381	3.00%	Pass
29	0.70	0.33%	6.5527	3.00%	Pass
31	0.65	0.30%	6.1299	3.00%	Pass
33	0.64	0.30%	5.7584	3.00%	Pass
35	0.59	0.27%	5.4294	3.00%	Pass
37	0.55	0.26%	5.1359	3.00%	Pass
39	1.65	0.77%	4.8725	3.00%	Pass



11.6.6 115 VAC 60 Hz, 55 V LED Load Harmonics Data

V	Freq	I (mA)	P	PF	%THD
115	60.00	237.84	27.0640	0.9898	14.34
nth Order	mA Content	% Content	mA Limit <25 W	% Limit >25 W	Remarks
1	235.40				
2	0.06	0.03%		2.00%	Pass
3	30.58	12.99%	184.0352	29.69%	Pass
5	11.11	4.72%	102.8432	10.00%	Pass
7	6.02	2.56%	54.1280	7.00%	Pass
9	3.94	1.67%	27.0640	5.00%	Pass
11	2.68	1.14%	18.9448	3.00%	Pass
13	2.13	0.90%	16.0302	3.00%	Pass
15	1.60	0.68%	13.8929	3.00%	Pass
17	1.38	0.59%	12.2584	3.00%	Pass
19	1.17	0.50%	10.9680	3.00%	Pass
21	1.10	0.47%	9.9235	3.00%	Pass
23	1.00	0.42%	9.0606	3.00%	Pass
25	0.93	0.40%	8.3357	3.00%	Pass
27	0.86	0.37%	7.7183	3.00%	Pass
29	0.78	0.33%	7.1860	3.00%	Pass
31	0.73	0.31%	6.7223	3.00%	Pass
33	0.73	0.31%	6.3149	3.00%	Pass
35	0.70	0.30%	5.9541	3.00%	Pass
37	0.63	0.27%	5.6322	3.00%	Pass
39	1.61	0.68%	5.3434	3.00%	Pass



12 Thermal Performance

Images captured after running for >30 minutes at room temperature (25 °C), open frame for the conditions specified.

12.1 $V_{IN} = 115 \text{ VAC}, 60 \text{ Hz}, 50 \text{ V LED Load}$

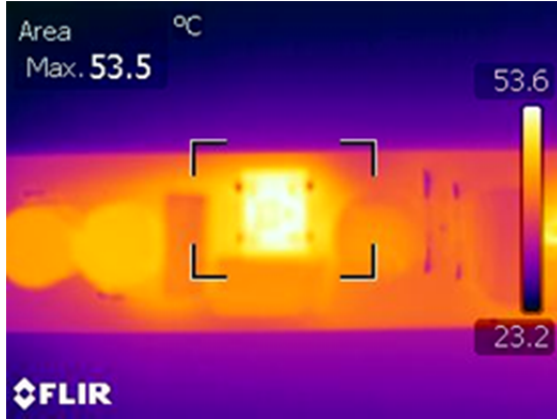

Figure 18 – Input Area. 115 VAC, 60 Hz.

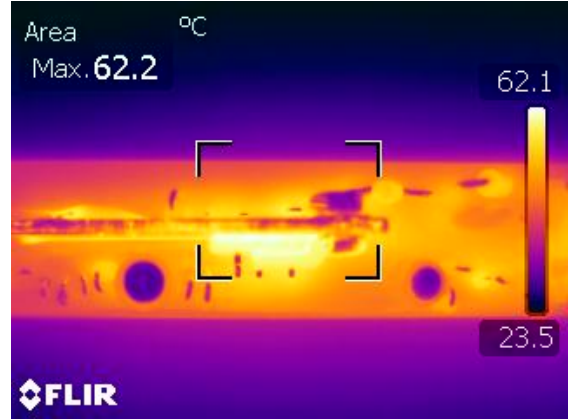

Figure 19 – LYT4215E Area. 115 VAC, 60 Hz.

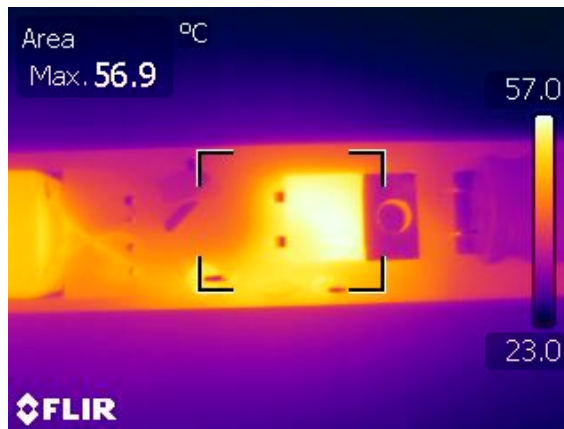

Figure 20 – Transformer and Output Area. 115 VAC, 60 Hz.



13 Waveforms

13.1 Input Voltage and Input Current Waveforms

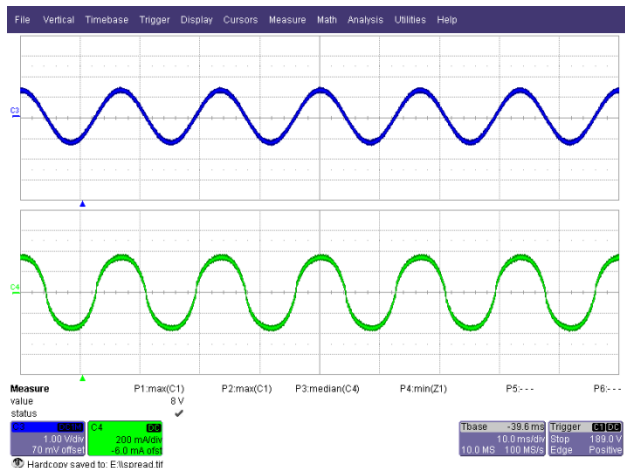

Figure 21 – 90 VAC, Full Load.
 Upper: V_{IN} , 100 V / div.
 Lower: I_{IN} , 200 mA, 10 ms / div.

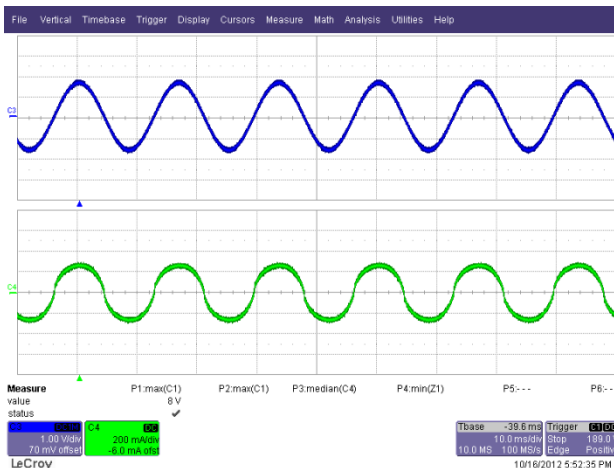

Figure 22 – 115 VAC, Full Load.
 Upper: V_{IN} , 100 V / div.
 Lower: I_{IN} , 200 mA, 10 ms / div.

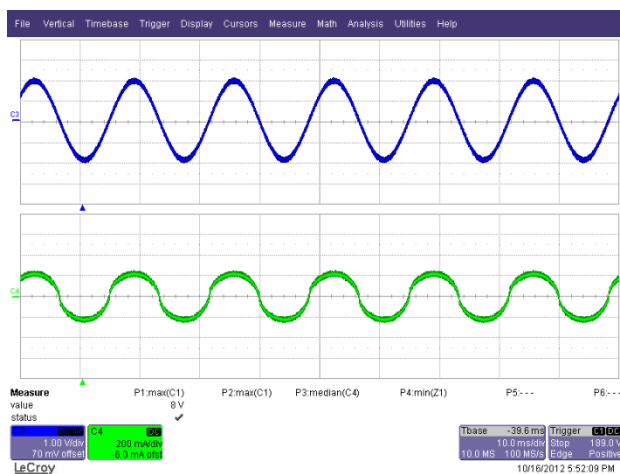

Figure 23 – 135 VAC, Full Load.
 Upper: V_{IN} , 100 V / div.
 Lower: I_{IN} , 200 mA, 10 ms / div.



13.2 Output Voltage and Output Current Waveforms

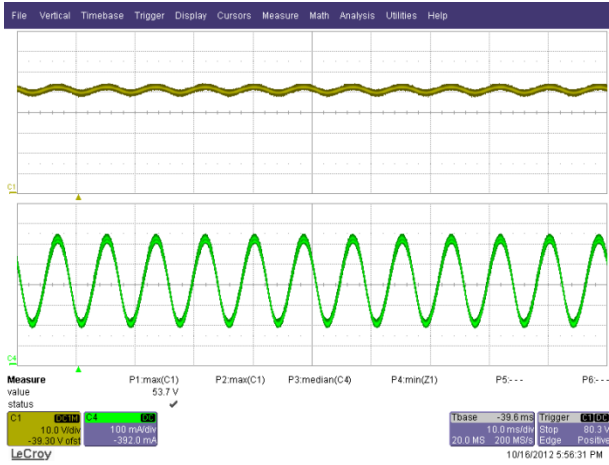

Figure 24 – 90 VAC, 60 Hz Full Load.
 Upper: V_{OUT} , 10 V / div.
 Lower: I_{OUT} , 100 mA, 10 ms / div.

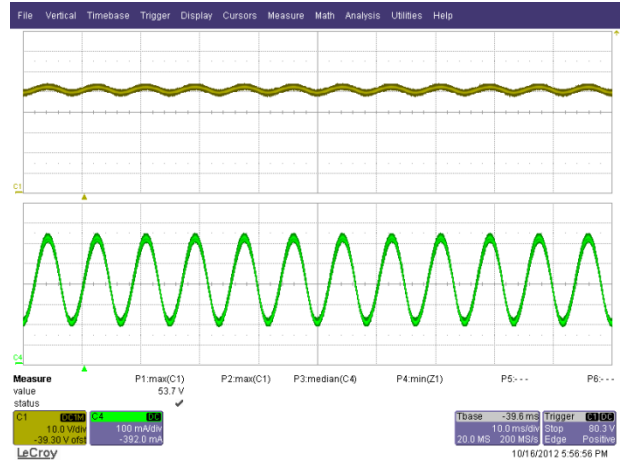

Figure 25 – 115 VAC, 60 Hz Full Load.
 Upper: V_{OUT} , 10 V / div.
 Lower: I_{OUT} , 100 mA, 10 ms / div.

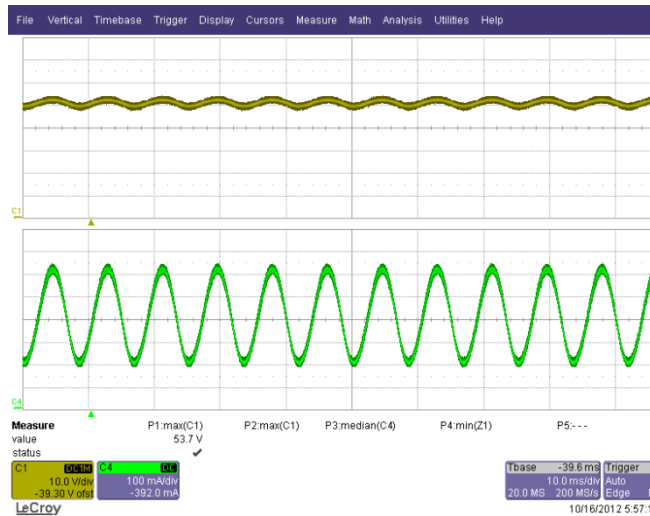

Figure 26 – 135 VAC, 60 Hz Full Load.
 Upper: V_{OUT} , 10 V / div.
 Lower: I_{OUT} , 100 mA, 10 ms / div.



13.3 Output Voltage and Output Current Waveforms at Start-up

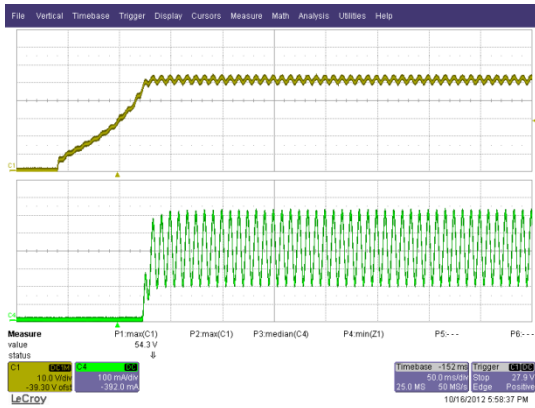

Figure 27 – 90 VAC Output Rise.
 Upper: V_{OUT} , 10 V / div.
 Lower: I_{OUT} , 100 mA, 50 ms / div.

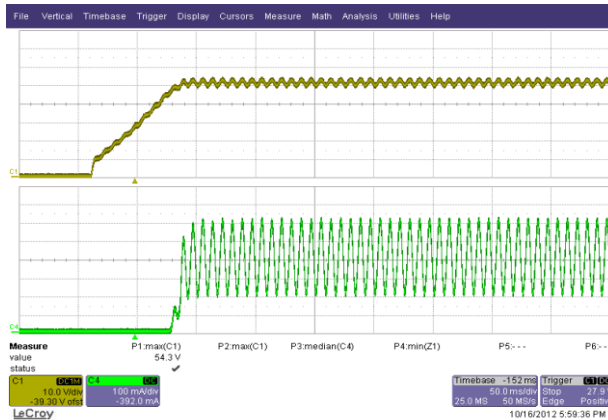

Figure 28 – 135 VAC Output Fall.
 Upper: V_{OUT} , 10 V / div.
 Lower: I_{OUT} , 100 mA, 100 ms / div.

13.4 Drain Voltage and Current Waveforms at Start-up

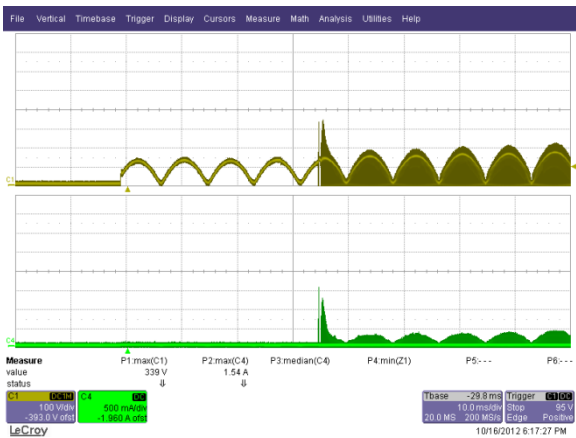

Figure 29 – 90 VAC, 60 Hz Start-up.
 Upper: V_{DRAIN} , 100 V / div.
 Lower: I_{DRAIN} , 500 mA, 10 ms / div.

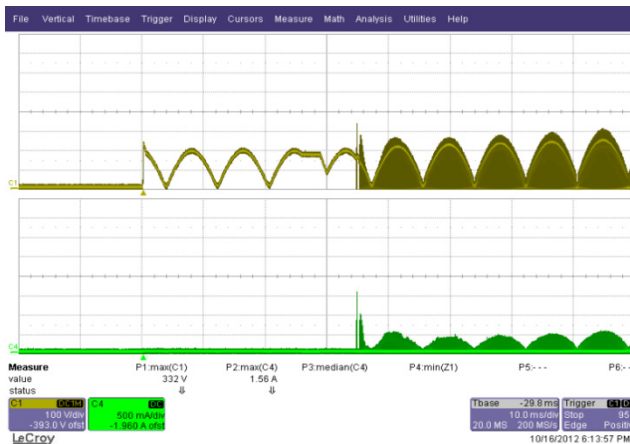

Figure 30 – 135 VAC, 60 Hz Start-up.
 Upper: V_{DRAIN} , 100 V / div.
 Lower: I_{DRAIN} , 500 mA, 10 ms / div.



13.5 Input Voltage and Output Current Waveforms at Start-up

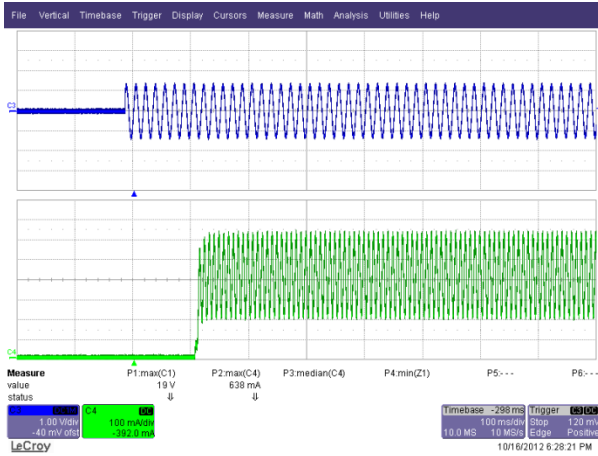

Figure 31 – 90 VAC, 60 Hz.
 Upper: V_{IN} , 100 V / div.
 Lower: I_{OUT} , 100 mA, 100 ms / div.

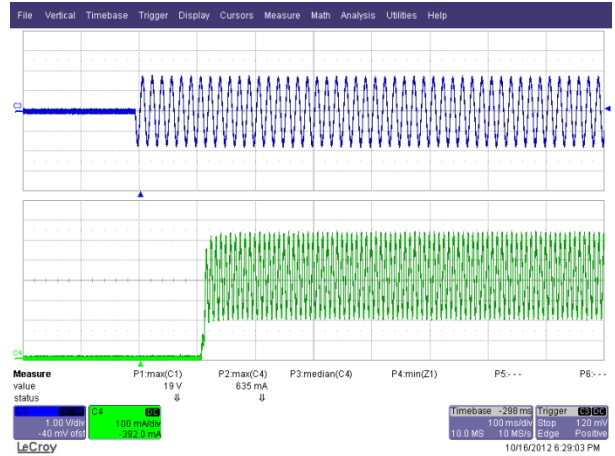

Figure 32 – 115 VAC, 60 Hz.
 Upper: V_{IN} , 100 V / div.
 Lower: I_{OUT} , 100 mA, 100 ms / div.

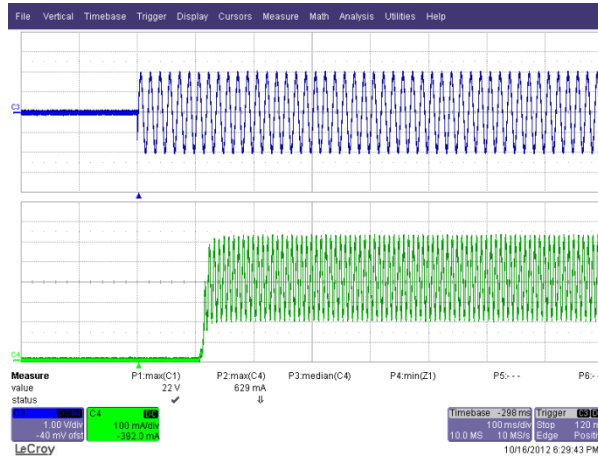

Figure 33 – 135 VAC, 60 Hz.
 Upper: V_{IN} , 100 V / div.
 Lower: I_{OUT} , 100 mA, 100 ms / div.



13.6 Drain Voltage and Current Waveforms

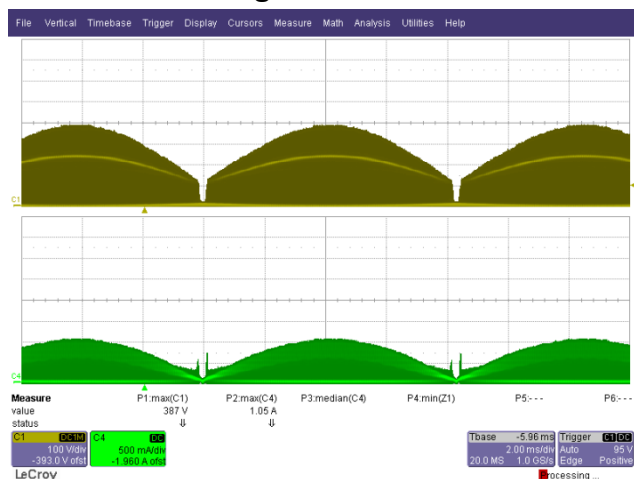

Figure 34 – 90 VAC, 60 Hz.
 Upper: V_{DRAIN} , 100 V / div.
 Lower: I_{DRAIN} , 500 mA, 2 ms / div.

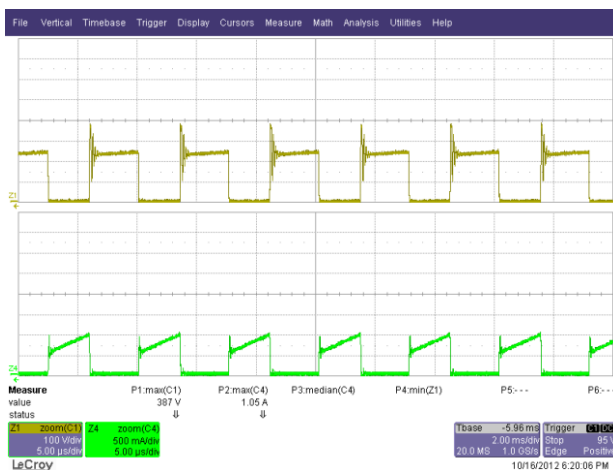

Figure 35 – 90 VAC, 60 Hz.
 Upper: V_{DRAIN} , 100 V / div.
 Lower: I_{DRAIN} , 500 mA, 5 μ s / div.

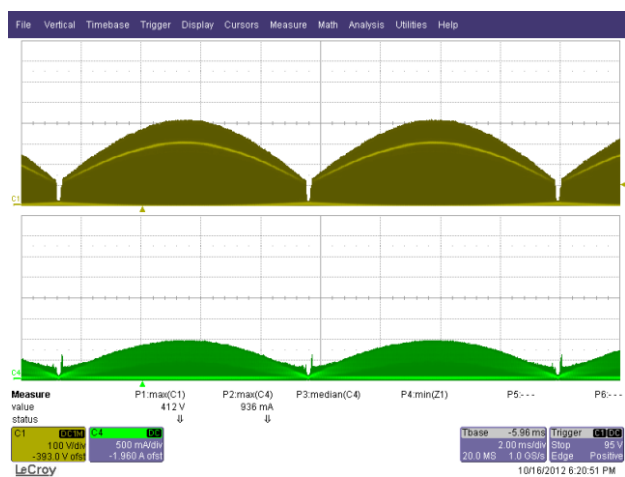

Figure 36 – 135 VAC, 60 Hz.
 Upper: V_{DRAIN} , 100 V / div.
 Lower: I_{DRAIN} , 500 mA, 2 ms / div.

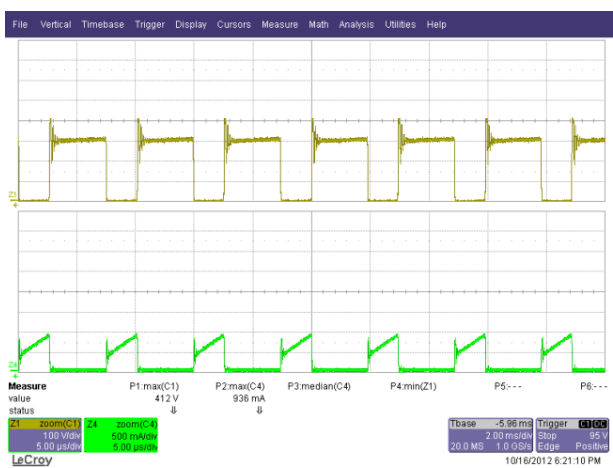

Figure 37 – 135 VAC, 60 Hz.
 Upper: V_{DRAIN} , 100 V / div.
 Lower: I_{DRAIN} , 500 mA, 5 μ s / div.



13.7 Output Short Condition

During output short condition, the I_{FB} current falls below the $I_{FB(AR)}$ threshold and enters the auto-restart condition. During this condition, to minimize power dissipation on the power components, the auto-restart circuit turns the power supply on and off at an auto-restart duty cycle of typically DC_{AR} for as long as the fault condition persists.

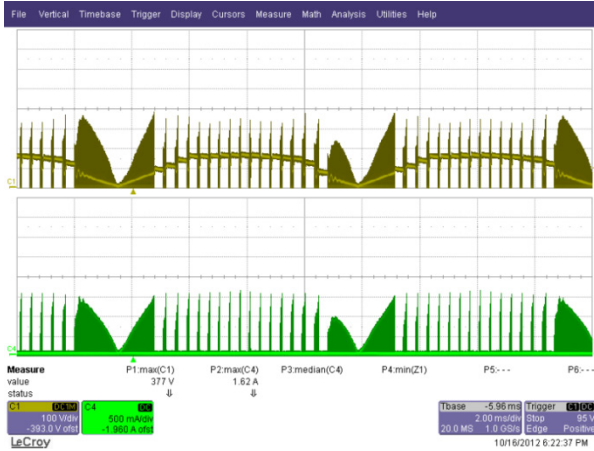

Figure 38 – 90 VAC, 60 Hz Output Short Condition.
Upper: V_{DRAIN} , 100 V / div.
Lower: I_{DRAIN} , 500 mA, 2 ms / div.

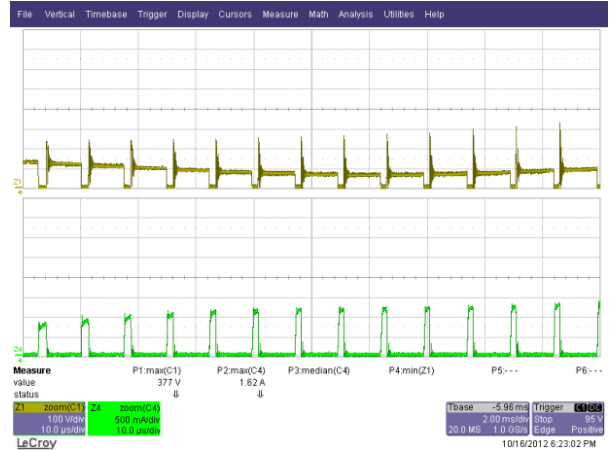

Figure 39 – 90 VAC, 60 Hz Output Short Condition.
Upper: V_{DRAIN} , 100 V / div.
Lower: I_{DRAIN} , 500 mA, 10 μ s / div.



Figure 40 – 135 VAC, 60 Hz Output Short Condition.
Upper: V_{DRAIN} , 100 V / div.
Lower: I_{DRAIN} , 500 mA, 2 ms / div.

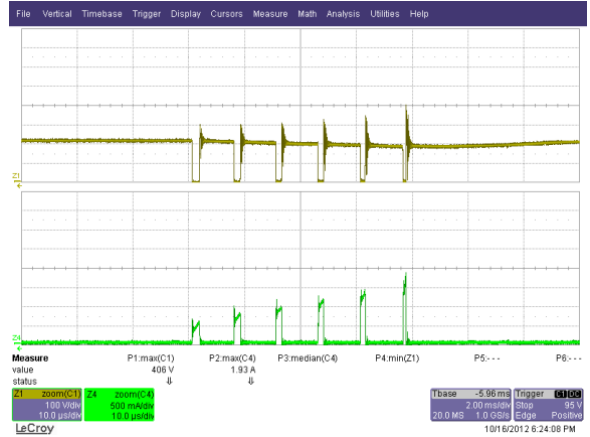

Figure 41 – 135 VAC, 60 Hz Output Short Condition.
Upper: V_{DRAIN} , 100 V / div.
Lower: I_{DRAIN} , 500 mA, 10 μ s / div.



13.8 Output Diode Voltage and Current Waveforms

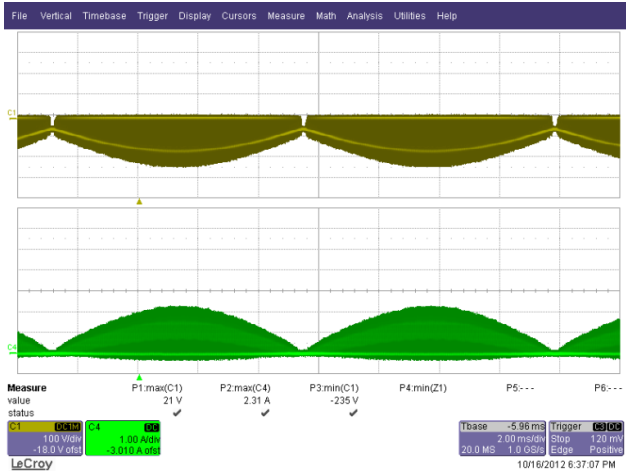

Figure 42 – 135 VAC, 60 Hz Normal Operation.
 Upper: V_{DRAIN} , 100 V / div.
 Lower: I_{DRAIN} , 1 A, 2 ms / div.

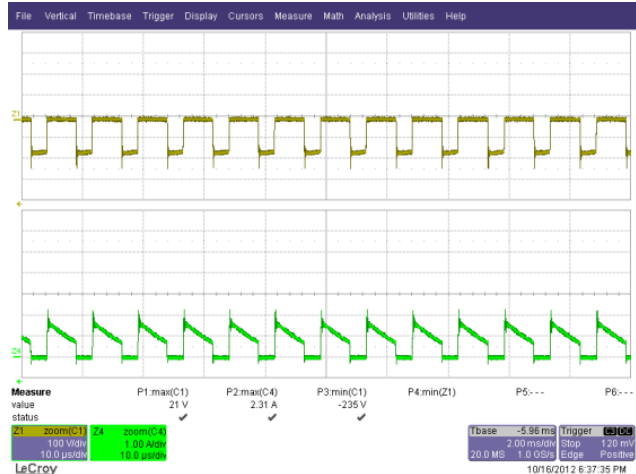

Figure 43– 135 VAC, 60 Hz Output Short.
 Upper: V_{DRAIN} , 100 V / div.
 Lower: I_{DRAIN} , 1 A, 10 μ s / div.

13.9 Output Voltage Waveforms at Open Load

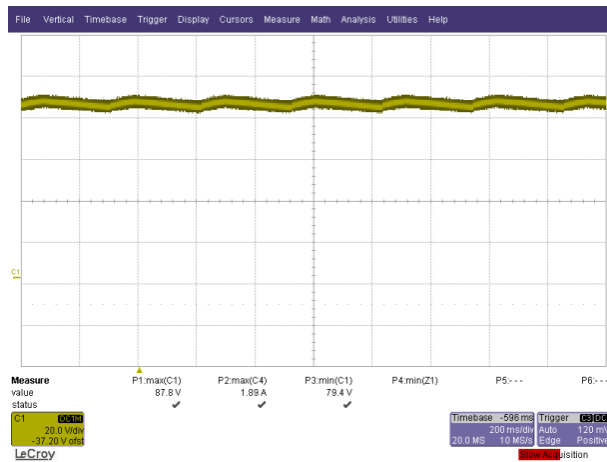

Figure 44 – 135 VAC, 60 Hz Output Open.
 V_{OUT} , 20 V / div., 200 ms/div.



14 Conducted EMI

25.Oct 12 17:00

MT

500 ms

Att 10 dB AUTO

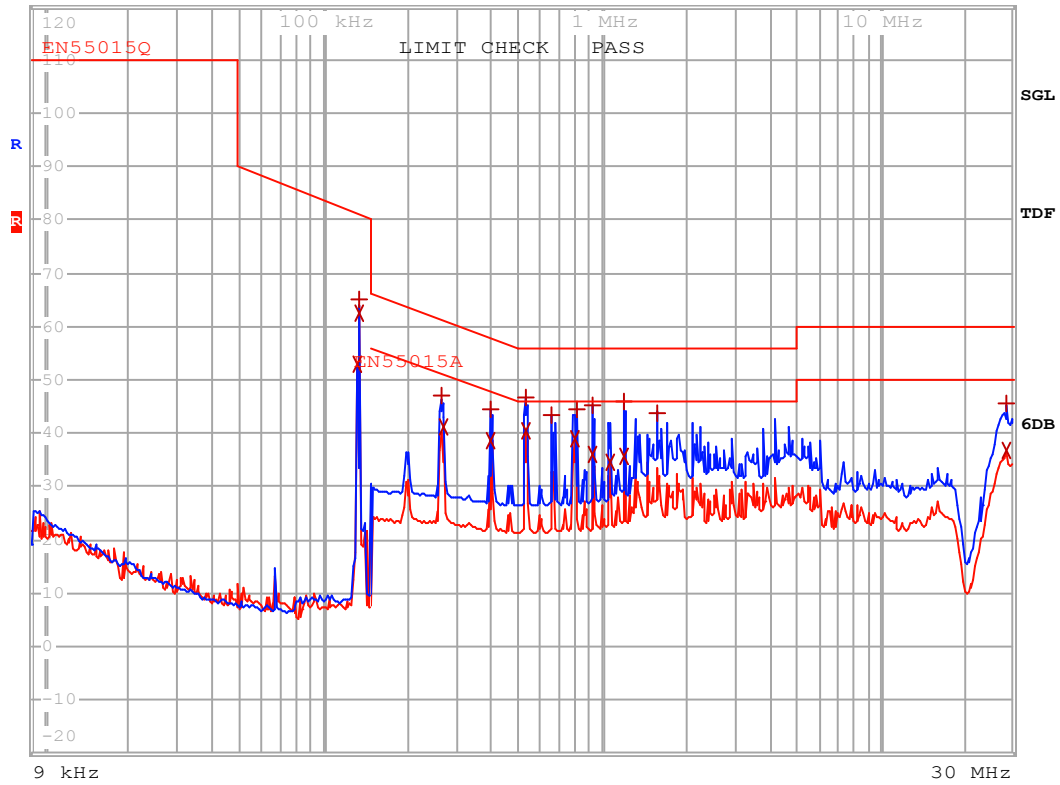

EDIT PEAK LIST (Final Measurement Results)

Trace1: EN55015Q
Trace2: EN55015A
Trace3: ---

TRACE	FREQUENCY	LEVEL dBµV	DELTA	LIMIT dB
2 Average	130.825395691 kHz	52.82	N gnd	
1 Quasi Peak	133.454986145 kHz	65.04	L1 gnd	-16.02
2 Average	133.454986145 kHz	62.52	N gnd	
1 Quasi Peak	264.49018761 kHz	46.89	N gnd	-14.39
2 Average	267.135089486 kHz	41.33	N gnd	-9.87
1 Quasi Peak	397.727746704 kHz	44.56	L1 gnd	-13.33
2 Average	397.727746704 kHz	38.71	L1 gnd	-9.18
1 Quasi Peak	530.769219795 kHz	46.74	L1 gnd	-9.25
2 Average	530.769219795 kHz	40.27	L1 gnd	-5.73
1 Quasi Peak	660.656865747 kHz	43.25	L1 gnd	-12.74
2 Average	798.145472681 kHz	39.12	L1 gnd	-6.87
1 Quasi Peak	806.126927408 kHz	44.44	L1 gnd	-11.56
1 Quasi Peak	926.622115652 kHz	45.15	L1 gnd	-10.84
2 Average	926.622115652 kHz	36.01	L1 gnd	-9.98
2 Average	1.06512822736 MHz	34.60	L1 gnd	-11.39
1 Quasi Peak	1.1883298484 MHz	45.90	L1 gnd	-10.09
2 Average	1.20021314689 MHz	35.59	L1 gnd	-10.40
1 Quasi Peak	1.58583078933 MHz	43.89	L1 gnd	-12.10
1 Quasi Peak	28.4089539309 MHz	45.60	N gnd	-14.39
2 Average	28.4089539309 MHz	36.59	L1 gnd	-13.40

Figure 45 – Conducted EMI, 50 V LED Load, 115 VAC, 60 Hz and EN55015 B Limits.



15 Line Surge

The unit was subjected to 2500 V ring wave and 1000 V differential surge at 115 VAC using 10 strikes at each condition. A test failure was defined as a non-recoverable interruption of output requiring supply repair or recycling of input voltage.

Level (V)	Input Voltage (VAC)	Injection Location	Injection Phase (°)	Type	Test Result (Pass/Fail)
+2500	115	L1, L2	0	100 kHz Ring Wave (500 A)	Pass
-2500	115	L1, L2	0	100 kHz Ring Wave (500 A)	Pass
+2500	115	L1, L2	90	100 kHz Ring Wave (500 A)	Pass
-2500	115	L1, L2	90	100 kHz Ring Wave (500 A)	Pass

Level (V)	Input Voltage (VAC)	Injection Location	Injection Phase (°)	Type	Test Result (Pass/Fail)
+1000	115	L1, L2	0	Surge (2Ω)	Pass
-1000	115	L1, L2	0	Surge (2Ω)	Pass
+1000	115	L1, L2	90	Surge (2Ω)	Pass
-1000	115	L1, L2	90	Surge (2Ω)	Pass

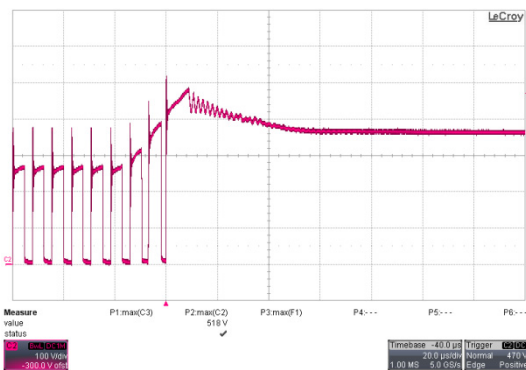

Figure 46 – +1 kV Differential Surge, 90°
 V_{DRAIN} , 100 V / div., 20 μs / div.

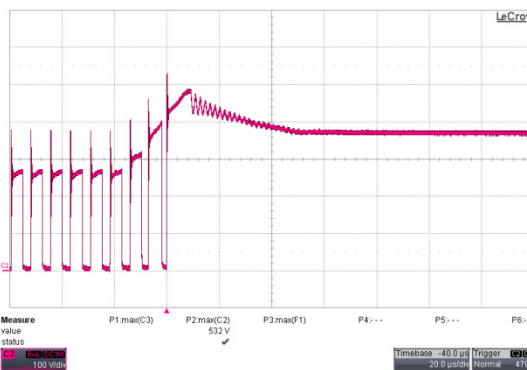

Figure 47 – -1 kV Differential Surge, 90°
 V_{DRAIN} , 100 V / div., 20 μs / div.



16 Revision History

Date	Author	Revision	Description and Changes	Reviewed
29-Jan-13	DK	1.0	Initial Release	Apps & Mktg



For the latest updates, visit our website: www.powerint.com

Power Integrations reserves the right to make changes to its products at any time to improve reliability or manufacturability. Power Integrations does not assume any liability arising from the use of any device or circuit described herein. POWER INTEGRATIONS MAKES NO WARRANTY HEREIN AND SPECIFICALLY DISCLAIMS ALL WARRANTIES INCLUDING, WITHOUT LIMITATION, THE IMPLIED WARRANTIES OF MERCHANTABILITY, FITNESS FOR A PARTICULAR PURPOSE, AND NON-INFRINGEMENT OF THIRD PARTY RIGHTS.

PATENT INFORMATION

The products and applications illustrated herein (including transformer construction and circuits' external to the products) may be covered by one or more U.S. and foreign patents, or potentially by pending U.S. and foreign patent applications assigned to Power Integrations. A complete list of Power Integrations' patents may be found at www.powerint.com. Power Integrations grants its customers a license under certain patent rights as set forth at <http://www.powerint.com/ip.htm>.

The PI Logo, TOPSwitch, TinySwitch, LinkSwitch, LYTSwitch, DPA-Switch, PeakSwitch, CAPZero, SENZero, LinkZero, HiperPFS, HiperTFS, HiperLCS, Qspeed, EcoSmart, Clampless, E-Shield, Filterfuse, StackFET, PI Expert and PI FACTS are trademarks of Power Integrations, Inc. Other trademarks are property of their respective companies. ©Copyright 2012 Power Integrations, Inc.

Power Integrations Worldwide Sales Support Locations

WORLD HEADQUARTERS

5245 Hellyer Avenue
San Jose, CA 95138, USA.
Main: +1-408-414-9200
Customer Service:
Phone: +1-408-414-9665
Fax: +1-408-414-9765
e-mail: usasales@powerint.com

GERMANY

Lindwurmstrasse 114
80337, Munich
Germany
Phone: +49-895-527-39110
Fax: +49-895-527-39200
e-mail:
eurosales@powerint.com

JAPAN

Kosei Dai-3 Building
2-12-11, Shin-Yokohama,
Kohoku-ku, Yokohama-shi,
Kanagawa 222-0033
Japan
Phone: +81-45-471-1021
Fax: +81-45-471-3717
e-mail: japansales@powerint.com

TAIWAN

5F, No. 318, Nei Hu Rd.,
Sec. 1
Nei Hu District
Taipei 11493, Taiwan R.O.C.
Phone: +886-2-2659-4570
Fax: +886-2-2659-4550
e-mail:
taiwansales@powerint.com

CHINA (SHANGHAI)

Rm 1601/1610, Tower 1,
Kerry Everbright City
No. 218 Tianmu Road West,
Shanghai, P.R.C. 200070
Phone: +86-21-6354-6323
Fax: +86-21-6354-6325
e-mail: chinasales@powerint.com

INDIA

#1, 14th Main Road
Vasanthanagar
Bangalore-560052
India
Phone: +91-80-4113-8020
Fax: +91-80-4113-8023
e-mail:
indiasales@powerint.com

KOREA

RM 602, 6FL
Korea City Air Terminal B/D,
159-6
Samsung-Dong, Kangnam-Gu,
Seoul, 135-728 Korea
Phone: +82-2-2016-6610
Fax: +82-2-2016-6630
e-mail: koreasales@powerint.com

EUROPE HQ

1st Floor, St. James's House
East Street, Farnham
Surrey GU9 7TJ
United Kingdom
Phone: +44 (0) 1252-730-141
Fax: +44 (0) 1252-727-689
e-mail:
eurosales@powerint.com

CHINA (SHENZHEN)

3rd Floor, Block A,
Zhongtuo International Business
Center, No. 1061, Xiang Mei Rd,
FuTian District, ShenZhen,
China, 518040
Phone: +86-755-8379-3243
Fax: +86-755-8379-5828
e-mail: chinasales@powerint.com

ITALY

Via Milanese 20, 3rd. Fl.
20099 Sesto San Giovanni
(MI) Italy
Phone: +39-024-550-8701
Fax: +39-028-928-6009
e-mail:
eurosales@powerint.com

SINGAPORE

51 Newton Road,
#19-01/05 Goldhill Plaza
Singapore, 308900
Phone: +65-6358-2160
Fax: +65-6358-2015
e-mail:
singaporesales@powerint.com

APPLICATIONS HOTLINE

World Wide +1-408-414-9660

APPLICATIONS FAX

World Wide +1-408-414-9760

