

General Description

The TD9516/TD9517/TD9518/TD9519 series of power switches are designed for USB applications. The 62mΩ N-channel MOSFET power switch satisfies the voltage drop requirements of USB specification. The protection features include current-limit protection, short-circuit protection, and over-temperature protection. The device limits the output current at current limit threshold level. When V_{out} drops below 1.5V, the devices limit the current to a lower and safe level. The over-temperature protection limits the junction temperature below 140°C in case of short circuit or over load conditions. Other features include a deglitched OCB output to indicate the fault condition and an enable input to enable or disable the device.

Features

- 62mΩ High Side MOSFET
- Wide Supply Voltage Range: 2.7V to 5.5V
- Current-Limit and Short-Circuit Protections
- Over-Temperature Protection
- Fault Indication Output
- Enable Input
- Lead Free and Green Devices Available

Applications

- Notebook and Desktop Computers
- USB Ports
- High-Side Power Protection Switches

Pin Configurations

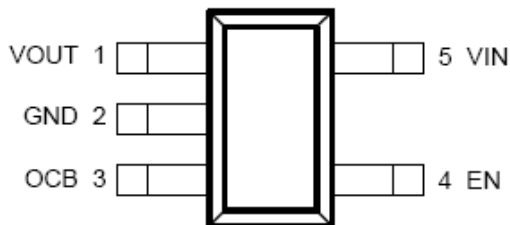

SOT-23-5(Top View)
TD9516A/TD9517A

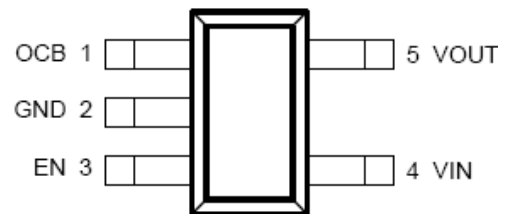

SOT-23-5(Top View)
TD9518A/TD9519A

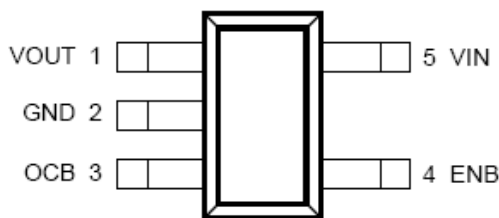

SOT-23-5(Top View)
TD9516B/TD9517B

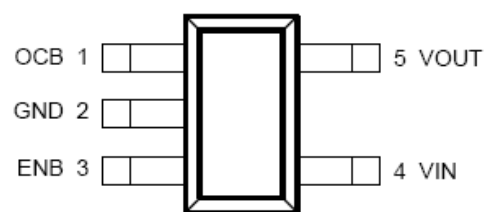

SOT-23-5(Top View)
TD9518B/TD9519B

Figure Pin Configuration of TD9516/TD9517/TD9518/TD9519(Top View)

Pin Description

Pin Number		Pin Name	Description
TD9516/ TD9517	TD9518/ TD9519		
1	5	VOUT	Output Voltage Pin. The output voltage follows the input voltage. When ENB is high or EN is low, the output voltage is discharged by an internal resistor.
2	2	GND	Ground.
3	1	OCB	Fault Indication Pin. This pin goes low when a current limit or an over-temperature condition is detected after a 12ms deglitch time.
4	3	EN	Enable Input. Pulling this pin to high will enable the device and pulling this pin to low will disable device. The EN pin cannot be left floating.
		ENB	Enable Input. Pulling this pin to high will enable the device and pulling this pin to low will disable device. The EN pin cannot be left floating.
5	4	VIN	Power Supply Input. Connect this pin to external DC supply.

Ordering Information

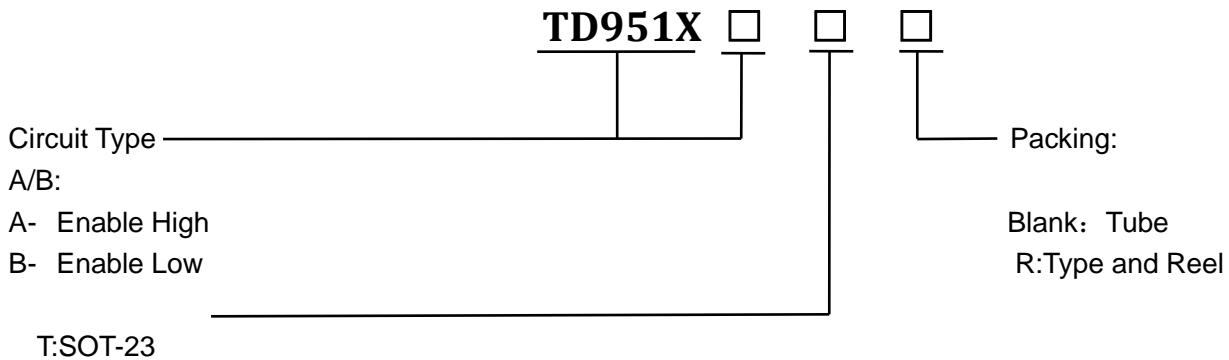

Functional Block Diagram

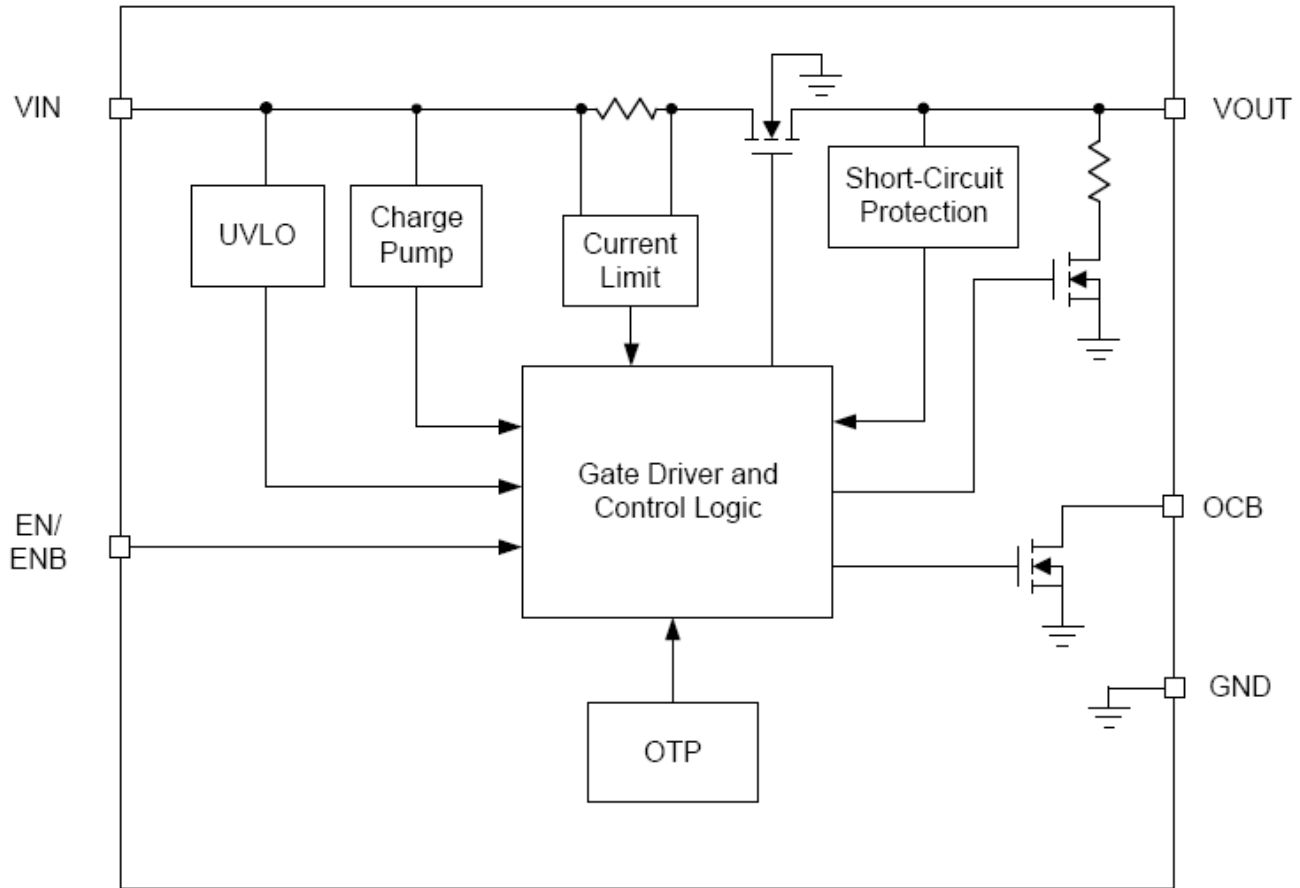

Absolute Maximum Ratings

Symbol	Parameter	Rating	Unit
V_{IN}	V_{IN} Input Voltage (V_{IN} to GND)	-0.3 ~ 7	V
V_{OUT}	V_{OUT} to GND Voltage	-0.3 ~ 7	V
V_{ENB}, V_{EN}	EN, ENB to GND Voltage	-0.3 ~ 7	V
V_{OCB}	OCB to GND Voltage	-0.3 ~ 7	V
T_J	Maximum Junction Temperature	150	°C
T_{STG}	Storage Temperature	-65 ~ 150	°C
T_{SDR}	Maximum Soldering Temperature, 10 Seconds	260	°C

Note 1: Absolute Maximum Ratings are those values beyond which the life of a device may be impaired. Exposure to absolute maximum rating conditions for extended periods may affect device reliability.

Recommended Operating Conditions

Symbol	Parameter	Range	Unit
V _{IN}	VIN Input Voltage	2.7~5.5	V
VCC	VCC Supply Voltage	4.5 ~ 5.5	V
I _{OUT}	OUT Output Current (TD9516/TD9518)	0~1	A
	OUT Output Current (TD9517/TD9519)	0~ 2	A
T _A	Ambient Temperature	-40 ~ 85	°C
T _J	Junction Temperature	-40 ~ 125	°C

Note: Refer to the typical application circuit.

Thermal Characteristics

Symbol	Parameter	Typical Value	Unit
θ _{JA}	Junction-to-Ambient Resistance in Free Air	235	°C/W

Electrical Characteristics

Unless otherwise specified, these specifications apply over $V_{IN}=5V$, $V_{EN}=5V$ or $V_{ENB}=0V$ and $T_A=-40 \sim 85 \text{ }^\circ\text{C}$. Typical values are at $T_A=25 \text{ }^\circ\text{C}$.

Symbol	Parameter	Test Conditions				Unit
			Min.	Typ.	Max.	
SUPPLY CURRENT						
	VIN Supply Current	No load, $V_{EN}=0V$ or $V_{ENB}=5V$	–	–	1	μA
		No load, $V_{EN}=5V$ or $V_{ENB}=0V$		60	100	μA
	Leakage Current	$V_{OUT}=\text{GND}$, $V_{EN}=0V$ or $V_{ENB}=5V$	–	–	1	μA
	Reverse Leakage Current	$V_{IN}=\text{GND}$, $V_{OUT}=5V$, $V_{EN}=0V$ or $V_{ENB}=5V$	–	–	1	μA
POWER SWITCH						
$R_{DS(ON)}$	Power Switch On Resistance	$I_{OUT}=1A$, $T_A=25 \text{ }^\circ\text{C}$		62	78	$\text{m}\Omega$
UNDER-VOLTAGE LOCKOUT (UVLO)						
	VIN UVLO Threshold Voltage	V_{IN} rising, $T_A=-40 \sim 85 \text{ }^\circ\text{C}$	1.7		2.65	V
	VIN UVLO Hysteresis			0.2		V
CURRENT-LIMIT AND SHORT-CIRCUIT PROTECTIONS						
I_{LIM}	Current Limit Threshold	TD9517/TD9519 $V_{IN}=2.7V$ to $5.5V$, $T_A=-40 \sim 85 \text{ }^\circ\text{C}$	2.1	2.5	3.6	A
		TD9516/TD9518 $V_{IN}=2.7V$ to $5.5V$, $T_A=-40 \sim 85 \text{ }^\circ\text{C}$	1.1	1.5	2.1	A
I_{SHORT}	Short-Circuit Output Current	TD9517/TD9519, $V_{IN}=2.7V$ to $5.5V$		1.5		A
		TD9516/TD9518, $V_{IN}=2.7V$ to $5.5V$		0.8		A
OCB OUTPUT PIN						
	OCB Output Low Voltage	$I_{OCB}=5\text{mA}$		0.2	0.4	V
	OCB Leakage Current	$V_{OCB}=5V$			1	μA
$t_{D(OCB)}$	OCB Deglitch Time	OCB assertion, $T_A=-40 \sim 85 \text{ }^\circ\text{C}$	5	12	20	mS
EN OR ENB INPUT PIN						
V_{IH}	Input Logic HIGH	$V_{IN}=2.7V$ to $5V$	2			V
V_{IL}	Input Logic LOW	$V_{IN}=2.7V$ to $5V$			0.8	V
	Input Current				1	μA
	VOUT Discharge Resistance	$V_{EN}=0V$ or $V_{ENB}=5V$, $V_{OUT}=1V$		40		Ω
$t_{D(ON)}$	Turn On Delay Time			30		μS
$t_{D(OFF)}$	Turn Off Delay Time			30		μS
t_{SS}	Soft-Start Time	No load, $C_{OUT}=1\mu\text{F}$, $V_{IN}=5V$		400		μS
OVER-TEMPERATURE PROTECTION (OTP)						
T_{OTP}	Over-Temperature Threshold	T_J rising		140		$^\circ\text{C}$
	Over-Temperature Hysteresis			20		$^\circ\text{C}$

Typical Operating Characteristics

Switch On Resistance vs. Ambient Temperature

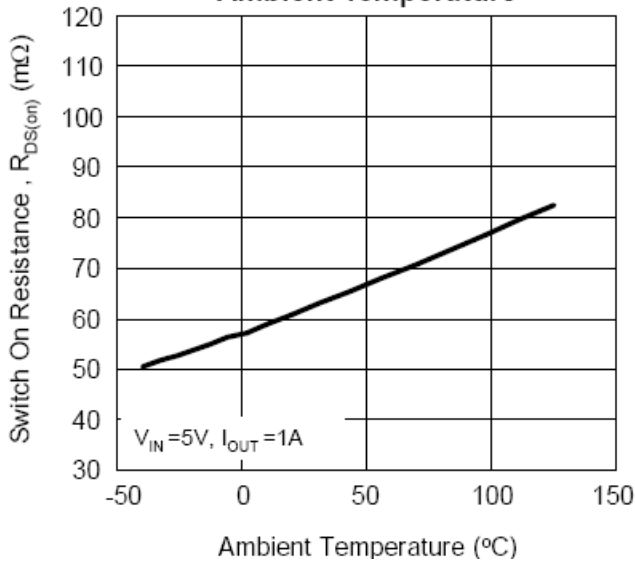

Switch On Resistance vs. Input Voltage

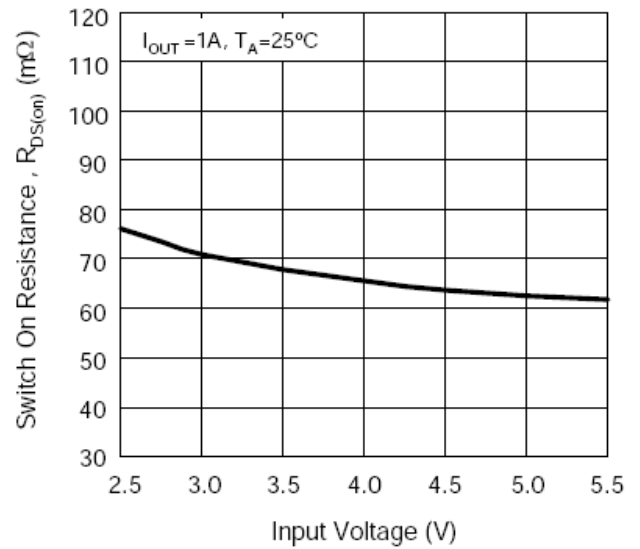

Supply Current vs. Junction Temperature

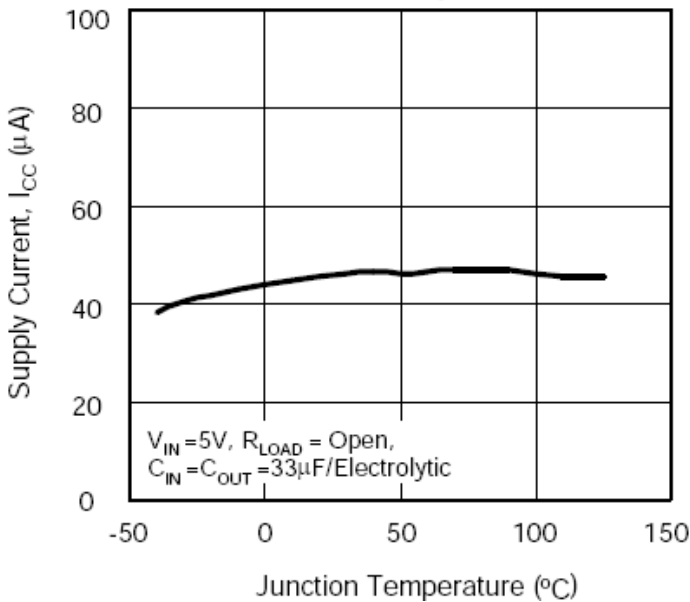

Supply Current vs. Input Voltage

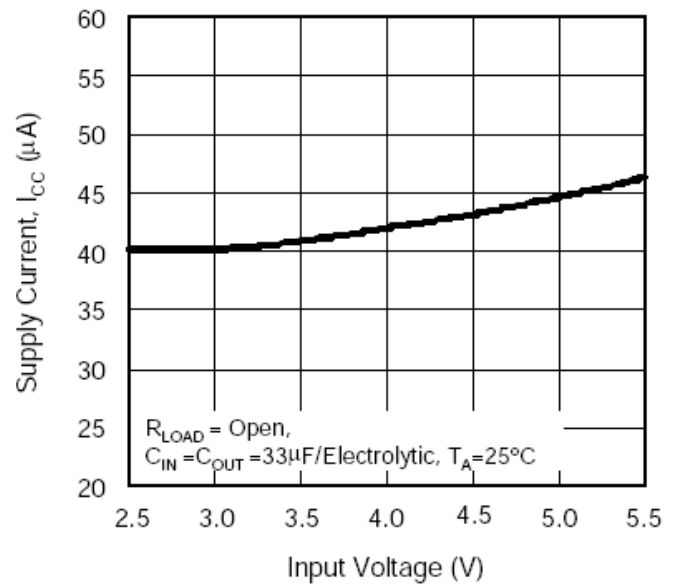

Typical Operating Characteristics(Cont.)

Current Limit Threshold vs. Junction Temperature

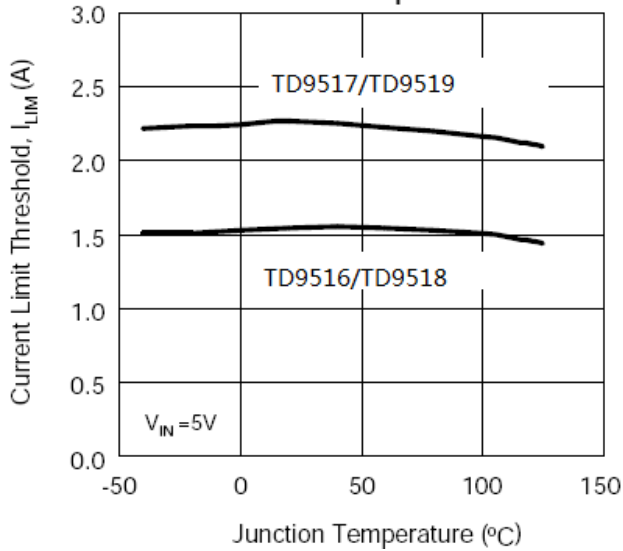

Current Limit Threshold vs. Input Voltage

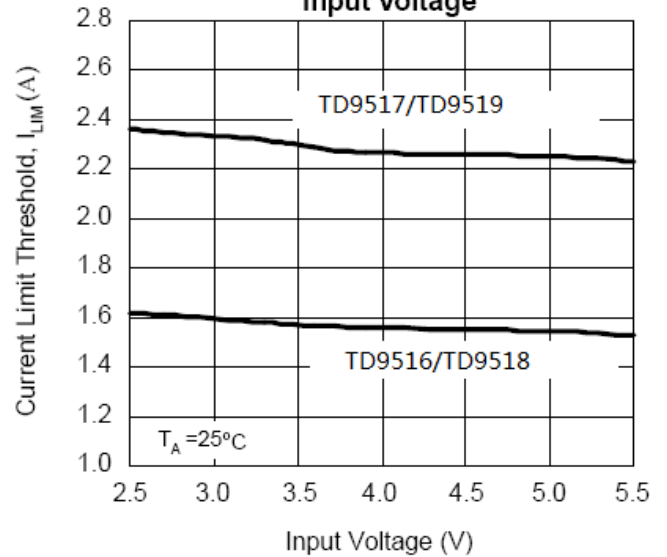

Current-Limit Response vs. Output Peak Current

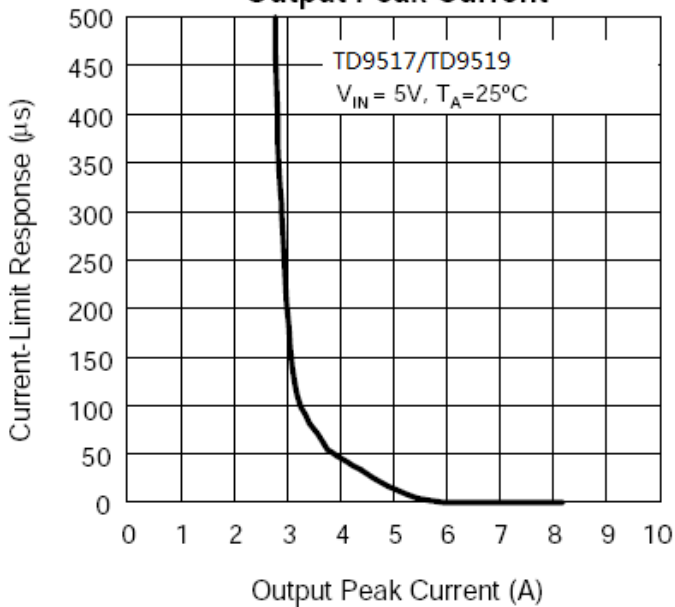

Current-Limit Response vs. Output Peak Current

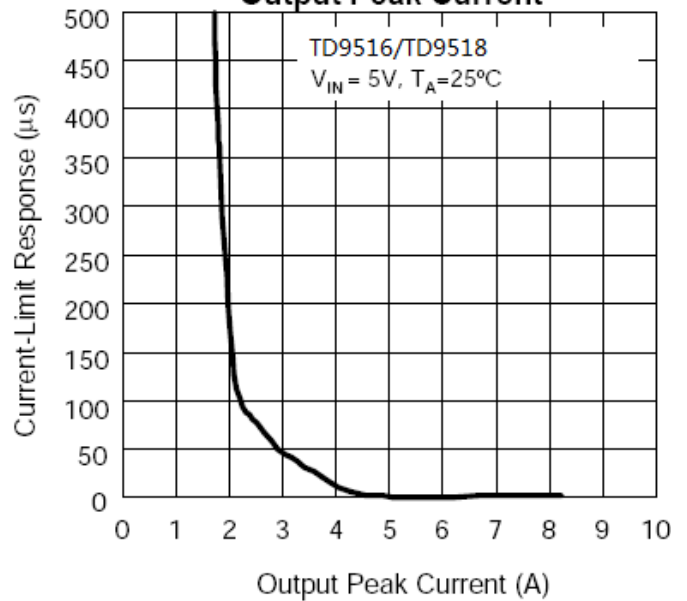

Typical Operating Characteristics(Cont.)

Short-Circuit Output Current vs. Input Voltage

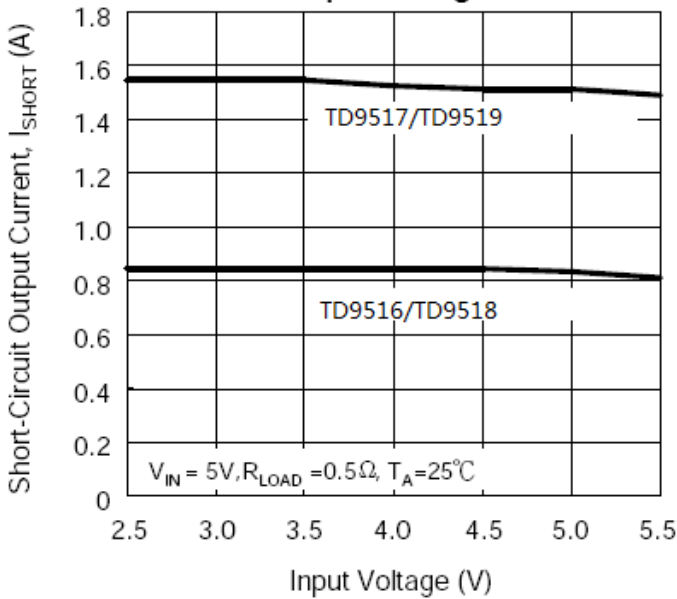

EN pin Threshold Voltage vs. Junction Temperature

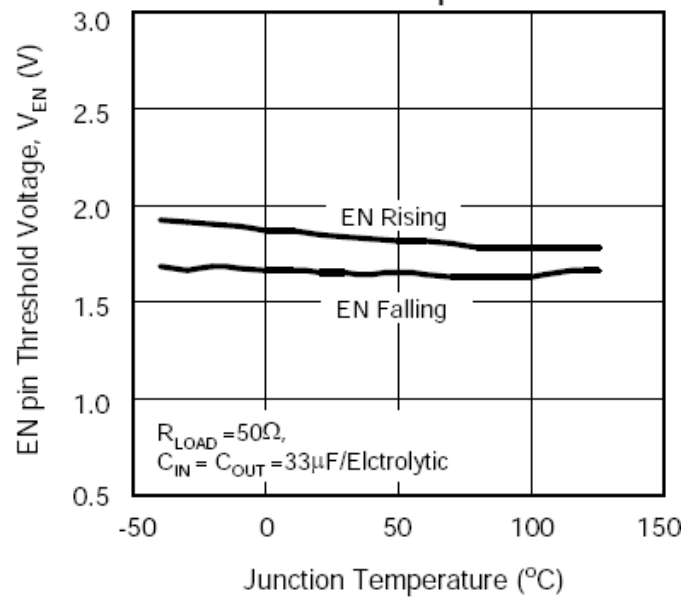

EN pin Threshold Voltage vs. Input Voltage

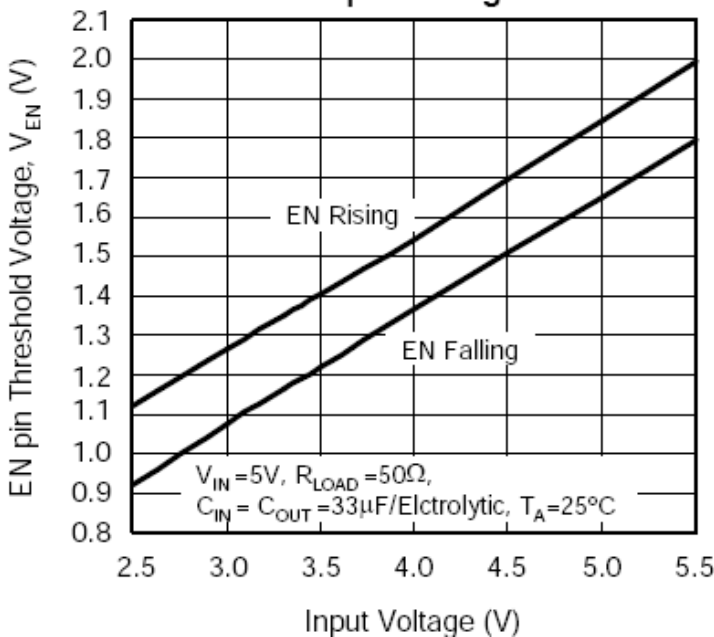

Turn-Off Leakage Current vs. Junction Temperature

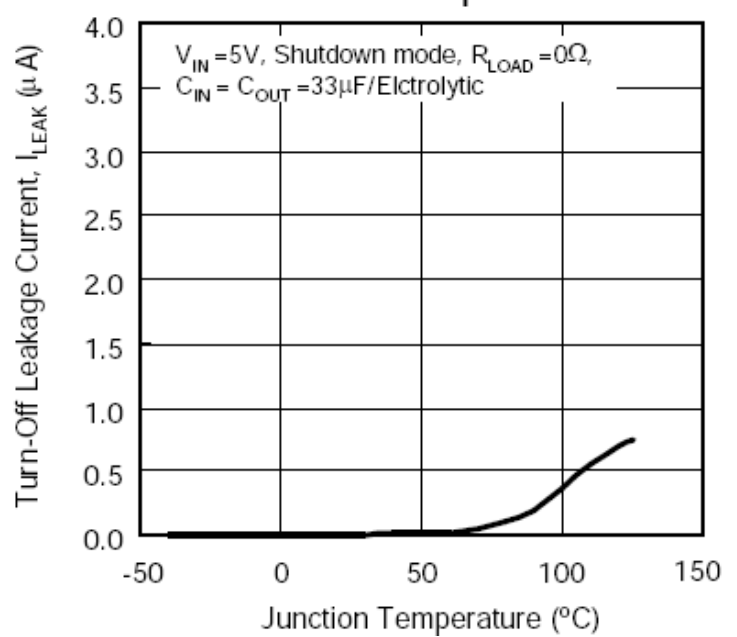

Typical Operating Characteristics(Cont.)

OCB Deglitch Time vs. Junction Temperature

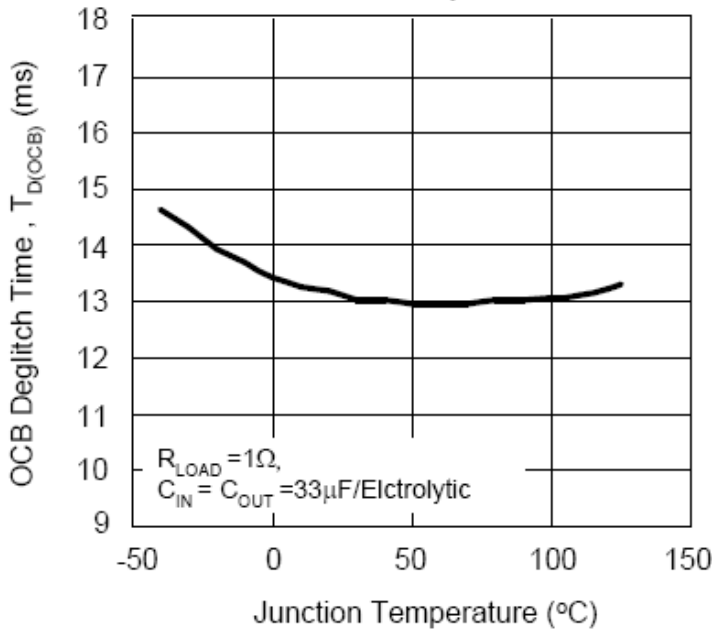

OCB Deglitch Time vs. Input Voltage

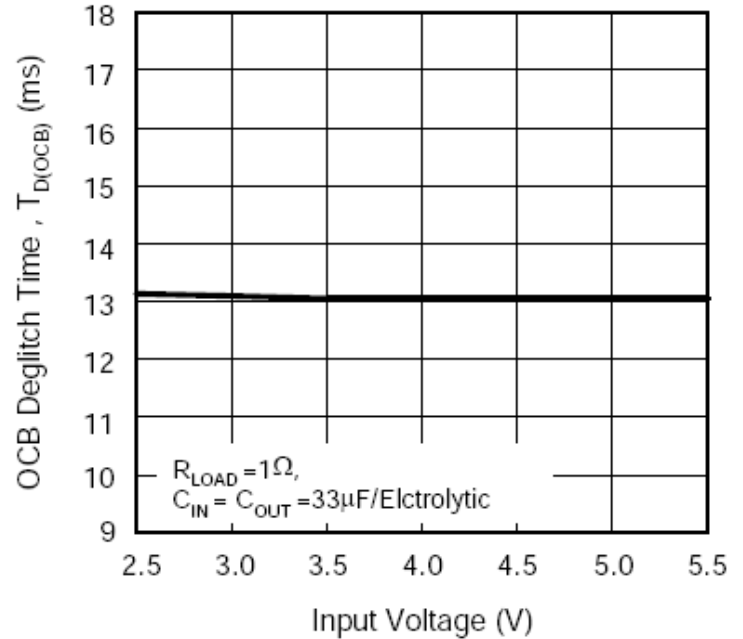

UVLO Threshold Voltage vs. Junction Temperature

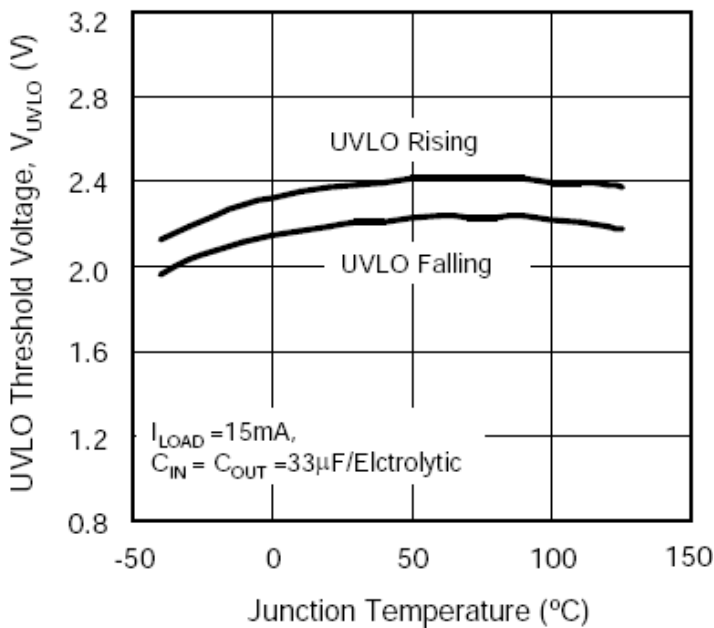

Turn-Off Falling Time vs. Junction Temperature

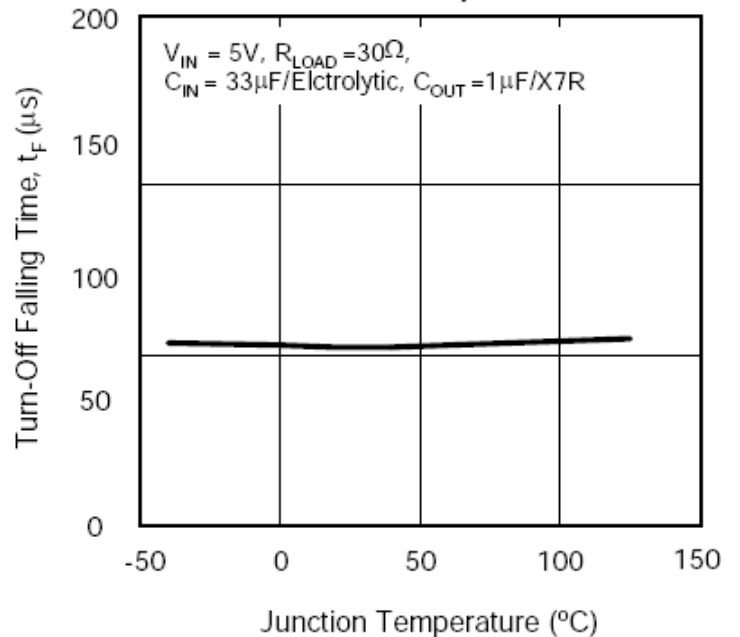

Typical Operating Characteristics(Cont.)

Turn-On Rising Time vs. Junction Temperature

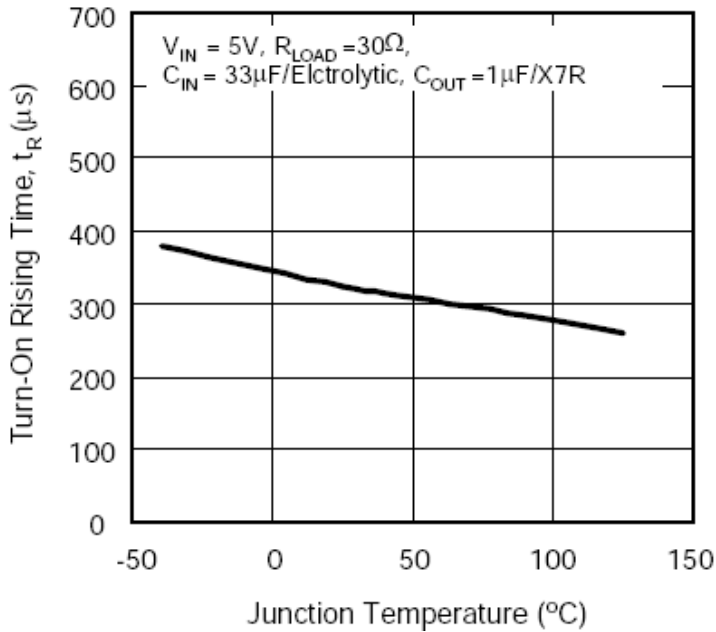

Switch Off Supply Current vs. Junction Temperature

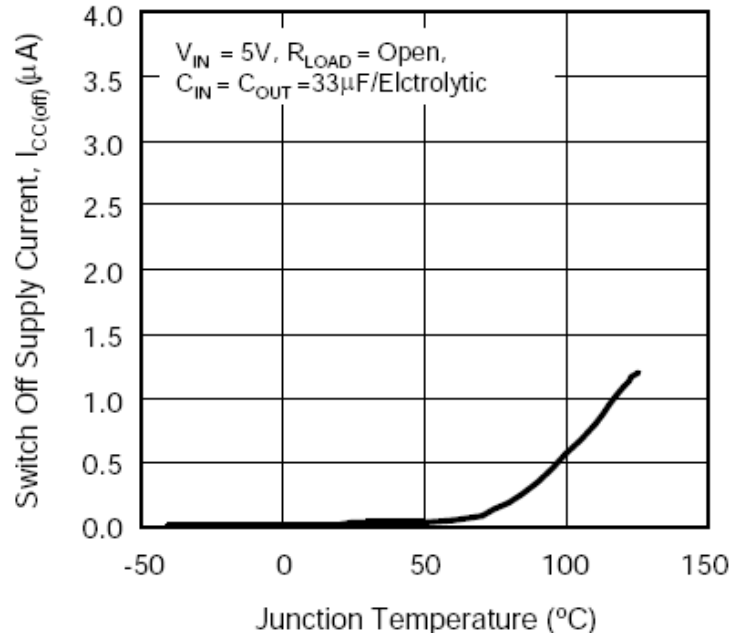

Output Voltage vs. Output Current

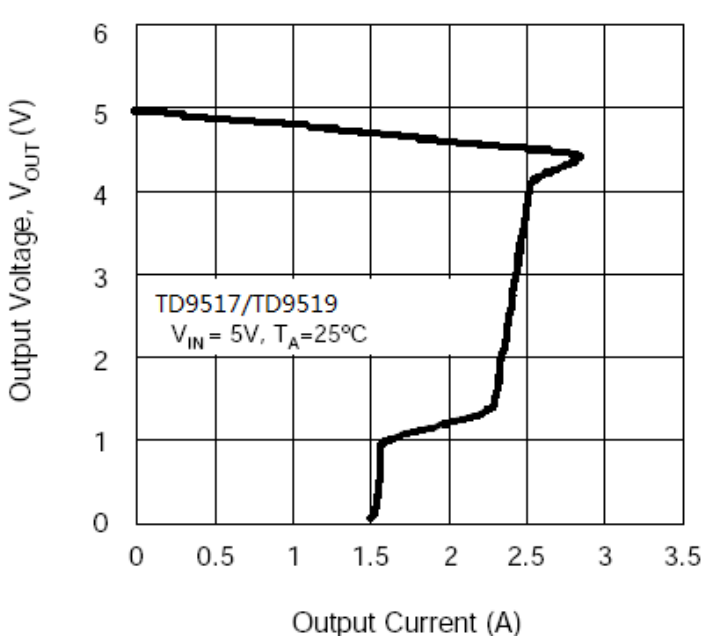

Output Voltage vs. Output Current

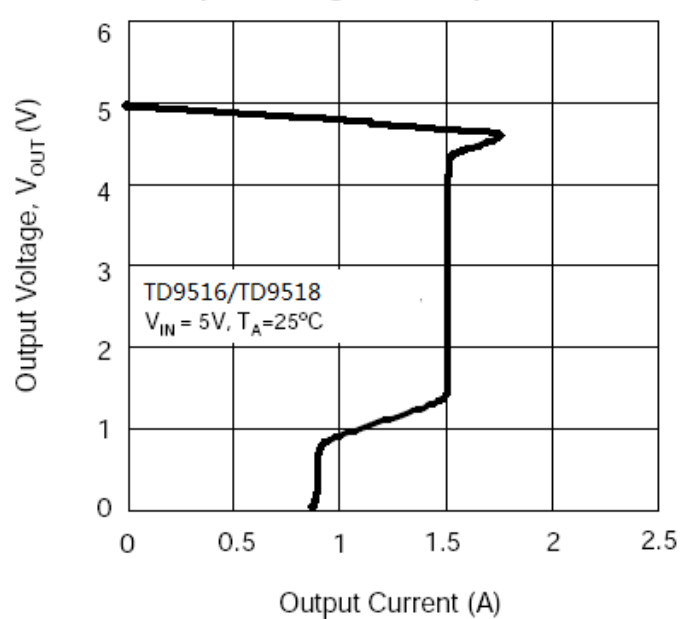

Operating Waveforms

Turn On Response

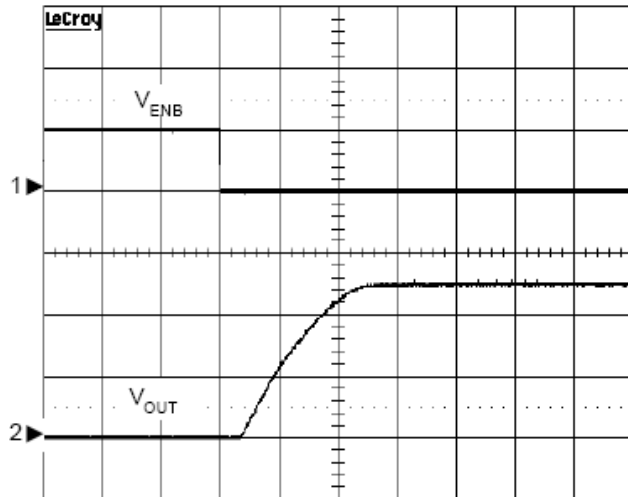

$V_{IN} = 5V$, $R_{LOAD} = 30\Omega$, $C_{IN} = 33\mu F$ /Electrolytic,

$C_{OUT} = 1\mu F$ /Electrolytic

CH1: V_{ENB} , 5V/Div, DC

CH2: V_{OUT} , 2V/Div, DC

TIME: 200µs/Div

UVLO at Rising

Turn Off Response

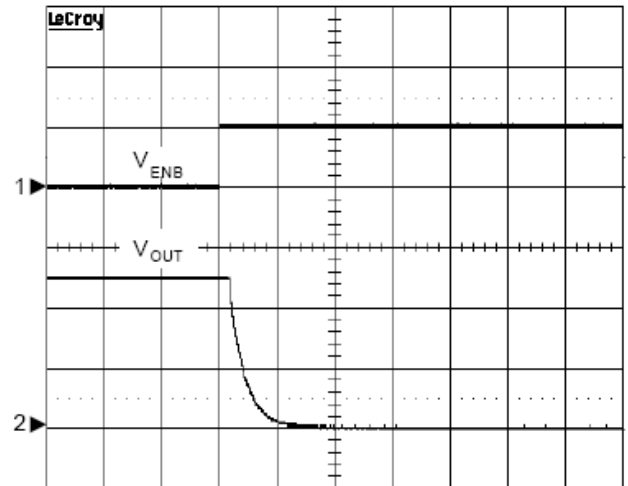

$V_{IN} = 5V$, $R_{LOAD} = 30\Omega$, $C_{IN} = 33\mu F$ /Electrolytic,

$C_{OUT} = 1\mu F$ /Electrolytic

CH1: V_{ENB} , 5V/Div, DC

CH2: V_{OUT} , 2V/Div, DC

TIME: 100µs/Div

UVLO at Falling

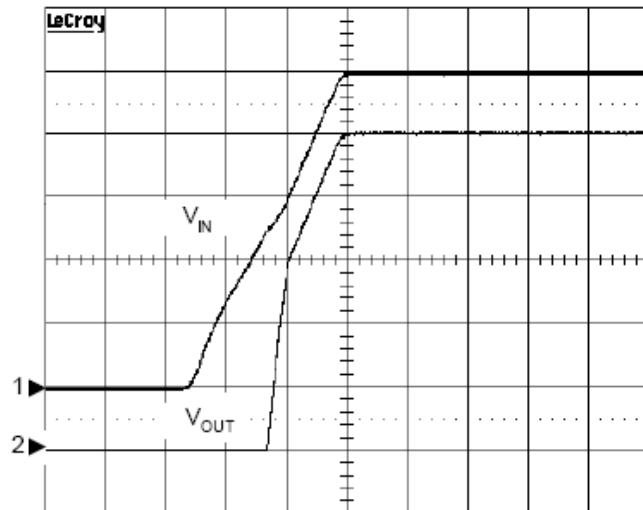

$V_{IN} = 5V$, $R_{LOAD} = 30\Omega$, $C_{IN} = 33\mu F$ /Electrolytic,

$C_{OUT} = 1\mu F$ /Electrolytic

CH1: V_{IN} , 1V/Div, DC

CH2: V_{OUT} , 1V/Div, DC

TIME: 2ms/Div

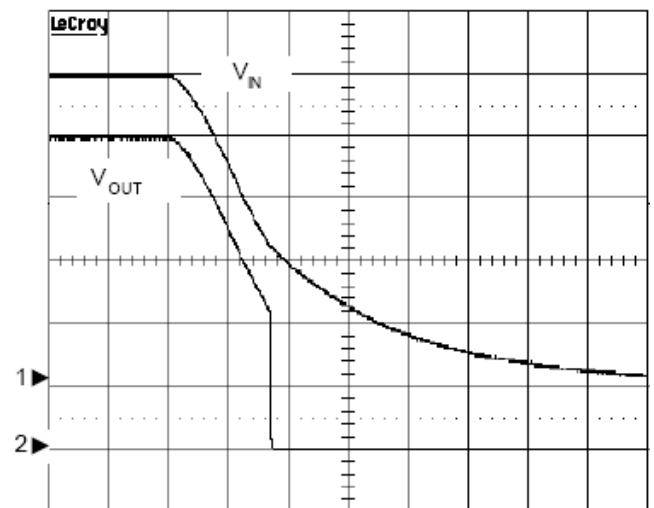

$V_{IN} = 5V$, $R_{LOAD} = 30\Omega$, $C_{IN} = 33\mu F$ /Electrolytic,

$C_{OUT} = 1\mu F$ /Electrolytic

CH1: V_{IN} , 1V/Div, DC

CH2: V_{OUT} , 1V/Div, DC

TIME: 2ms/Div

Operating Waveforms(Cont.)

OCB Response during Short Circuit

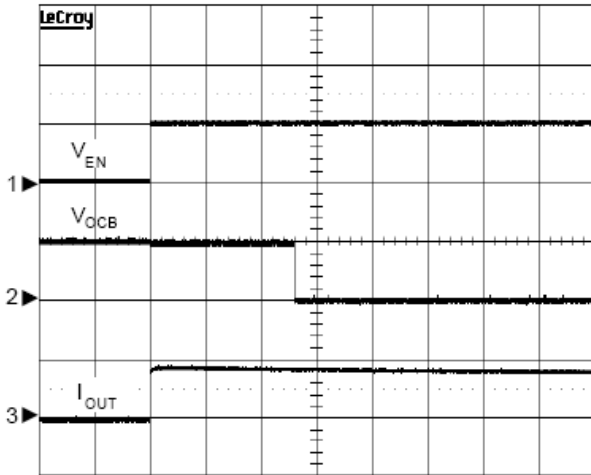

TD9516A, $V_{IN}=5V$, OUT short to GND,

$C_{IN}=C_{OUT}=33\mu F$ /Electrolytic

CH1: V_{EN} , 5V/Div, DC

CH2: V_{OCB} , 5V/Div, DC

CH3: I_{OUT} , 1A/Div, DC

TIME: 5ms/Div

OCB Response with Ramped Load

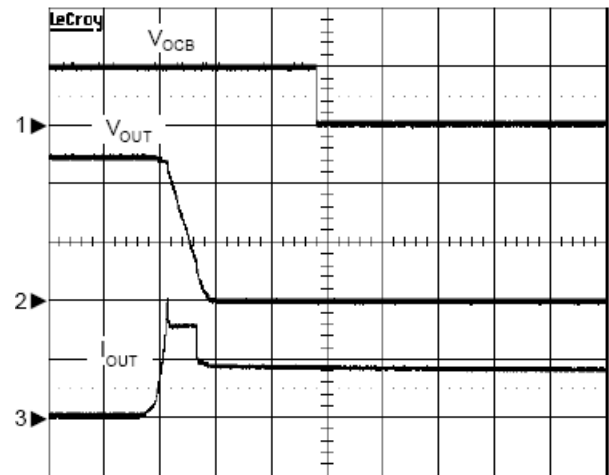

TD9516A, $V_{IN}=5V$, $C_{IN}=C_{OUT}=33\mu F$ /Electrolytic

CH1: V_{OCB} , 5V/Div, DC

CH2: V_{OUT} , 2V/Div, DC

CH3: I_{OUT} , 1A/Div, DC

TIME: 5ms/Div

Short Circuit Response

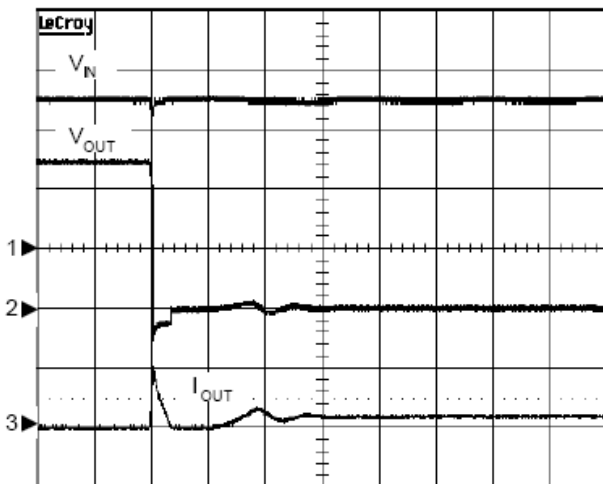

TD9516A, $V_{IN}=5V$, OUT Short to GND,

$C_{IN}=33\mu F$ /Electrolytic, No C_{OUT}

CH1: V_{IN} , 2V/Div, DC

CH2: V_{OUT} , 2V/Div, DC

CH3: I_{OUT} , 5A/Div, DC

TIME: 50 μs /Div

Load Transient Response

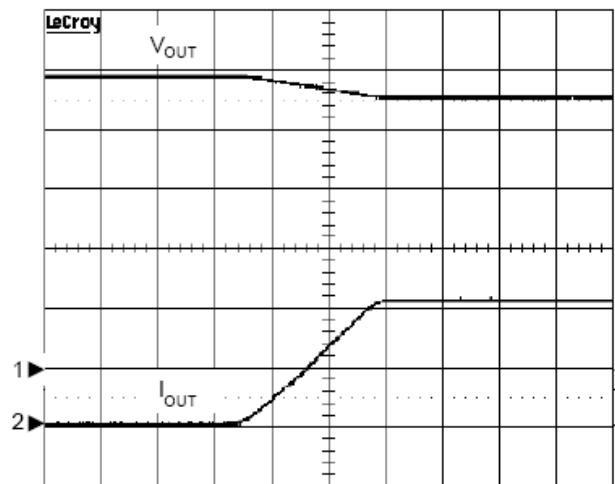

TD9517A, $V_{IN}=5V$, $R_{LOAD}=1k\Omega$ to 2.2Ω ,

$C_{IN}=C_{OUT}=33\mu F$ /Electrolytic

CH1: V_{OUT} , 1V/Div, DC

CH2: I_{OUT} , 1A/Div, DC

TIME: 1ms/Div

Type Application Circuit

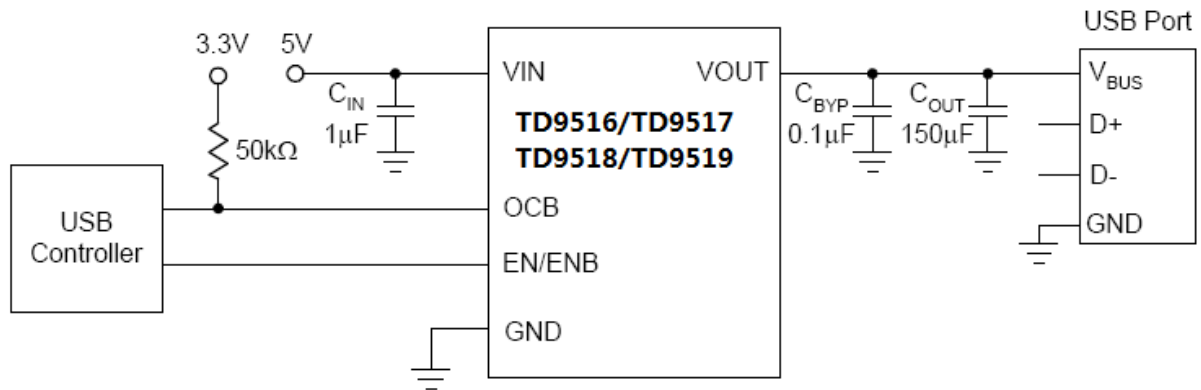

Function Description

VIN Under-Voltage Lockout (UVLO)

The TD951X series of power switches have a built-in under-voltage lockout circuit to keep the output shutting off until internal circuitry is operating properly. The UVLO circuit has hysteresis and a de-glitch feature so that it will typically ignore undershoot transients on the input. When input voltage exceeds the UVLO threshold, the output voltage starts a soft-start to reduce the inrush current.

Power Switch

The power switch is an N-channel MOSFET with a low $R_{DS(ON)}$. The internal power MOSFET does not have the body diode. When IC is off, the MOSFET prevents a current flowing from the VOUT back to VIN and VIN to VOUT.

Current-Limit Protection

The TD951X series of power switches provide the current-limit protection function. During current-limit, the devices limit output current at current limit threshold. For reliable operation, the device should not be operated in current-limit for extended period.

Short-Circuit Protection

When the output voltage drops below 1.5V, which is caused by an over-load or a short-circuit, the devices limit the output current down to a safe level. The short-circuit current limit is used to reduce the power dissipation during short-circuit conditions. If the junction temperature reaches over-temperature threshold, the device will enter the thermal shutdown.

OCB Output

The TD951X series of power switches provide an open-drain output to indicate that a fault has occurred. When any of current-limit or over-temperature protection occurs for a deglitch time of $t_{D(OCB)}$, the OCB goes low. Since the OCB pin is an open-drain output, connecting a resistor to a pull high voltage is necessary.

Enable/Disable

Pull the ENB above 2V or EN below 0.8V will disable the device, and pull ENB pin below 0.8V or EN above 2V will enable the device. When the IC is disabled, the supply current is reduced to less than $1\mu A$. The enable input is compatible with both TTL and CMOS logic levels. The EN/ENB pin cannot be left floating.

Over-Temperature Protection

When the junction temperature exceeds $140^{\circ}C$, the internal thermal sense circuit turns off the power FET and allows the device to cool down. When the device's junction temperature cools by $20^{\circ}C$, the internal thermal sense circuit will enable the device, resulting in a pulsed output during continuous thermal protection. Thermal protection is designed to protect the IC in the event of over temperature conditions. For normal operation, the junction temperature cannot exceed $T_{J=+125^{\circ}C}$.

Application Information

Input Capacitor

A 1 μ F ceramic bypass capacitor from V_{IN} to GND, located near the TD951X, is strongly recommended to suppress the ringing during short circuit fault event. Without the bypass capacitor, the output short may cause sufficient ringing on the input (from supply lead inductance) to damage internal control circuitry.

Output Capacitor

A low-ESR 150 μ F aluminum electrolytic or tantalum between V_{OUT} and GND is strongly recommended to reduce the voltage drop during hot-attachment of downstream peripheral. (Per USB 2.0, output ports must have a minimum 120 μ F of low-ESR bulk capacitance per hub).

Higher-value output capacitor is better when the output load is heavy. Additionally, bypassing the output with a 0.1 μ F ceramic capacitor improves the immunity of the device to short-circuit transients.

Layout Consideration

The PCB layout should be carefully performed to maximize thermal dissipation and to minimize voltage drop, droop and EMI. The following guidelines must be considered:

1. Please place the input capacitors near the V_{IN} pin as close as possible.
2. Output decoupling capacitors for load must be placed near the load as close as possible for decoupling highfrequency ripples.
3. Locate TD951X and output capacitors near the load to reduce parasitic resistance and inductance for excellent load transient performance.
4. The negative pins of the input and output capacitors and the GND pin must be connected to the ground plane of the load.
5. Keep V_{IN} and V_{OUT} traces as wide and short as possible.

Package Information

TSOT23-5 Package Outline Dimensions

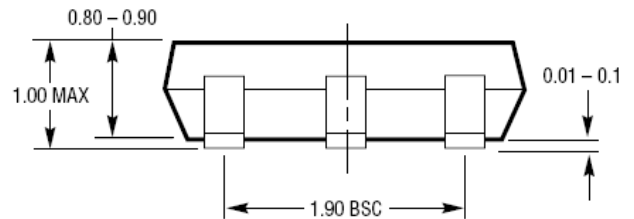
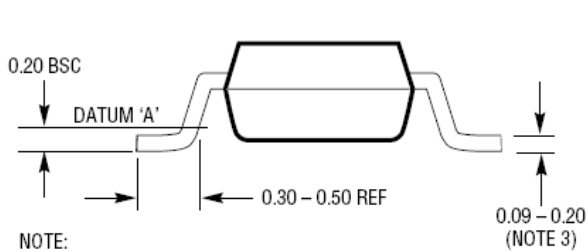
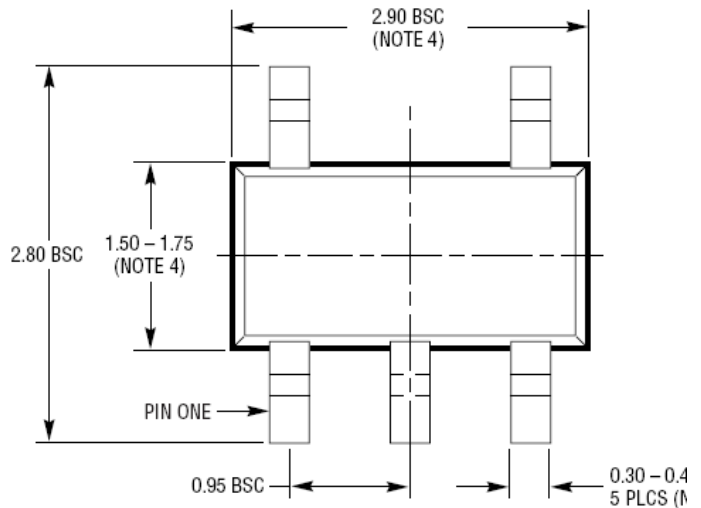
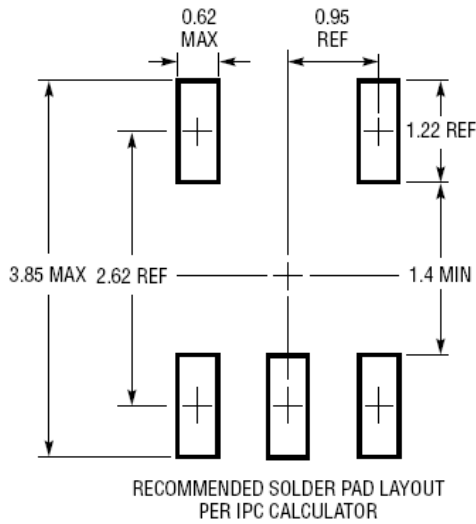

- NOTE:
1. DIMENSIONS ARE IN MILLIMETERS
 2. DRAWING NOT TO SCALE
 3. DIMENSIONS ARE INCLUSIVE OF PLATING
 4. DIMENSIONS ARE EXCLUSIVE OF MOLD FLASH AND METAL BURR
 5. MOLD FLASH SHALL NOT EXCEED 0.254mm
 6. JEDEC PACKAGE REFERENCE IS MO-193

55 TSOT-23 0302

Design Notes