

High Brightness Boost LED Driver with 1:3000 Dimming Ratio and Excellent Current Regulation

General Description

The AN9911DB1 is an LED driver capable of driving up to 20 one-watt LEDs in series from an input of 21 – 27V DC. The demoboard uses AN9911 in a boost topology.

The converter has a very good initial regulation ($\pm 5\%$) and excellent line and load regulation over the entire input and output voltage range ($< \pm 1\%$). The full load efficiency of the converter is typically greater than 90%.

The AN9911DB1 is also protected against open LED and output short circuit conditions. It is also protected under input undervoltage conditions by limiting the input current. It has an excellent PWM dimming response, with typical rise and fall times less than $2\mu\text{s}$, which will allow high PWM dimming ratios.

The switching frequency of the AN9911DB1 can be synchronized to other AN9911 boards or to an external 200kHz clock by connecting the clock to the SYNC pin of the AN9911DB1.

Specifications	
Input Voltage (steady state):	21V – 27V DC
Output LED string voltage:	35V min - 80V max
Output current:	350mA $\pm 5\%$
Output Current Ripple:	10% typical
Switching Frequency:	200kHz
Full Load Efficiency:	93% (at 24V input)
Open LED protection:	Shuts down at 92V
Output short circuit protection:	Included
Input under voltage protection:	Included
PWM Dimming:	1:3000 dimming ratio at 200Hz

Board Layout and Connection Diagram

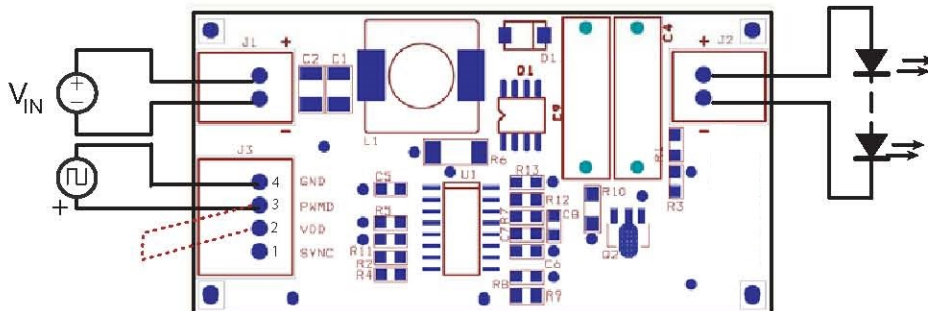

Connections:

Input: The input is connected between the terminals of connector J1 as shown in the Connection Diagram.

Output: The output is connected between the terminals of connector J2 as shown.

Enable/PWM Dimming: To just enable the board, short pins PWM and V_{DD} of connector J3 as shown by the dashed lines. To PWM dim the board, connect the external push-pull waveform source between terminals PWM and GND of connector J3 as shown by the solid lines.

Note: During PWM dimming, pin 2 of connector J3 should be left open. Also, the PWM signal must have the proper polarity with the positive connected to pin 3 of J3. Note that pin 4 of J3 is internally connected to the return path of the input voltage.

SYNC: To synchronize two or more boards, connect the SYNC pins of all the boards together. To synchronize the AN9911DB1 to an external 200kHz clock, connect the clock between the SYNC and GND pins of terminal J3.

Testing The Demoboard:

Normal Operation: Connect the input source and the output LEDs as shown in the Connection Diagram and enable the board. The LEDs will glow with a steady intensity. Connecting an ammeter in series with the LEDs will allow measurement of the LED current. The current will be 350mA +/- 5%.

Current Regulation: With the input power to the converter disconnected, change the LED string voltage within the specifications mentioned. The current output of the AN9911DB1 will remain very steady over the entire load range. Vary the input voltage while the circuit is operational. The current will be regulated over the entire line range.

Open LED test: Connect a voltmeter across the output terminals of the AN9911DB1. Start the demoboard normally and once the LED current reaches steady state, unplug one end of the LED string from the demoboard. The output voltage will rise to about 92V and then the AN9911DB1 will shut down. To restart the converter, disconnect and reconnect the input voltage (recycle the power to the board).

Short Circuit Test: When the AN9911DB1 is operating in steady state, connect a jumper across the terminals of the LED string. Notice that the output current will immediately go to zero and the converter will shut down. To restart the AN9911DB1, recycle the input power to the demoboard.

PWM Dimming: With the input voltage to the board disconnected, apply a TTL compatible, push-pull square wave signal between PWMD and GND terminals of connector J3 as shown in the Connection Diagram. Turn the input voltage back on and adjust the duty cycle and / or frequency of the PWM dimming signal. The output current will track the PWM dimming signal. Note that although the converter operates perfectly well at 1kHz PWM dimming frequency, the widest PWM dimming ratio can be obtained at lower frequencies like 100 or 200Hz.

Typical Results:

1. Efficiency: The efficiency of the converter at various LED string voltages are shown in Fig.1 (measured at the nominal input voltage of 24V). Fig.2 shows the full load efficiency of the converter at varying input voltages. The minimum efficiency of 93% for the converter occurs at 21V input and full load output.

2. Current Regulation: Figs. 3 and 4 show the output current regulation vs. output voltage and input voltage respectively. The total current regulation (line and load combined) is found to be less than 1%.

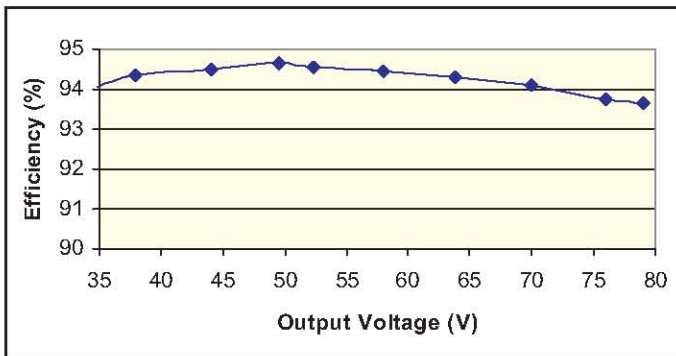

Fig. 1. Efficiency vs. Output Voltage

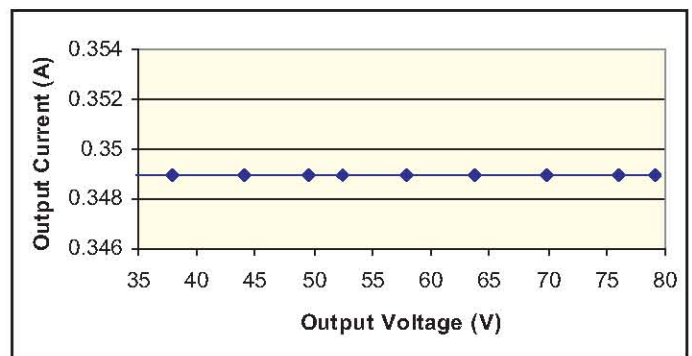

Fig. 3. Output Current vs. Output Voltage

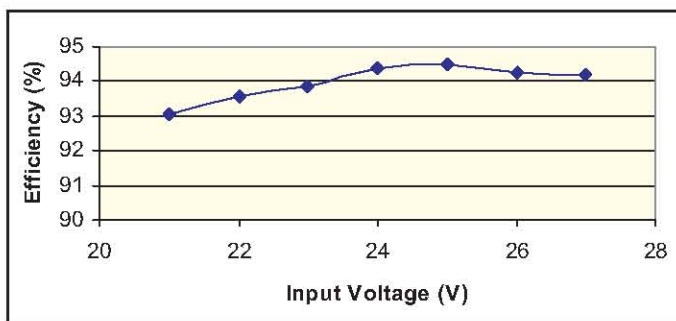

Fig. 2. Efficiency vs. Input Voltage

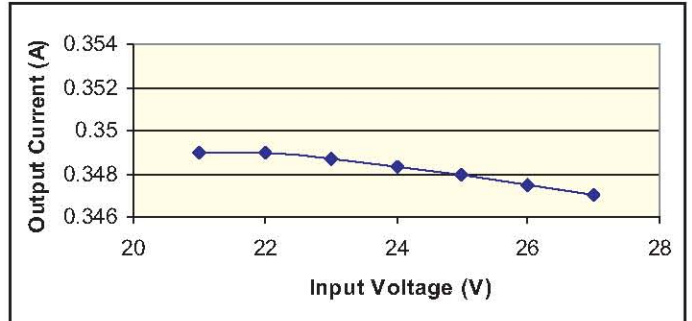

Fig. 4. Output Current vs. Input Voltage

3. Input Under Voltage Protection: Input under voltage protection is provided by limiting the input current at low input voltages. Fig. 5 shows the output and input currents at voltages less than the minimum rated voltage. The LED current will decrease as the input voltage falls and the input current limits to about 1.4A. Note that the input current limit is not a hard limit as the slope compensation added to the peak current sense signal will allow a small change in the input current with a decrease in the input voltage.

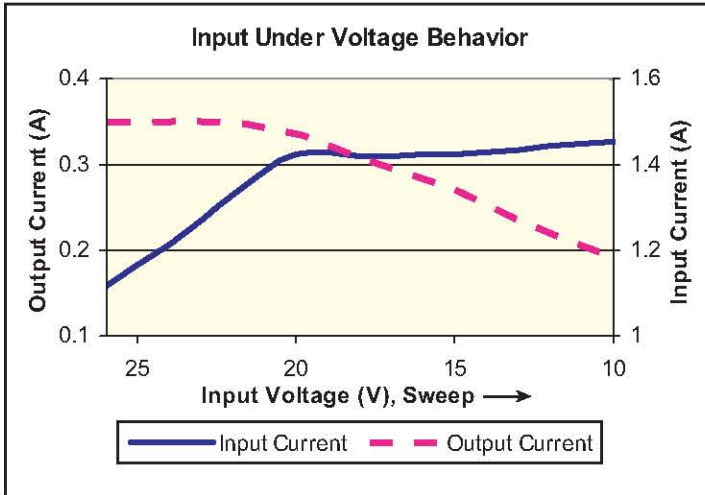

Fig. 5. Input Under Voltage Behavior

4. Open LED Protection: Open LED protection for the circuit is set at 92V. The waveforms in Fig. 6 show the output voltage, drain voltage and output current during an open LED condition. The time taken for the over voltage protection to shut the IC down will depend on the size of the output capacitor.

5. Output Short Circuit Protection: Fig. 7 shows the waveforms for output short circuit condition. The disconnect FET is turned off in less than 300ns. The rise in the output current will depend on the input voltage and the value of inductor L1. The same protection will also help in protecting the LEDs in case the output voltage increases beyond the LED string voltage.



Fig. 6: Open LED Protection (20µs/div)

6. PWM Dimming: The rise and fall transitions of the LED current during PWM dimming are shown in Figs. 8 and 9, at output voltages of 80V and 40V respectively. The timescale for all waveforms is set at 5.0µs/div. The rise and fall times are less than 1.0µs in each case. Thus, a PWM dimming ratio of 1:3000 is achievable at a PWM dimming frequency of 200Hz.

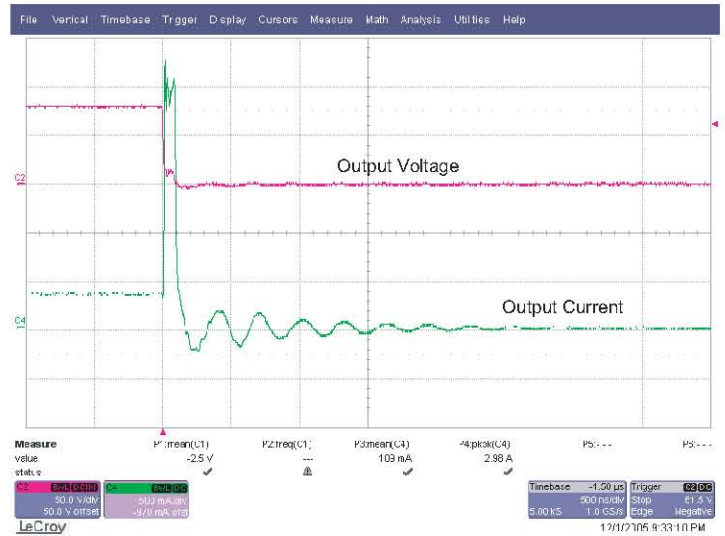

Fig. 7: Output Short Circuit Protection (500ns/div)

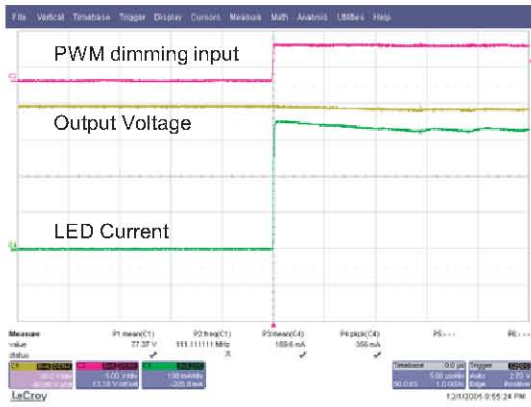

Fig. 8a: Rise time of LED Current at 80V output (5 μ s/div)

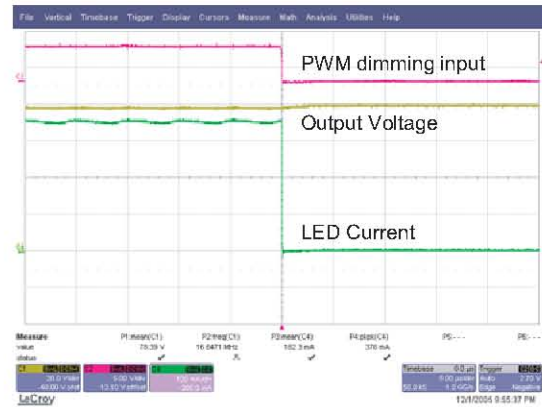

Fig. 8b: Fall time of LED Current at 80V output (5 μ s/div)



Fig. 9a: Rise time of LED Current at 40V output (5 μ s/div)

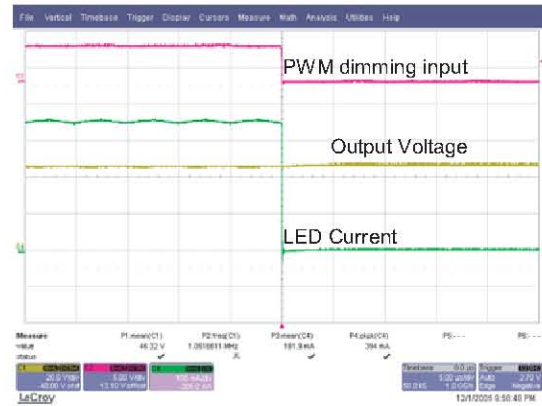
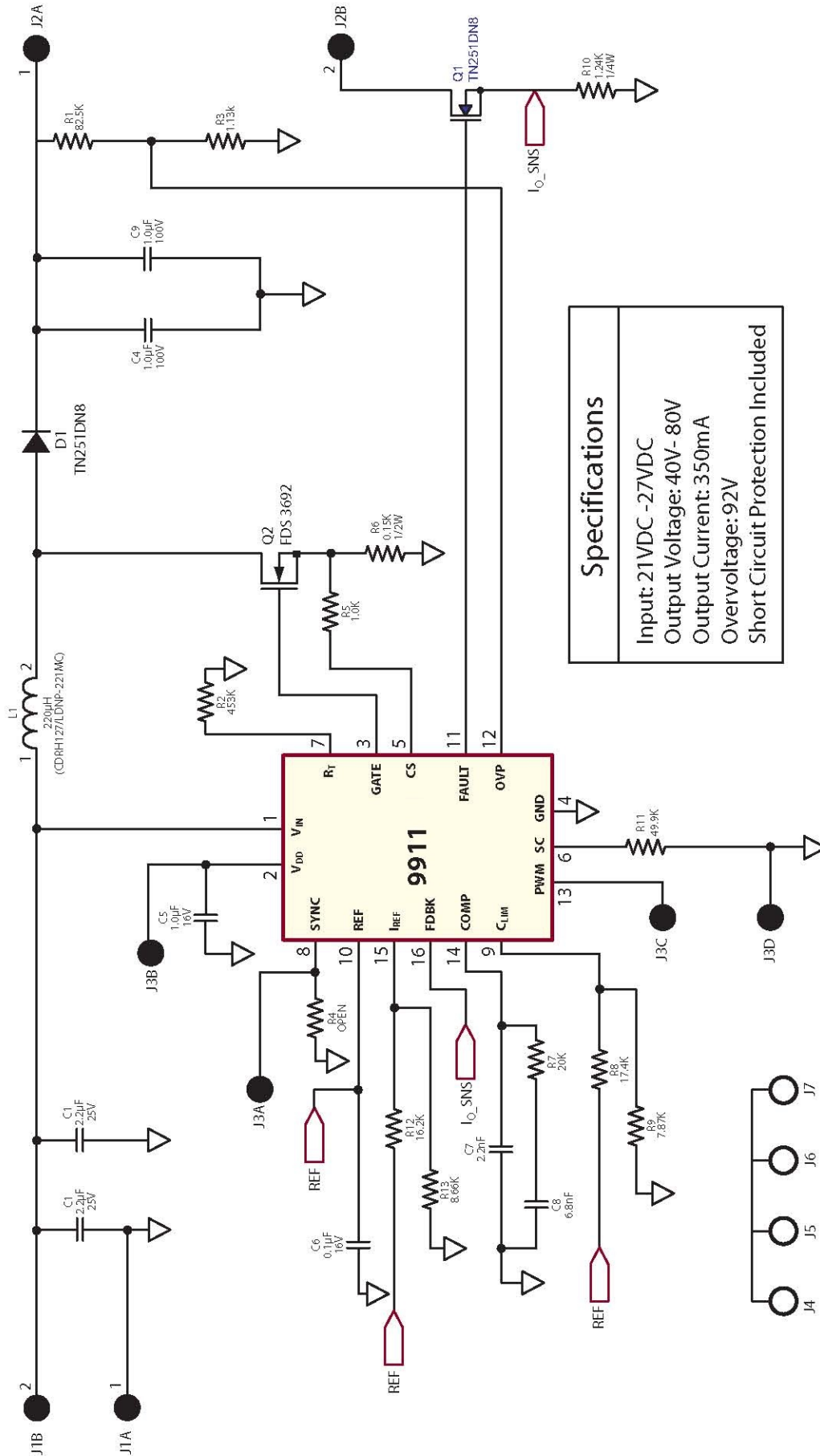
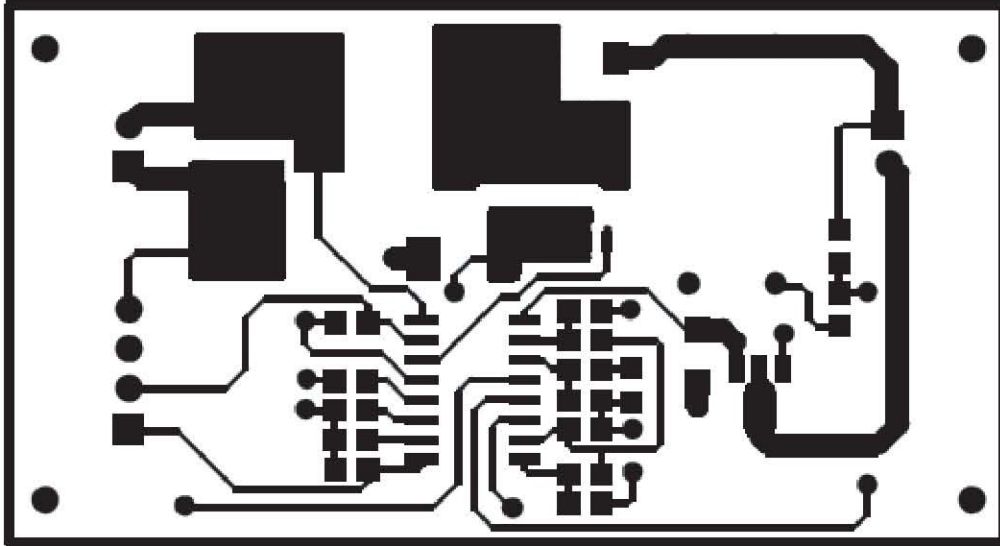

Fig. 9b: Fall time of LED Current at 40V output (5 μ s/div)

Circuit Schematic:



Top Layer:



Bottom Layer:

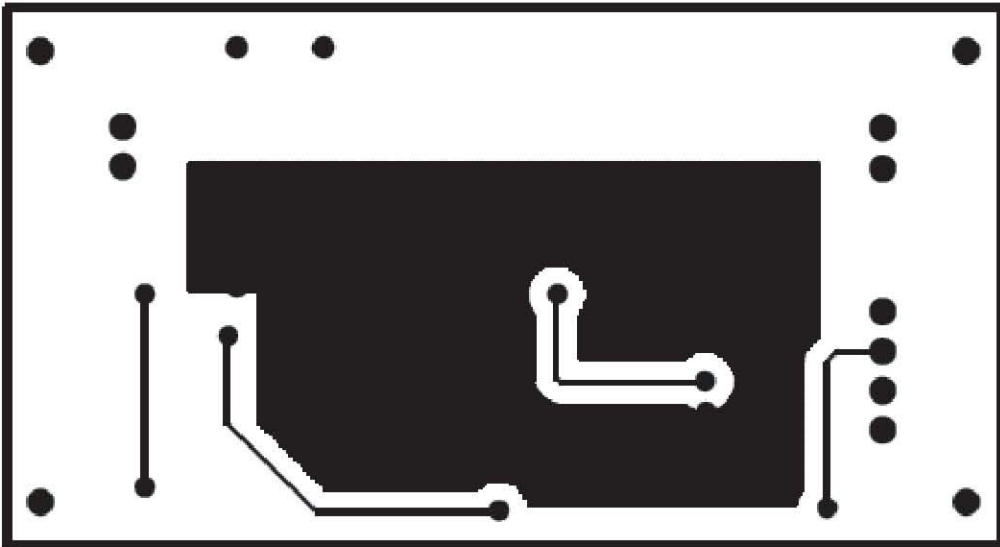

Silk Screen:

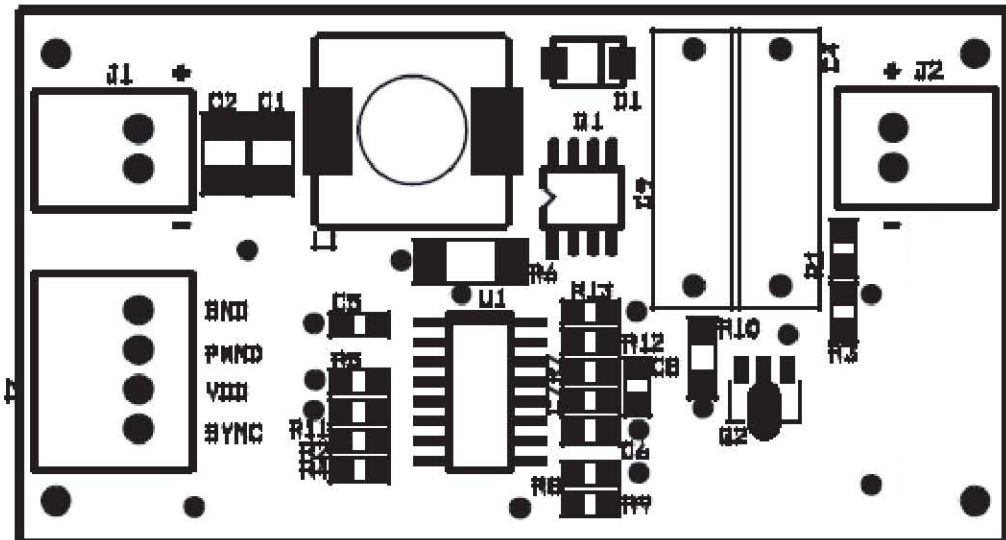

Bill of Materials

Item #	Quantity	RefDes	Description	Package	Manufacturer	Manufacturer's Part Number
1	2	C1,C2	2.2uF, 25V, X7R ceramic chip capacitor	SMD1210	TDK Corp	C3225X7R1H225K
2	2	C4,C9	1uF, 100V metal polyester capacitor	Radial	EPCOS Inc	B32522C1105J
3	1	C5	1uF, 16V X7R ceramic chip capacitor	SMD0805	TDK Corp	C2012X7R1C105K
4	1	C6	0.1uF, 16V X7R ceramic chip capacitor	SMD0805	Murata	GRM219R71C104KA01D
5	1	C7	2.2nF, 5%, 50V C0G ceramic chip capacitor	SMD0805	TDK Corp	C2012C0G1H222J
6	1	C8	6.8nF, 5%, 50V C0G ceramic chip capacitor	SMD0805	TDK Corp	C2012C0G1H682J
7	1	D1	100V, 1A schottky diode	SMA	Diodes Inc.	B1100-13
8	2	J1,J2	Side Entry 2-pin male header	Thru-Hole	JST Sales Amer.	S2B-EH
9	1	J3	Side Entry 4-pin male header	Thru-Hole	JST Sales Amer.	S4B-EH
10	1	L1	220uH, 2A sat, 1.5A rms inductor	SMT	Sumida	CDRH127/LDNP-221MC
11	1	Q1	100V, 4.55A N-Channel MOSFET	SO-8	Fairchild	FDS3692
12	1	Q2	100V, 1.5ohm N-Channel MOSFET	SOT-89		TN2510N8
13	1	R1	82.5k, 1%, 1/8W chip resistor	SMD0805	Yageo	RC0805FR-0782K5L
14	1	R2	453k, 1%, 1/8W chip resistor	SMD0805	Yageo	RC0805FR-07453KL
15	1	R3	1.13k, 1%, 1/8W chip resistor	SMD0805	Yageo	RC0805FR-071K13L
16	1	R4	open			
17	1	R5	1k, 1%, 1/8W chip resistor	SMD0805	Yageo	RC0805FR-071KL
18	1	R6	0.15, 1%, 1/2W chip resistor	SMD2010	Vishay/ Dale	WSL2010R1500FEA
19	1	R7	20k, 1%, 1/8W chip resistor	SMD0805	Yageo	RC0805FR-0720KL
20	1	R8	17.4k, 1%, 1/8W chip resistor	SMD0805	Yageo	RC0805FR-0717K4L
21	1	R9	7.87k, 1%, 1/8W chip resistor	SMD0805	Yageo	RC0805FR-077K87L
22	1	R10	1.24, 1%, 1/4W chip resistor	SMD1206	Yageo	RC1206FR-071R24L
23	1	R11	49.9k, 1%, 1/8W chip resistor	SMD0805	Yageo	RC0805FR-0749K9L
24	1	R12	16.2k, 1%, 1/8W chip resistor	SMD0805	Yageo	RC0805FR-0716K2L
25	1	R13	8.66k, 1%, 1/8W chip resistor	SMD0805	Yageo	RC0805FR-078K66L
26	1	U1	Switchmode LED Driver with High Current Accuracy	SO-16		AN9911NG