



# Isolated LED Driver Demo Board

Input 180..260VAC, Output 0.35A, 90..120V (42W max.)

## General Description

The AN9961DB9 demo board is the offline isolated LED driver, using AN9961 IC. The AN9961 provides control of a flyback conversion and power factor correction in a single stage. This is the cost competitive solution due to low-cost IC approach and low part count on primary and secondary side. The isolated concept ensures easy and safe installation and maintenance for street lights and Indoor lighting fixtures. Using average current feedback via optocoupler, provides a good line and load regulation. Design is for a fixed output current features protection from an output short circuit condition and load overvoltage.

Specifications	
Input voltage	180VAC to 260VAC, 50Hz
Output voltage:	90 to 120V
Output current:	0.35A +/-5%
Output power:	42W
Power factor	0.9
Efficiency	84%
Output 100Hz current ripple	1.3%
Output short circuit protection	Yes
Switching frequency	About 200kHz ( depends on the input and output voltage)
Dimensions:	150 x 30 x 25 mm

This demo board intended for evaluation and testing purposes only, not for high volume and/or end product usage.

## Warning!

*Working with this board can cause serious bodily harm or death. Connecting the board to a source of line voltage will result in the presence of hazardous voltage throughout the primary side of system.*

*The board should only be handled by persons well aware of the dangers involved with working on live electrical equipment. Extreme care should be taken to protect against electric shock. Disconnect the board before attempting to make any changes to the system configuration. Always work with another person nearby who can offer assistance in case of an emergency. Wear safety glasses for eye protection.*

*The electrolytic capacitor carries a hazardous voltage for an extended time after the board is disconnected. Check the capacitor voltage before handling the board.*

## Board Layout and Connections

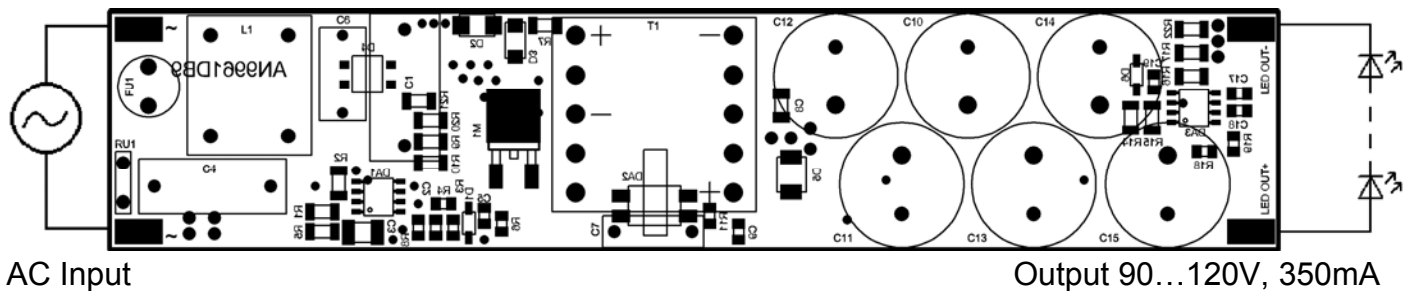



Schematic Diagram

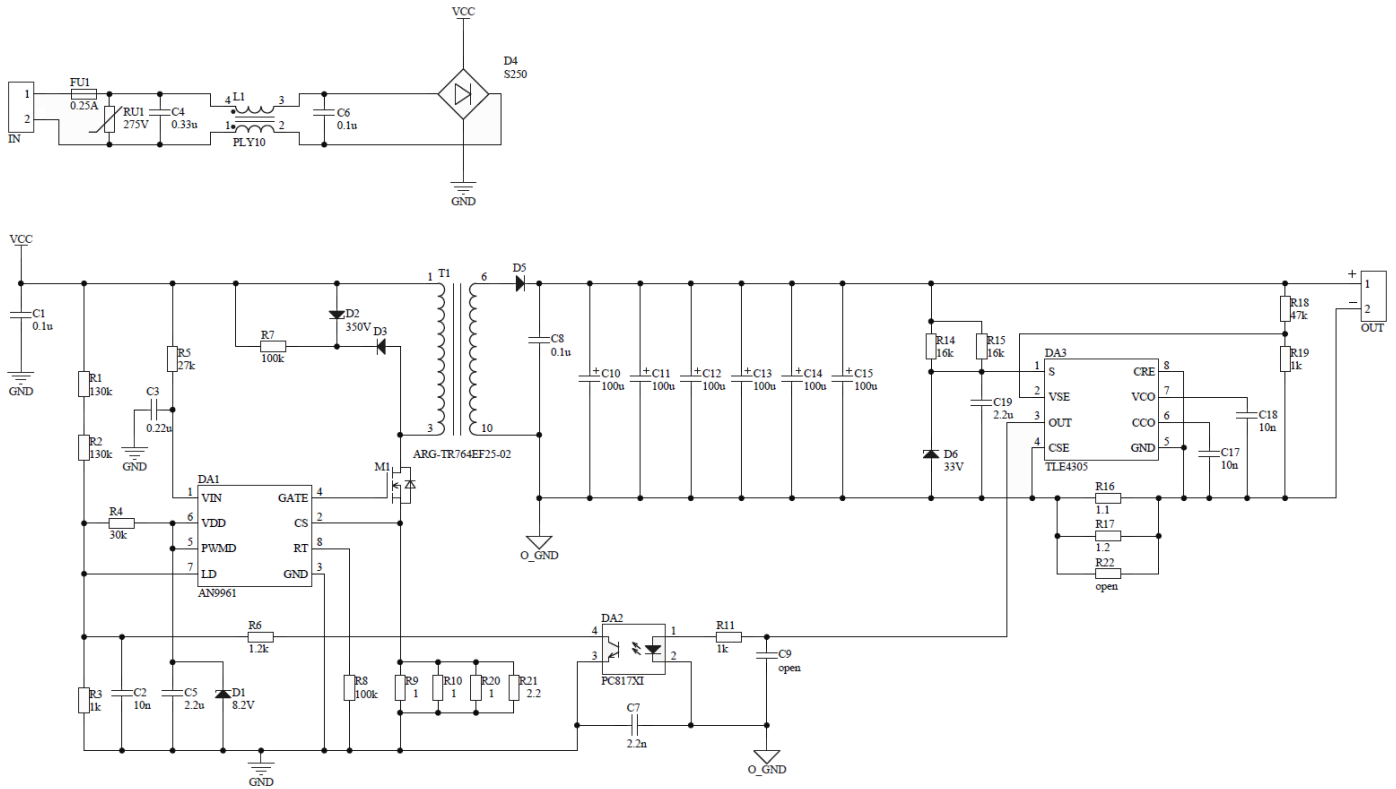



### Connection Instructions

1. Carefully inspect the board for shipping damage, loose components, etc, before making connections.
2. Attach the board to the line and load as shown in the diagram. Be sure to check for correct polarity when connecting the LED string to avoid damage to the string. The board is short circuit and open circuit proof. The LED string voltage can be anything between 90 and 120V.
3. Energize the mains supply.

### Principles of Operation

The topology of the AN9961DB9 is in principal a peak-current mode flyback converter, operating with fixed off-time of 4.3 $\mu$ s. The current on the primary side is sensed via the sense resistors (R9, R10, R20, R21). If this current reaches the threshold (CS threshold of AN9961), the main switch (MOSFET M1) is turned off. After the off-time (controlled by AN9961) expires, the main switch is turned on. The timing resistor R8 connected to RT determines the off-time of the driver IC.

Auxiliary components (R5, D1, C3 and C5) used to power supply the controller.

To achieve a high power factor, the peak current is modulated in a way to follow the rectified mains input voltage. The input voltage is sensed via a resistive divider (R1, R2, R3) and this signal is mixed with the feedback signal via optocoupler DA2. This modulation of the peak current modulates the input current to follow the input voltage and allows for a very good power factor.

The AN9961DB9 allows for constant-current output control. For this control the TLE4305G is used on the secondary side to measure the output current and feedback the control signal via the optocoupler. The current is measured via the sense resistors (R16, R17, R22) on the secondary side. To minimize the losses in the sense resistor, the TLE4305G allows for a very low sense voltage of 0.2 V. Additionally the TLE4305G measures the output voltage and switches to a constant-voltage regulation in case the output voltage exceeds the limit set by the resistive divider (R18, R19). The time constants for the cc and cv regulation loop can be set independently with the capacitors (C17, C18). It is necessary that the current regulation time constant is lower than the mains AC frequency. On the other side the voltage regulation must be fast, to avoid an overshoot at startup. The current regulation for a load is set for 0.35A.



### Typical Characteristics

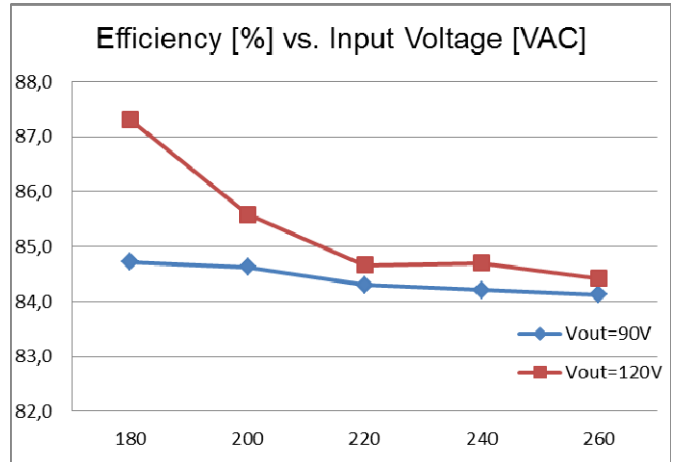
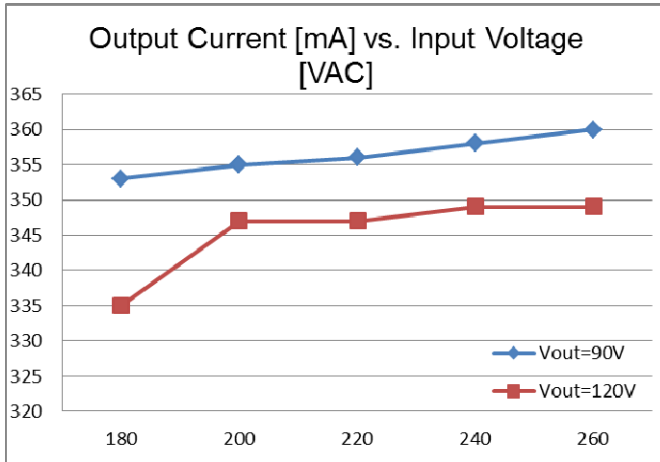

### Waveforms (220VAC input)

Drain voltage

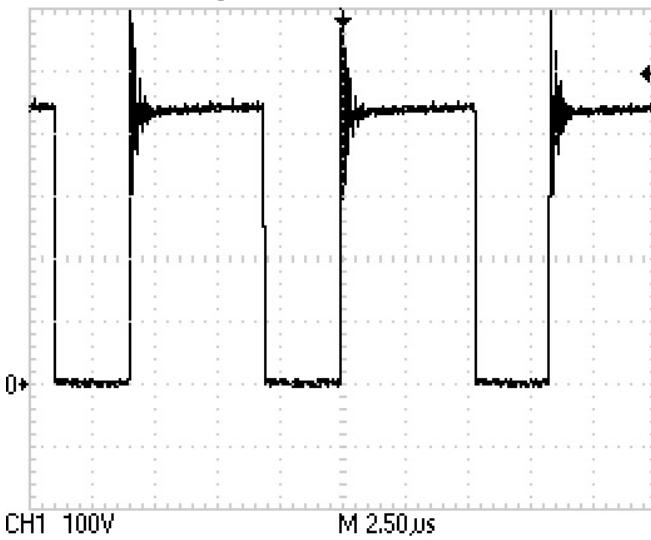

Drain voltage (overview)

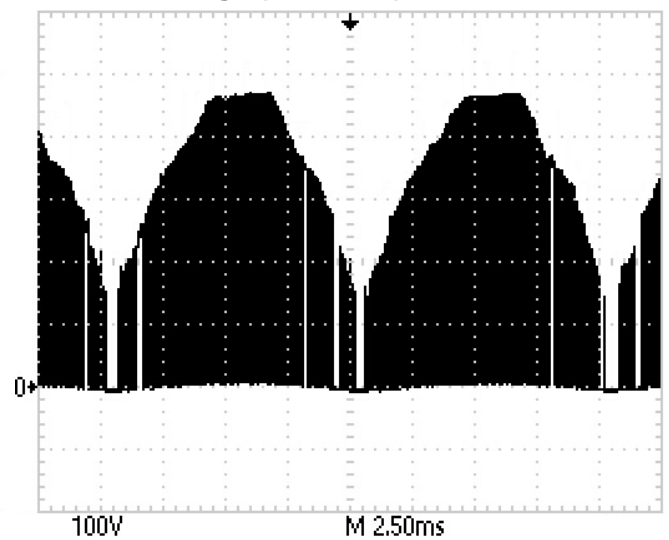

Input current

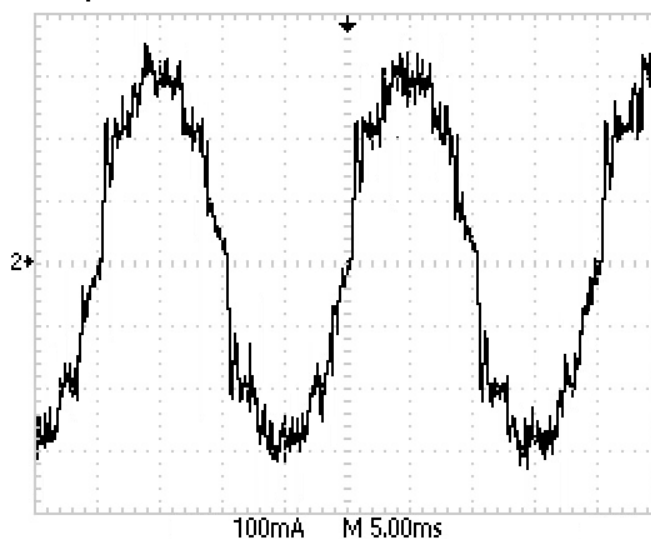

Output current

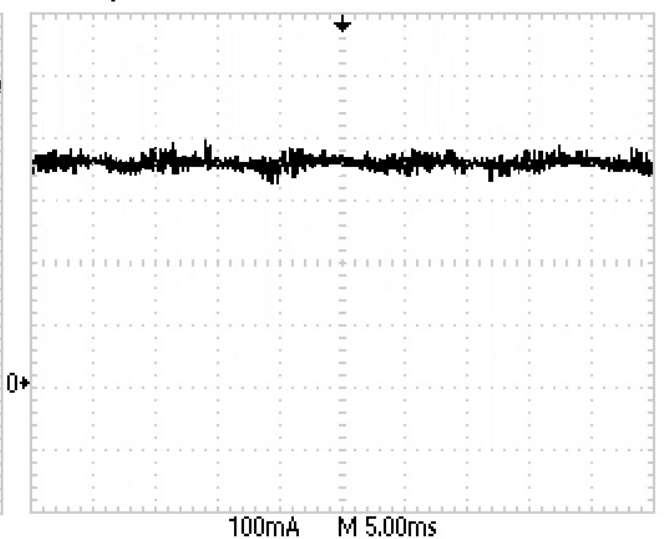



PCB Layout

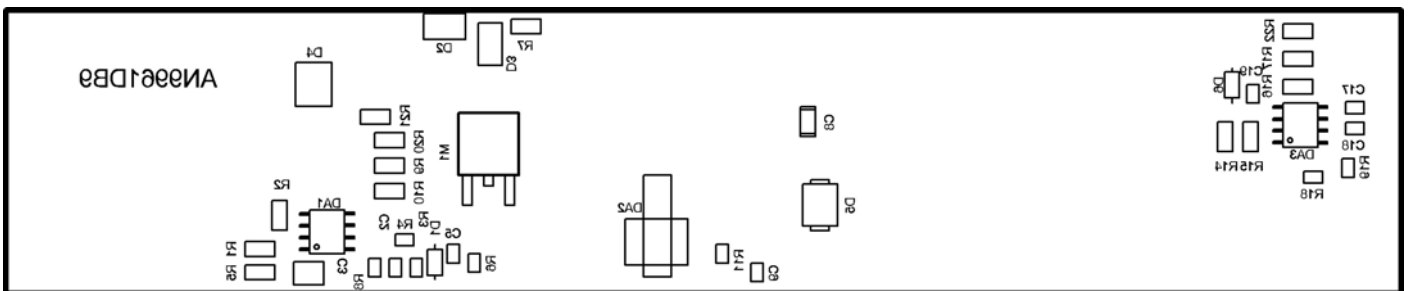
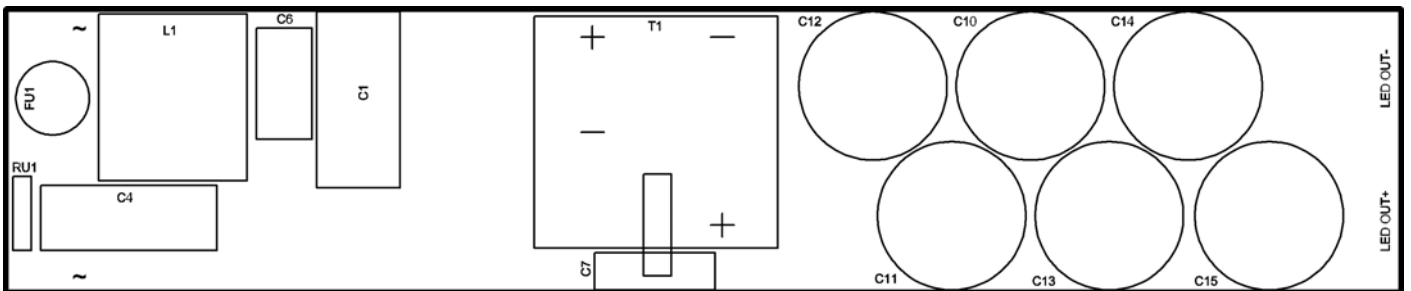
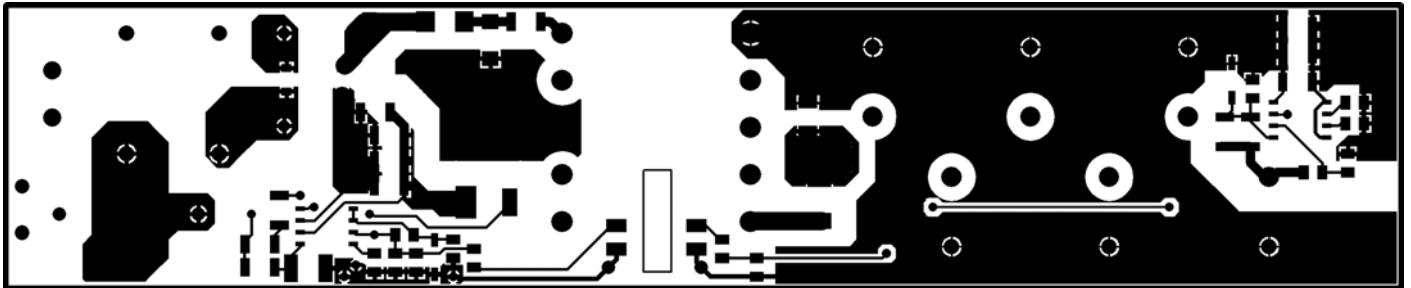
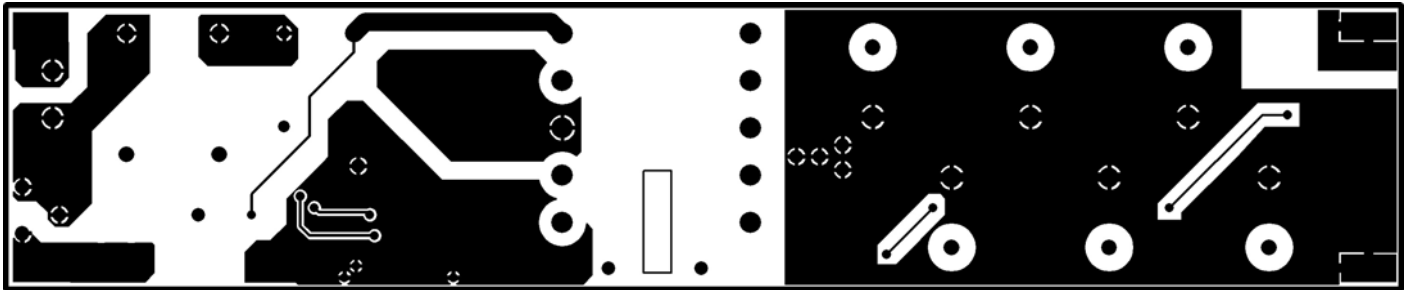



**Bill of Materials**

Qty	REF	Description	Manufacturer	Product Number
1	C1	Cap MEF 0.1uF 400V	Shengxin	CL21-0.1uF-400V
3	C2, C17, C18	Cap Cer X7R 0805 10nF 50V	-	-
1	C3	Cap Cer X7R 1210 0.22uF 630V	-	-
1	C4	Cap Film MKP X2 0.33uF 305VAC	Epcos	B32922C3334M
2	C5, C19	Cap Cer X7R 0805 2.2uF 50V	-	-
1	C6	Cap Film MKP X2 0.1uF 305VAC	Epcos	B32921C3104M
1	C7	Cap X1Y1 2.2nF 250V	Murata	DE1E3KX222M
1	C8	Cap Cer X7R 1206 0.01uF 600V	-	-
1	C9	Open	-	-
6	C10...C15	Cap AlEl Rad 100uF 160V	Epcos	B43858G1107M
1	DA1	IC LED Driver SO-8	Angstrom	AN9961
1	DA2	OptoCoupler	Sharp	PC817
1	DA3	Current & Voltage Control IC	Infineon	TLE4305
1	FU1	Fuse 250VAC 0.25A	Conquer	MET0.25
1	L1	EMI Filter 2.1 mH 1.4A	Murata	PLY10AN2121R4R2
1	M1	Transistor N-MOS 650V 1.4Ohm 12 nC	Infineon	SPD03N60C3
2	R1, R2	Res 1206 5% 130kOhm	-	-
3	R3, R11, R19	Res 0805 5% 1kOhm	-	-
1	R4	Res 0805 5% 30kOhm	-	-
1	R5	Res 1206 5% 27kOhm	-	-
1	R6	Res 0805 5% 1.2kOhm	-	-
1	R7	Res 1206 5% 100kOhm	-	-
1	R8	Res 0805 5% 100kOhm	-	-
3	R9, R10, R20	Res 1206 1% 10hm	-	-
2	R14, R15	Res 1206 5% 16kOhm	-	-
1	R16	Res 1206 1% 1.10hm	-	-
1	R17	Res 1206 1% 1.20hm	-	-
1	R18	Res 0805 5% 47kOhm	-	-
1	R21	Res 1206 1% 2.20hm	-	-
1	R22	Open	-	-
1	RU1	Sur Absorber 5mm 430V 600A ZNR	Panasonic	ERZV05D431
1	T1	Fly Back Transformer	Cipem	ARG-TR764EF25-02
1	D1	Diode Zener 8.2V 0.5W	Vishay	BZX55C8V2
1	D2	Diode TVS 350V 3.3W	Littlefuse	SMAJ350A
1	D3	Diode Ultra-Fast 600V 1A SMA	ST Microelectronics	STTH108A
1	D4	Rect Bridge MiniDIL 600V 0.5A	Diotec	S250
1	D5	Diode Ultra-Fast 800V 2A SMB	ST Microelectronics	STTH208A
1	D6	Diode Zener 33V 0.5W	Vishay	BZX55C33