



Isolated LED Driver Demo Board

Input 192..265VAC, Output 2.1A, 28..38V (80W max.)

General Description

The AN9961DB2_v2 demo board is the offline isolated LED driver, using AN9961 IC. The AN9961 provides control of a flyback conversion and power factor correction in a single stage. This is the cost competitive solution due to low-cost IC approach and low part count on primary and secondary side. The isolated concept ensures easy and safe installation and maintenance for street lights and Indoor lighting fixtures. Using average current feedback via optocoupler, provides a good line and load regulation (typically <1% over line and load). Design is for a fixed output current and a string of about 10 LEDs in series, features protection from an output short circuit condition, load overvoltage and open circuit

Specifications	
Input voltage	192VAC to 265VAC, 50Hz
Output voltage:	28 to 38V
Output current:	2.1A +/-1%
Output power:	80W
Power factor	98%
Efficiency	84%
Output 100Hz current ripple	5%
Output short circuit protection	Yes
Output overvoltage, open circuit protection	Yes, 40V, Non-Latching
Switching frequency	About 70kHz (depends on the input and output voltage)
Dimensions:	173 x 50 x 35 mm

This demo board intended for evaluation and testing purposes only, not for high volume and/or end product usage.

Warning!

Working with this board can cause serious bodily harm or death. Connecting the board to a source of line voltage will result in the presence of hazardous voltage throughout the primary side of system.

The board should only be handled by persons well aware of the dangers involved with working on live electrical equipment. Extreme care should be taken to protect against electric shock. Disconnect the board before attempting to make any changes to the system configuration. Always work with another person nearby who can offer assistance in case of an emergency. Wear safety glasses for eye protection.

The electrolytic capacitor carries a hazardous voltage for an extended time after the board is disconnected. Check the capacitor voltage before handling the board.

Board Layout and Connections

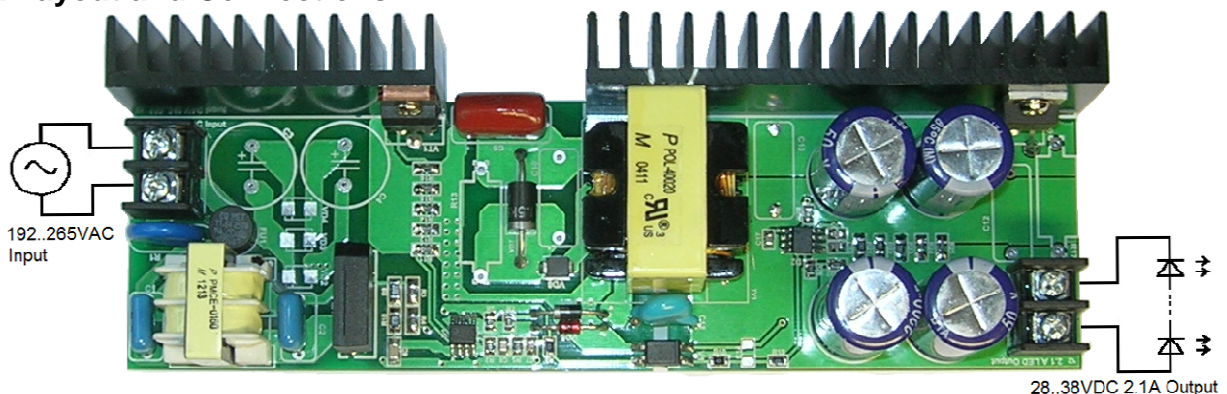



Schematic Diagram

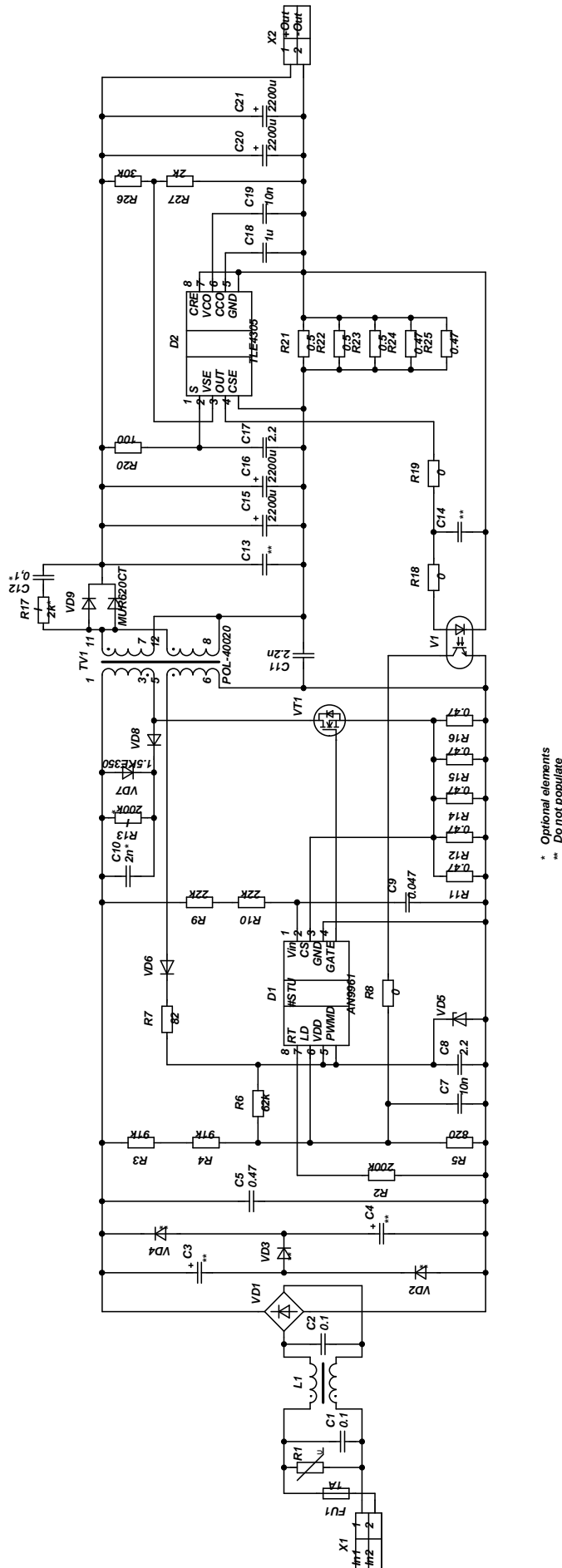

* Optional elements
 ** Do not populate



Connection Instructions

1. Carefully inspect the board for shipping damage, loose components, etc, before making connections.
2. Attach the board to the line and load as shown in the diagram. Be sure to check for correct polarity when connecting the LED string to avoid damage to the string. The board is short circuit and open circuit proof. The LED string voltage can be anything between 28 and 38V.
3. Energize the mains supply.

Principles of Operation

The topology of the AN9961DB2_v2 is in principal a peak-current mode flyback converter, operating with fixed off-time of 10 μ s. The current on the primary side is sensed via the sense resistors (R11..R16). If this current reaches the threshold (CS threshold of AN9961), the main switch (MOSFET VT1) is turned off. After the off-time (controlled by AN9961) expires, the main switch is turned on. The timing resistor R2 connected to RT determines the off-time of the driver IC.

Auxiliary components (VD6, R7, R9, R10, VD5, C8 and C9) used to power supply the controller.

To achieve a high power factor, the peak current is modulated in a way to follow the rectified mains input voltage. The input voltage is sensed via a resistive divider (R3, R4, R5) and this signal is mixed with the feedback signal via optocoupler V1. This modulation of the peak current modulates the input current to follow the input voltage and allows for a very good power factor.

The AN9961DB2_v2 allows for constant-current output control. For this control the TLE4305G is used on the secondary side to measure the output current and feedback the control signal via the optocoupler. The current is measured via the sense resistors (R21, R25) on the secondary side. To minimize the losses in the sense resistor, the TLE4305G allows for a very low sense voltage of 0.2 V. Additionally the TLE4305G measures the output voltage and switches to a constant-voltage regulation in case the output voltage exceeds the limit set by the resistive divider (R26, R27). The time constants for the cc and cv regulation loop can be set independently with the capacitors (C18, C19). It is necessary that the current regulation time constant is lower than the mains AC frequency. On the other side the voltage regulation must be fast, to avoid an overshoot at startup. The current regulation for a load is set for 2.1A.

Post-conduction oscillation across primary coil of pulse transformer TV1 and secondary side rectifier VD9 is substantial source of RF emission. Adding a snubber circuits (C10, R13, VD7 and R17, C12) can help significantly. In addition, this circuits is helpful to reduce the voltage stress at VT1 and VD9.



Typical Characteristics

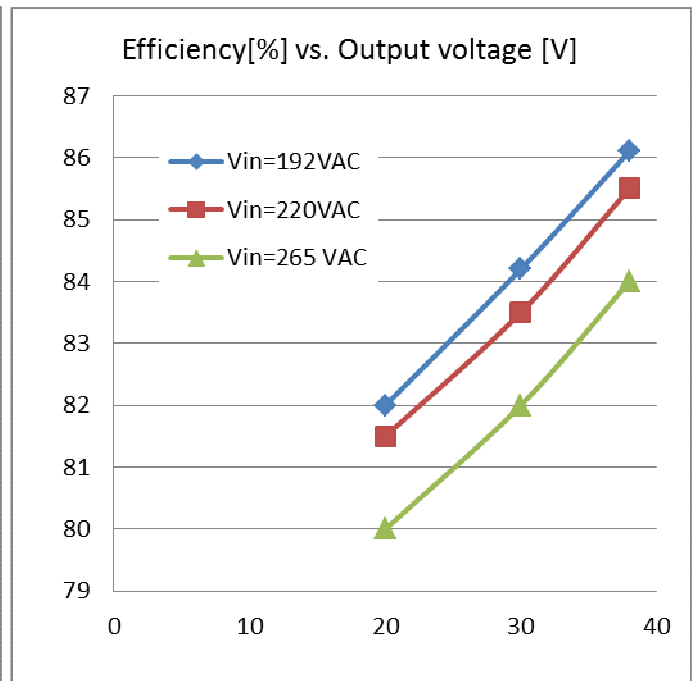
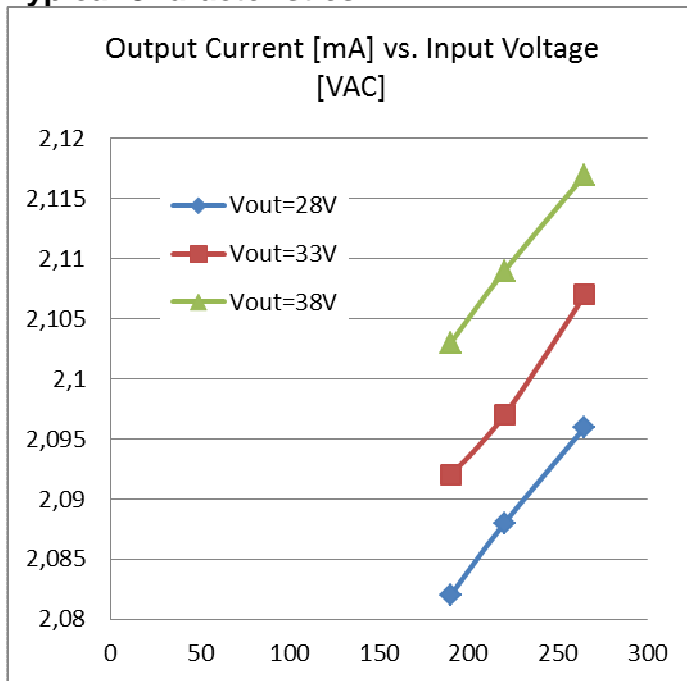



Waveforms (220VAC input and 35V load)

Drain voltage (overview)

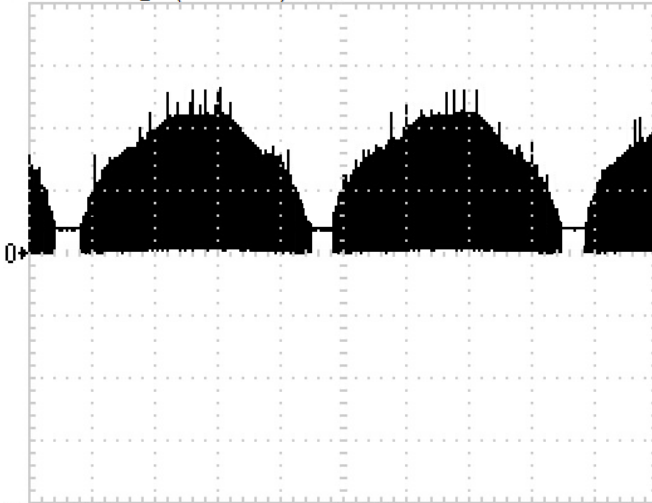

200V M 2.50ms

Drain voltage (Lo input voltage)

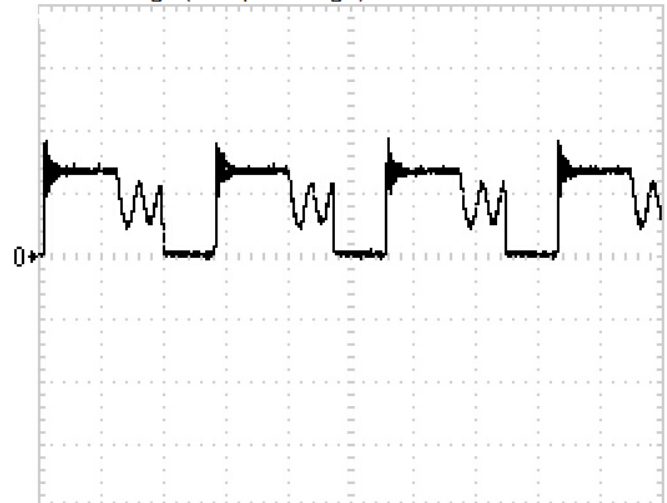

200V M 5.00µs

Drain voltage (Hi input voltage)



200V M 5.00µs

Input current

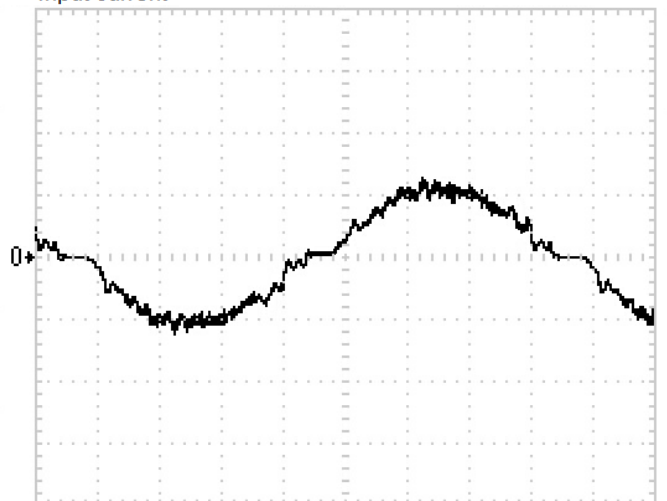

500mA M 2.50ms

LD pin of D1

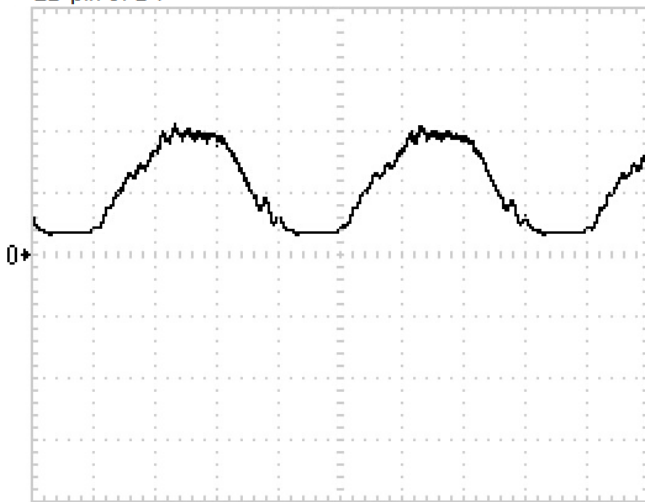

500mV M 2.50ms

Output current

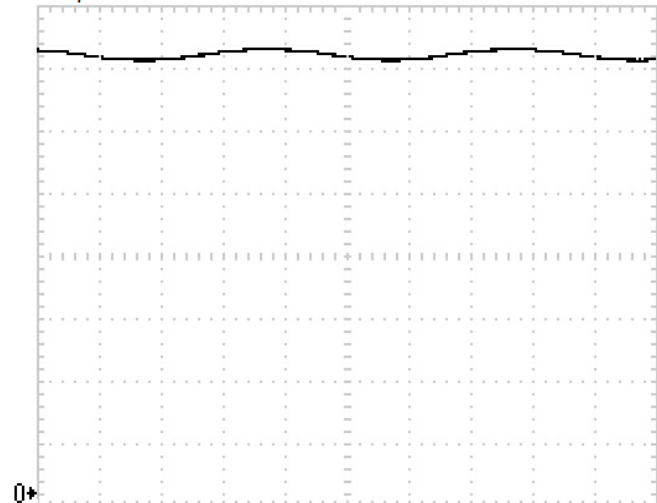

300mA M 2.50ms



PCB Layout

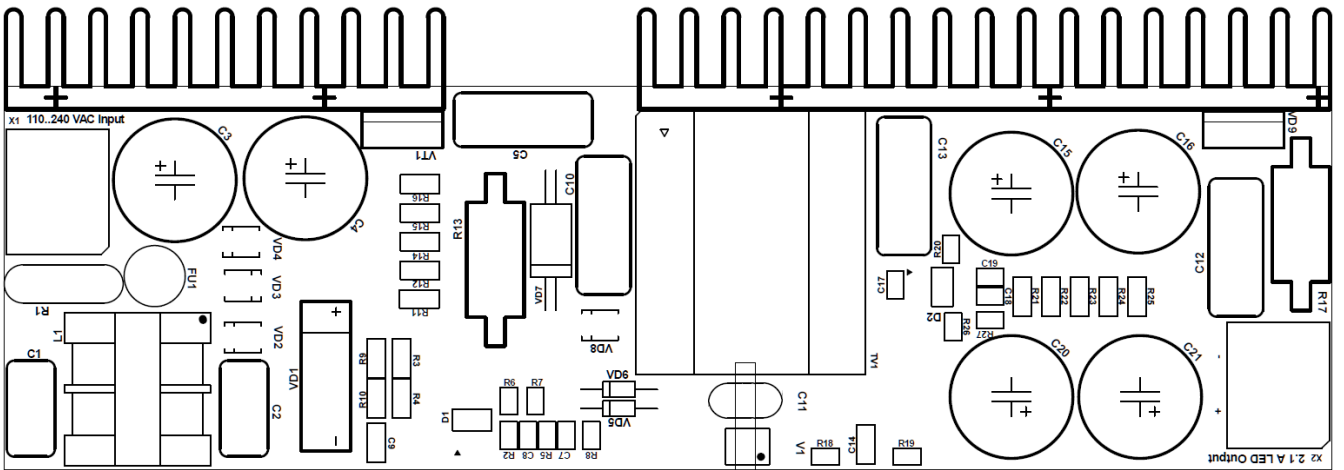
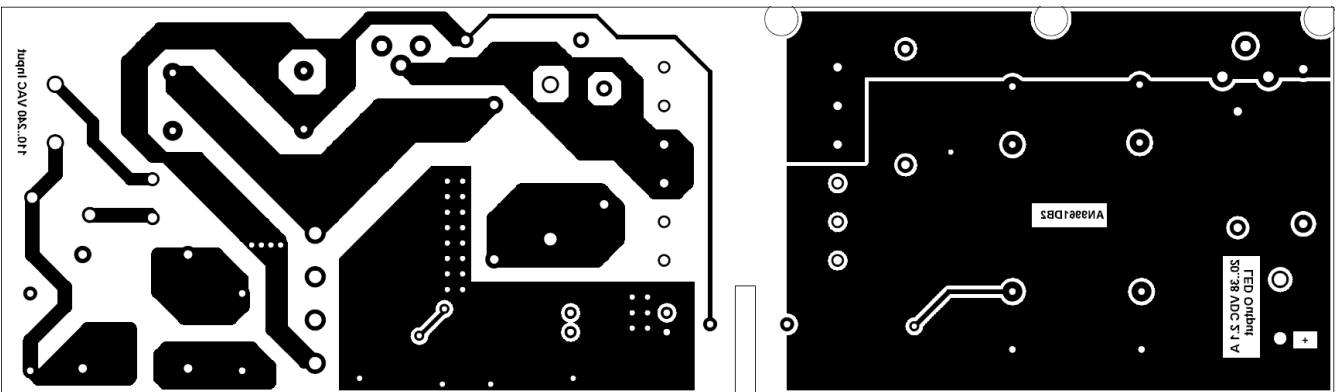
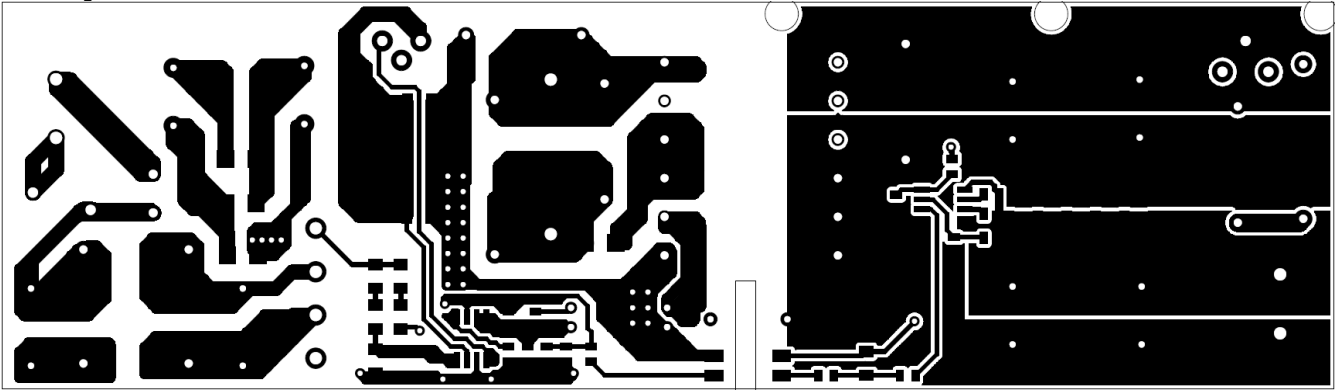



Bill of Materials

Qty	REF	Description	Manufacturer	Product Number
2	C1, C2	Cap MEF 0.1uF 400V	Shengxin	CL21-0.1uF-400V
2	C3, C4	Do not populate	Jamicon	TK 100uF 250V
2	C5	Cap MEF 0.47uF 400V	Shengxin	CL21-0.47uF-400V
2	C7, C19	Cap Cer X7R 0805 10nF 50V	-	-
2	C8, C17	Cap Cer X7R 0805 2.2uF 50V	-	-
1	C9	Cap Cer X7R 1210 0.047uF 630V	-	-
2	C10, C12	Optional	-	-
1	C11	Cap X1Y1 2.2nF 250V	Murata	DE1E3KX222M
1	C13	Do not populate	-	-
1	C14	Do not populate	-	-
4	C15, C16, C20, C21	Cap Alel ED Rad 2200uF 50V	Jamicon	TK 2200uF 50V
1	C18	Cap Cer X7R 0805 1uF 50V	-	-
1	DA1	IC LED Driver SO-8	Angstrom	AN9961
1	DA2	Current & Voltage Control IC	Infineon	TLE4305
1	FU1	Fuse 250VAC 1A	Conquer	MET1.0
1	L1	EMI Filter 16 mH 1.5A	Premier Magnetics	PMCE-0160
1	R1	Sur Absorber 14mm 275VAC	Epcos	B72214-S 271-K101
1	R2	Res 0805 5% 200kOhm	-	-
2	R3, R4	Res 1206 5% 91kOhm	-	-
1	R5	Res 0805 5% 820Ohm	-	-
1	R6	Res 0805 5% 62kOhm	-	-
1	R7	Res 0805 5% 820Ohm	-	-
1	R8	Res 0805 0Ohm	-	-
2	R9, R10	Res 1206 22kOhm	-	-
5	R11, R12, R14-R16	Res 1206 5% 0.47Ohm	-	-
2	R13, R17	Optional	-	-
2	R18, R19	Res 0805 0Ohm	-	-
1	R20	Res 0805 5% 100Ohm	-	-
3	R21-R23	Res 1206 1% 0.5Ohm	-	-
2	R24, R25	Res 1206 1% 0.47Ohm	-	-
1	R26	Res 0805 1% 30kOhm	-	-
1	R27	Res 0805 1% 2kOhm	-	-
1	TV1	Fly Back Transformer	Premier Magnetics	POL-40020
1	V1	OptoCoupler	Sharp	PC817
1	VD1	Rect Bridge 600V 4A	Vishay	KBL06
3	VD2-VD4	Do not populate	-	-
1	VD5	Diode Zener 8.2V 0.5W	Vishay	BZX55C8V2
1	VD6	Diode 100V 150mA DO-35	Diotec	1N4148
1	VD7	Diode TVS 350V 1.5W	STMicroelectronics	1.5KE350A
1	VD8	Diode Ultra-Fast 600V 1A SMB	ST Microelectronics	STTH2R06U
1	VD9	Diode Ultra-Fast 200V 6A TO-220	MCC	MUR620CT
1	VT1	Transistor N-MOS 800V 0.25Ohm	ST Microelectronics	STP18NM80
2	XT1, XT2	Terminal Block 250VAC 1A	Ningbo Xinya M&E	300-021-12