

Subject
SN03A Demo Board Manual

Board Model: LED24V1.5A-SN03A.00
 Doc. No.: OB_DOC_DBM_A_SN03A00



Key features:

- Single stage Flyback transition mode operation for LED Driver
- Constant Voltage / Constant current operation
- Meets minimum power factor requirement
- Short circuit protection and Over voltage protection
- Audio noise free
- Meet EN55015 & Part 18 EMI

Revision History

Revise Date	Version	Reason/Issue
2010-1-12	00	First issue

Contents Index

1.	Adapter Module Specification	- 4 -
1.1.	Input Characteristics	- 4 -
1.2.	Output Characteristics	- 4 -
1.3.	Performance Specifications	- 4 -
1.4.	Protection Features.....	- 4 -
1.5.	Environments	- 4 -
2.	LED Module Information	- 5 -
2.1.	Schematic	- 5 -
2.2.	Bill of material.....	- 6 -
2.3.	PCB Gerber File.....	- 8 -
2.4.	LED Module Snapshot	- 9 -
2.4.1.	Transformer Specification	- 9 -
2.4.2.	Transformer Winding data.....	- 9 -
2.5.	LED Module Snapshot	- 10 -
3.	Performance Evaluation.....	11
3.1.	Input Characteristics	11
3.1.1.	Standby power	11
3.1.2.	Efficiency	11
3.1.3.	Power Factor at Full load	12
3.2.	Output Characteristics	13
3.2.1.	Line Regulation & Load Regulation	13
3.2.2.	IV Curve	13
3.2.3.	Ripple & Noise	13
3.3.	EMI Test	15
3.3.1.	Conducted EMI Test.....	15
3.3.2.	Radiation EMI Test.....	16
4.	Over voltage Protection.....	16
5.	Other Important Waveform.....	17
5.1.	MOSFET Vds waveform @ no load/normal/output short.....	17
5.2.	MOSFET Voltage and current waveform @ 90Vac/265Vac.....	18

Figures Index

Fig. 1	No-load Input Power vs. Input Line Voltage	11
Fig. 2	Efficiency vs. Percent of Rated Output Power.....	12
Fig. 3	Power Factor Vs input voltage.....	12
Fig. 4	CC/CV Characteristics.....	13
Fig. 5	Measured ripple& noise waveform @90Vac/60Hz, no load.....	14
Fig. 6	Measured ripple& noise waveform @90Vac/60Hz, full load.....	14
Fig. 7	Measured ripple& noise waveform @264Vac/50Hz, no load.....	14
Fig. 8	Measured ripple& noise waveform @264Vac/50Hz, full load.....	14
Fig. 9	Vds waveform @264 Vac/50Hz,no load.....	17
Fig. 10	Normal, Vds waveform @265 Vac/50Hz, full load.....	17
Fig. 11	Output short, Vds waveform @265 Vac/50Hz.....	17
Fig. 12	Start, Vds waveform @90 Vac/60Hz, full load.....	18
Fig. 13	Start, Vds waveform @264 Vac/50Hz, full load.....	18
Fig. 14	Normal, Vds&Ids waveform @90 Vac/60Hz, full load.....	18
Fig. 15	Normal, Vds&Ids waveform @90 Vac/60Hz, full load.....	18
Fig. 16	Normal, Vds&Ids waveform @264 Vac/60Hz, full load.....	18
Fig. 17	Normal, Vds&Ids waveform @264 Vac/60Hz, full load.....	18

Tables Index

Table. 1	Standby power	11
Table. 2	Efficiency.....	11
Table. 3	Power factor.....	12
Table. 4	Line Regulation & Load Regulation.....	13
Table. 5	Ripple & Noise.....	13
Table. 6	OVP @ no load/full load.....	16
Table. 7	Vds_max @ Start/Normal/Output short.....	17

1. Adapter Module Specification

1.1. Input Characteristics

- AC input voltage rating 100Vac ~ 240Vac
- AC input voltage range 90Vac ~ 264Vac
- AC input frequency range 47Hz ~ 63Hz

1.2. Output Characteristics

- Output Voltage(Min.) 24.0V
- Output Voltage(Max) 26.0V
- load current(TYP) 1.5A

1.3. Performance Specifications

- Max. Output Power 36W
- Standby Power <0.5W @ 264V/50Hz, no load, 25°C
- Efficiency >80% @ Averaged. 25/50/75/100%Load, normal line, 25°C
- Line Regulation ±1% Max
- Load Regulation ±5% Max

1.4. Protection Features

- Short circuit Protection Output shut down with automatic recovery
- Over Voltage Protection Output shut down without automatic recovery

1.5. Environments

- Operating Temperature 0°C to +40°C
- Operating Humidity 20% to 90% R.H.
- Storage Temperature -40°C to +60°C
- Storage Humidity 0% to 95% R.H.

2. LED Module Information

2.1. Schematic

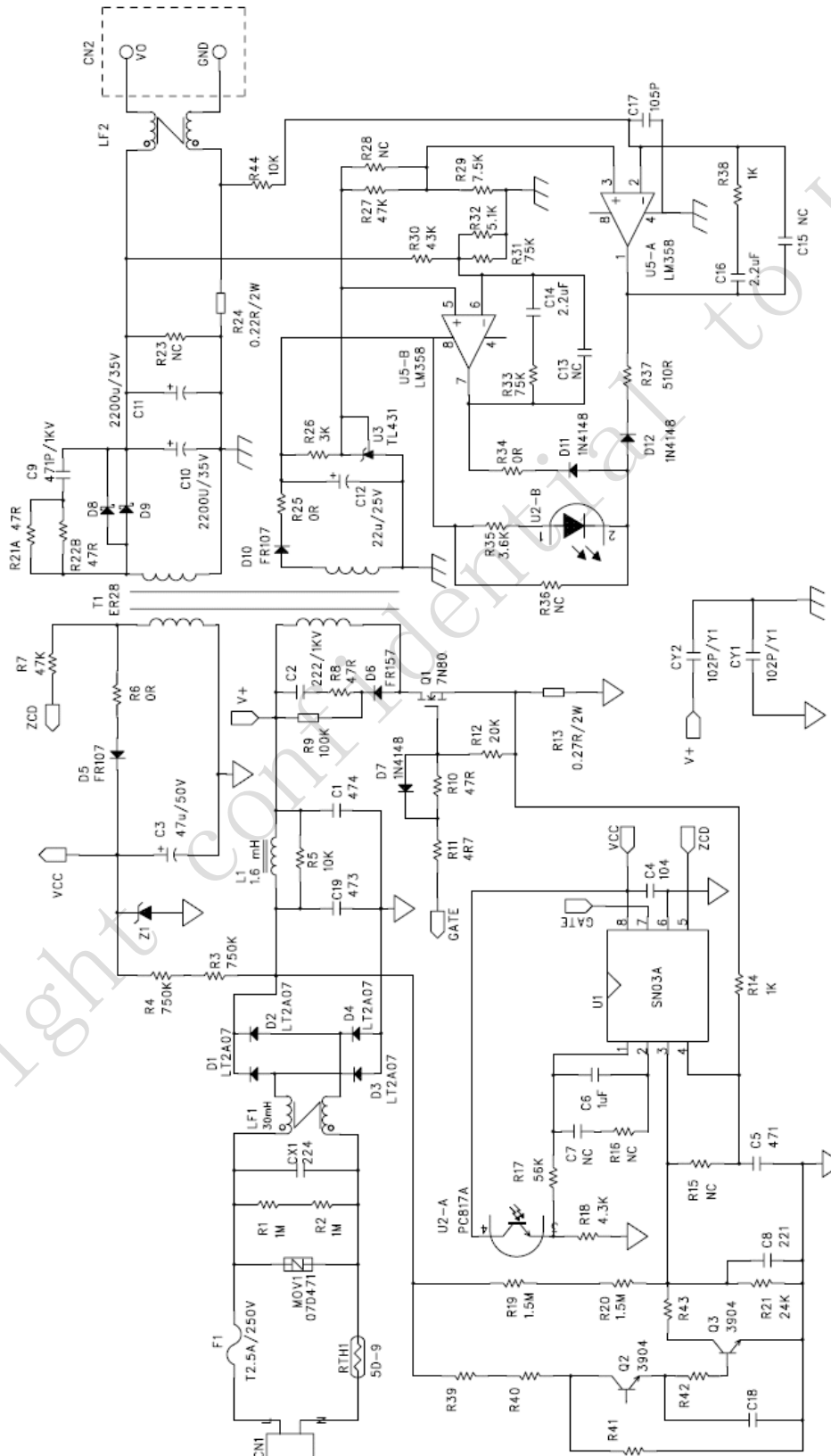

2.2. Bill of material

No.	Position	Description	Quantity	Remark
1	CN1	Input connector 3pin socket (patch 3.96mm)	1	
2	F1	FUSE, T2.5AH/250V	1	
3	MOV1	MOVR 07D471K	1	
4	T1	Transformer ER28 72:20:14:12 600uH	1	
5	LF1	Common choke, Core18.6*9.7*8.2mm, $\Phi 0.45 \times 60$ Ts*2, 30mH min	1	
6	LF2	Common choke, Core8*4*3mm, $\Phi 0.4 \times 10$ Ts*2, 100uH min	1	
7	L1	Choke, Core15.5*11.5*6.5mm, $\Phi 0.45 \times 150$ Ts, 1.6mH MIN	1	
8	CX1	X2-CAP, 0.22uF, +/-20%, 275Vac	1	
9	CY1, CY2	Y1-CAP, 1000PF, +/-20%, 250Vac	2	
10	C19	MPP 0.047uF 630V	1	
11	C1	MPP 0.47uF 630V	1	
12	C2	C.C 222 1KV Dip	1	
13	C3	E.C 47uF 50V DIP	1	
14	C4	SMD 104PF 50V 0805	1	
15	C5	SMD 470PF 50V 0805	1	
16	C6	SMD 1uF 50V 0805	1	
17	C7, C13, C15, C18	NC		
18	C8	SMD 220PF 50V 0805	1	
19	C9	C.C 470PF 1KV DIP	1	
20	C10, C11	E.C 2200uF 35V Low ESR	2	
21	C14, C16	SMD 2.2uF 50V 0805	2	
22	C17	SMD 1uF 50V 0805	1	
23	R1, R2	SMD 1M 5% 1206	2	
24	R3, R4	SMD 750K 5% 0805	2	
25	R5	SMD 10K 5% 0805	1	
26	R6	SMD 0R 5% 1206	1	
27	R7	SMD 47K 5% 1206	1	
28	R8	SMD 47R 5% 1206	1	
29	R9	MOR 100K 5% 1W DIP	1	
30	R10	SMD 47R 5% 0805	1	
31	R11	SMD 4.7R 5% 0805	1	
32	R12	SMD 20K 5% 0805	1	
33	R13	CFR 0.27R 5% 2W	1	
34	R14	SMD 1K 5% 0805	1	
35	R15, R16, R23, R28	NC		
36	R17	SMD 56K 5% 0805	1	
37	R18	SMD 4.3K 5% 0805	1	
38	R19, R20	SMD 1.5M 5% 1206	2	
39	R21	SMD 24K 5% 0805	1	
40	R21A, R22B	SMD 47R 5% 1206	2	

41	R24	CFR 0.22R 1% 2W	1	
42	R25,R34	SMD 0R 5% 0805	2	
43	R26	SMD 3K 5% 0805	1	
44	R27	SMD 47K 5% 0805	1	
45	R29	SMD 7.5K 5% 0805	1	
46	R30	SMD 43K 5% 0805	1	
47	R31	SMD 75K 5% 0805	1	
48	R32	SMD 5.1K 5% 0805	1	
49	R33	SMD 51K 5% 0805	1	
50	R35	SMD 3.6K 5% 0805		
51	R37	SMD 510R 5% 0805	1	
52	R38	SMD 1K 5% 0805	1	
53	R36,R39,R40,R41 ,R42,R43,Q2,Q3	NC		
54	Z1	SMD Zener Diode 27V 1/2W	1	
55	D1,D2,D3, D4	Diode LT2A07 DO-15	4	
56	D5	Diode FR157 DO-15	1	
57	D6,D10	Diode FR107 DO-41	2	
58	D7,D11,D12	SMD Diode 1N4148 Mini-melf	3	
59	U1	PFC controller SN03A SOP8	1	
60	U2	Photo coupler 817A	1	
61	U3	TL431	1	
62	U5	Dual Operation amplifiers LM358	1	
63	RTH1	5D-9	1	
64	Q1	Mosfet FQP7N80C 7A800V	1	
65	HS3	Heat Sink 50mm(L)*30mm(H),1.2(mm)T,AL	1	
66	Screw	For Q1, 3*6 Zine	1	
67	NUT	For Q1, BRS, HEX, NONE, M3, 5.5*2.3	1	
68	PCB	FR-4, 115mm(L)*50mm(W)	1	

2.3. PCB Gerber File

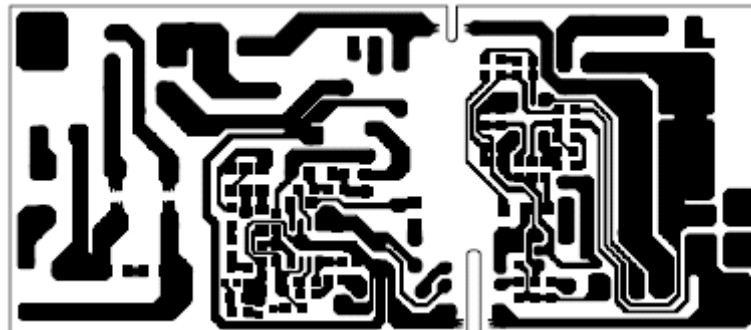

Bottom

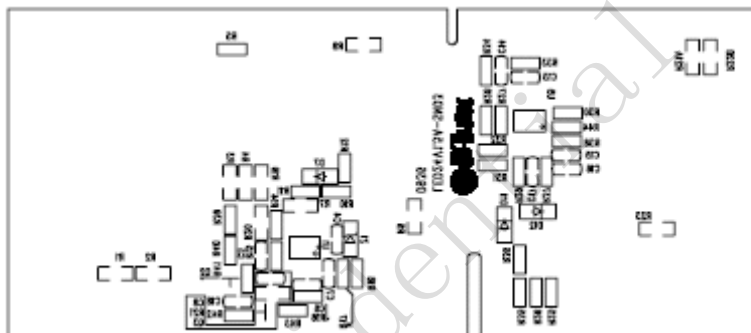

Bottom

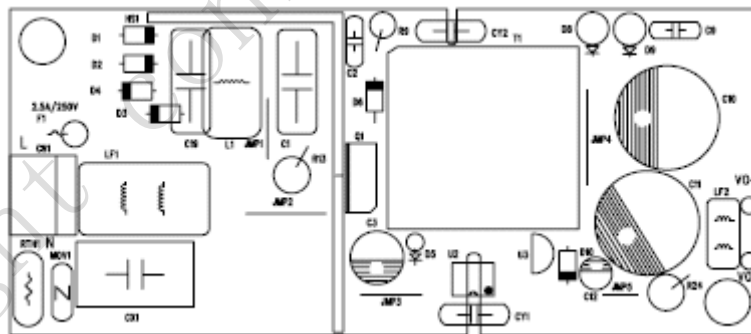

Top

2.4. LED Module Snapshot

2.4.1. Transformer Specification

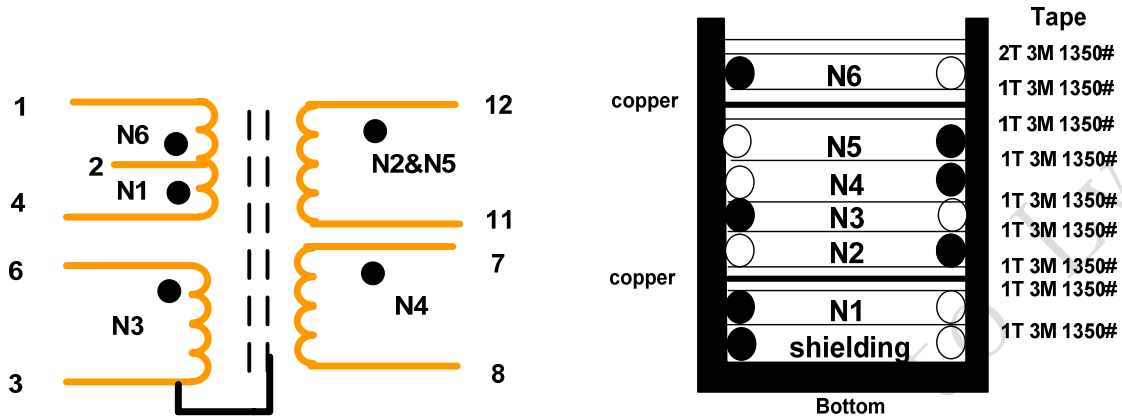

Note:

- 1) Bobbin: ER28 (12Pin)
- 2) Core material: PC40 (TDK).
- 3) $L(1-4) = 600\mu\text{H} \pm 5\%$ (10KHz, 1V, 25°C)

2.4.2. Transformer Winding data

Winging	Material	Start	Turns	Finish
Shielding	0.15Φ*3 2UEW	3	29	NC
TAPE	TAPE W=16.5mm (Y)		1	
N1	0.41Φ*1 2UEW	4	36	2
TAPE	TAPE W=16.5mm (Y)		1	
Copper	W=16.5mm	3	1.2	NC
TAPE	TAPE W=16.5mm (Y)		1	
N2	0.5Φ*1 triple insulated wire	12	23	11
TAPE	TAPE W=16.5mm (Y)		1	
N3	0.16Φ*5 2UEW	6	16	3
TAPE	TAPE W=16.5mm (Y)		1	
N4	0.2Φ*2 triple insulated wire	7	14	8
TAPE	TAPE W=16.5mm (Y)		1	
N5	0.5Φ*1 triple insulated wire	12	23	11
TAPE	TAPE W=16.5mm (Y)		1	
Copper	W=16.5mm	3	1.2	NC
TAPE	TAPE W=16.5mm (Y)		1	
N6	0.41Φ*1 2UEW	2	36	1
TAPE	TAPE W=16.5mm (Y)		2	
External Copper	External Copper W=16.5mm	3	1.2	

2.5. LED Module Snapshot

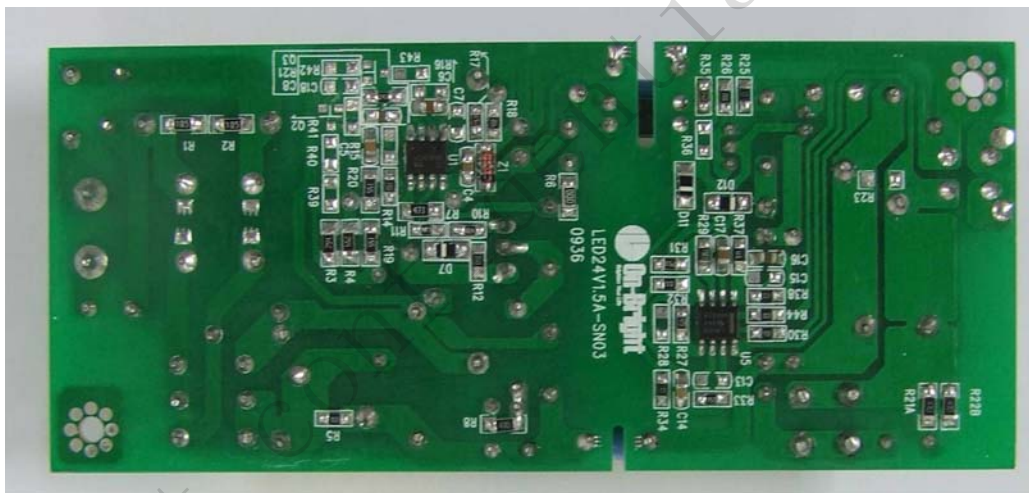

3. Performance Evaluation

This session presents the test results of LED36W module up to date. Results on inrush current and safety test are not included and will be added when they become available.

Overall, the module meets design specifications.

All data was measurement at PCB end.

Test Equipments

Item	Vender	Module
AC Source	WEST	WEW1010
Digital Power Meter	YOKOGAWA	WT210
Electrical Load	Prodigit	3315C
Oscilloscope	LeCroy	WS424
Multimeter	VICTORY	VC9807A

3.1. Input Characteristics

3.1.1. Standby power

Table. 1 Standby power

Input voltage	Pin(W)	Vo(V)	Specification	Test result
90Vac/60Hz	0.238	24.69	<0.5W	Pass
115Vac/60Hz	0.266	24.69		
230Vac/50Hz	0.355	24.69		
264Vac/50Hz	0.401	24.69		

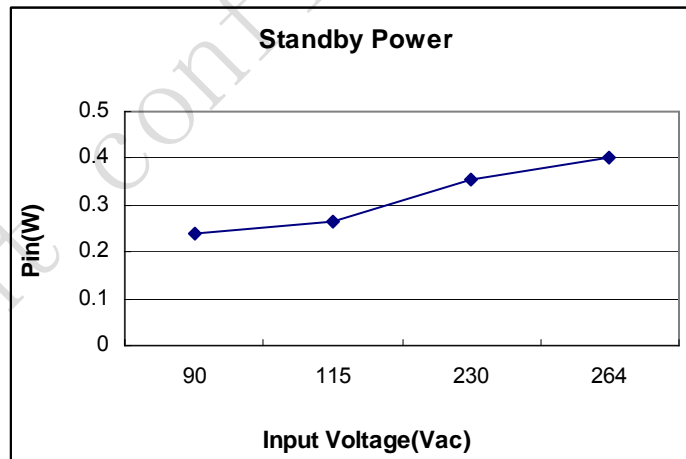

Fig. 1 No-load Input Power vs. Input Line Voltage

3.1.2. Efficiency

Table. 2 Efficiency

Input voltage	25%	50%	75%	100%	Aver. Eff.	Spec.
90Vac/60Hz	85.93	85.91	82.48	80.06	83.59	>80%
115Vac/60Hz	85.77	86.81	84.19	82.28	84.76	
230Vac/50Hz	79.72	85.73	85.55	84.76	83.94	
264Vac/50Hz	76.66	84.68	84.92	84.40	82.66	

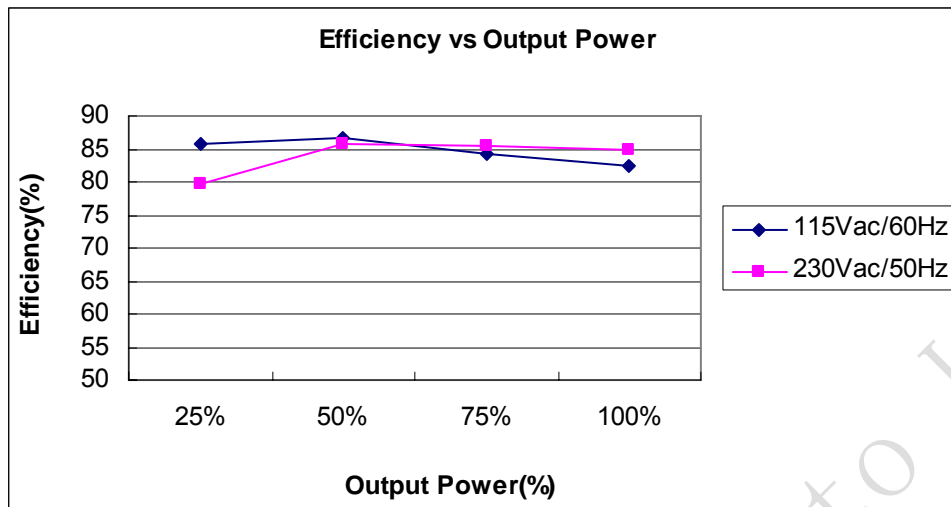

Fig. 2 Efficiency vs. Percent of Rated Output Power

3.1.3. Power Factor at Full load

Table. 3 Power factor

Input voltage	PF	Spec.
90Vac/60HZ	0.983	>0.9
115Vac/60HZ	0.982	
230Vac/50HZ	0.945	
265Vac/50HZ	0.919	

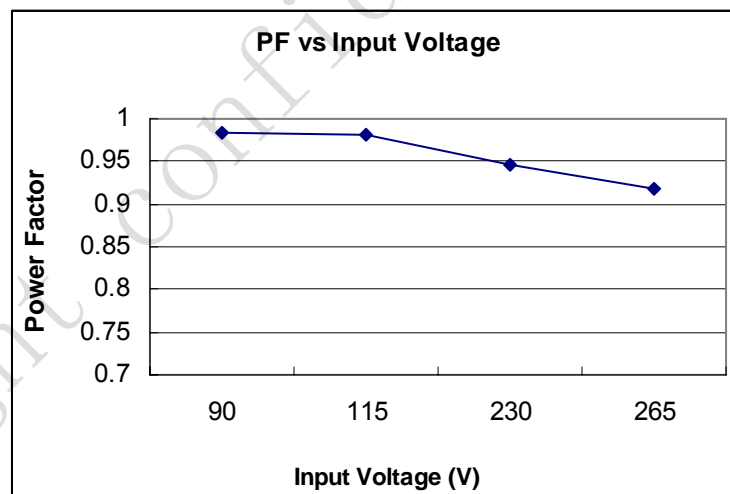

Fig. 3 Power Factor Vs input voltage

3.2. Output Characteristics

3.2.1. Line Regulation & Load Regulation

Table. 4 Line Regulation & Load Regulation

Input voltage	No load	Half load	Full load	Specification	Test result
90Vac/60Hz	24.69	24.49	24.28		
115Vac/60Hz	24.69	24.49	24.28		
230Vac/50Hz	24.69	24.49	24.28		
264Vac/50Hz	24.69	24.49	24.28		
Line Regulation	0.00%			1%	Pass
Load Regulation	1.708%			5%	Pass

3.2.2. IV Curve

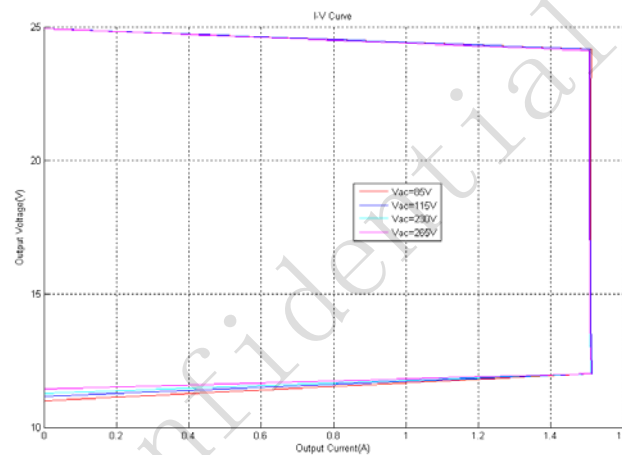

Fig. 4 CC/CV Characteristics

3.2.3. Ripple & Noise

Table. 5 Ripple & Noise

Input voltage	R&N (mV)		
	No load	Full load	Remark
90Vac/60Hz	55mV	957mV	Fig. 5,6
115Vac/60Hz	58mV	958mV	
230Vac/50Hz	31mV	1030mV	
264Vac/50Hz	36mV	1030mV	Fig. 7,8

Note: Ripple & noise were measured at DC CABLE end with a 0.1uF/100V ceramic cap connected in parallel with a 10uF/50V Electrolytic cap. Bandwidth was limited to 20MHz.

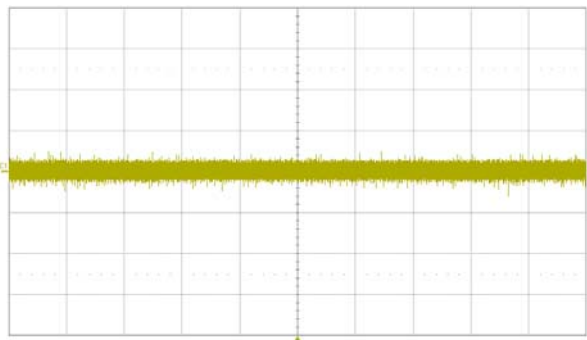

Fig. 5 Measured ripple & noise waveform @90Vac/60Hz, no load

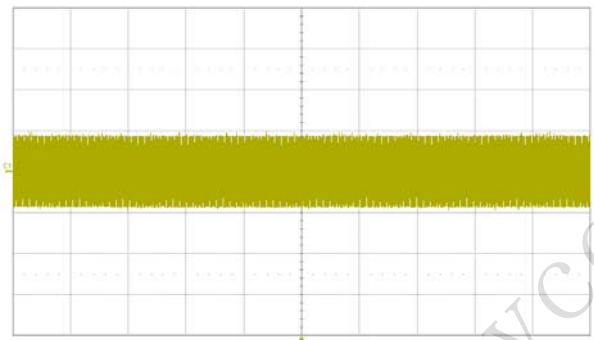

Fig. 6 Measured ripple & noise waveform @90Vac/60Hz, full load

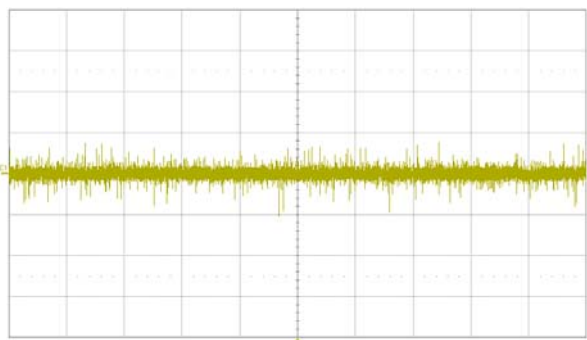

Fig. 7 Measured ripple & noise waveform @264Vac/50Hz, no load

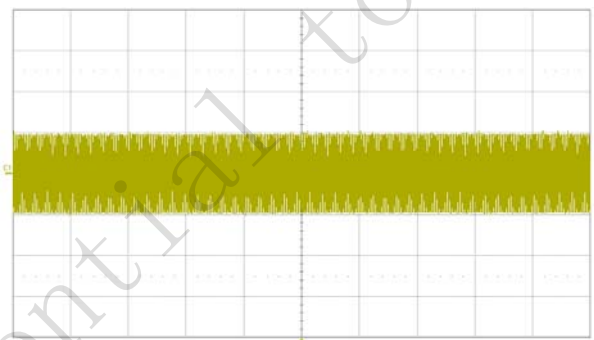

Fig. 8 Measured ripple & noise waveform @264Vac/50Hz, full load

3.3. EMI Test

The Power supply passed EN55015 Class B & FCC PART 18 EMI requirement with more than 6dB margin

3.3.1. Conducted EMI Test

EN55015 CLASS B @ full load report

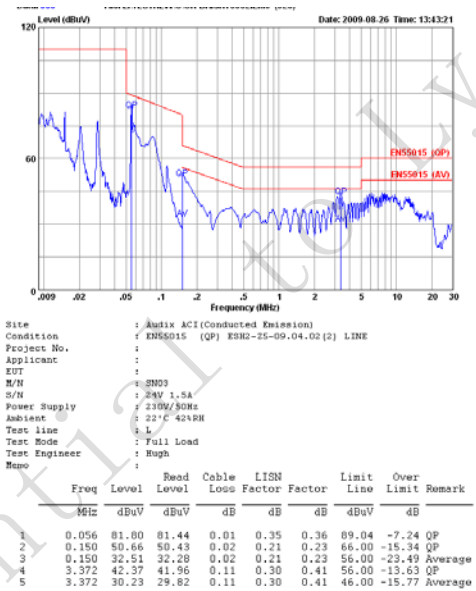
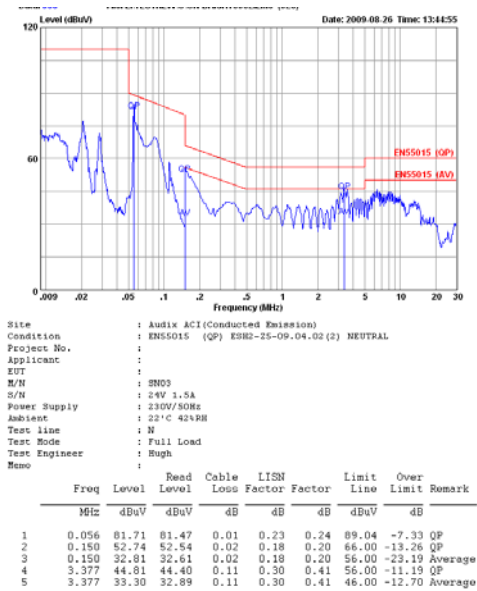

FCC PART 18 @ full load report



3.3.2. Radiation EMI Test

EN55015 CLASS B @ full load report

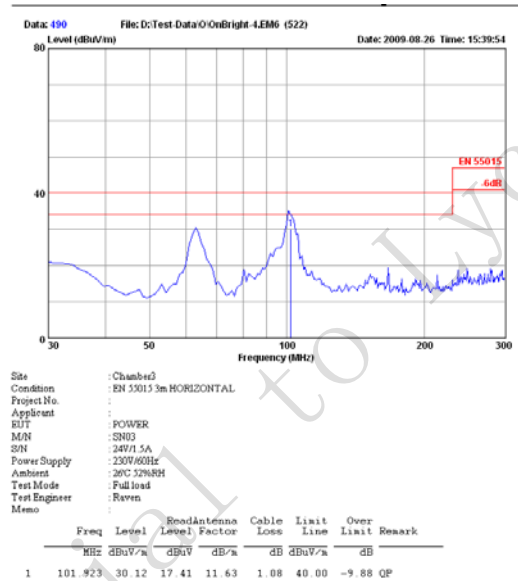
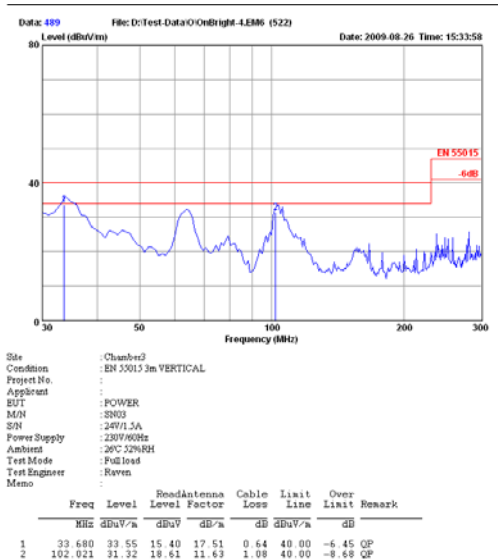

FCC PART 18 @ full load report

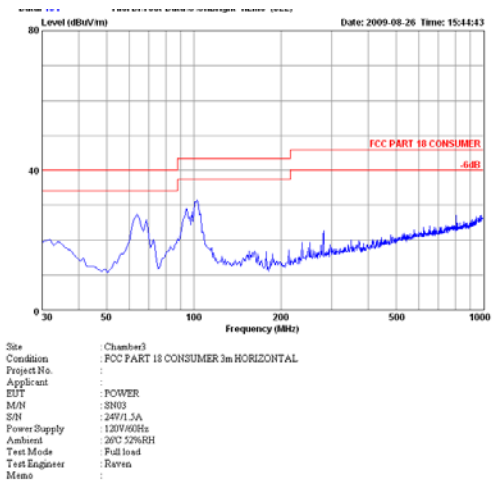
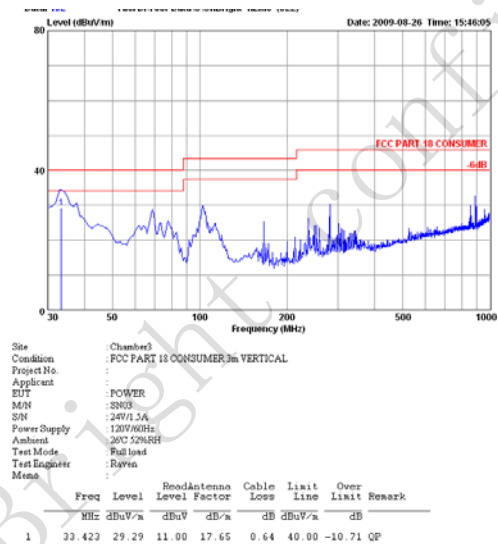

4. Over voltage Protection

Table. 6 OVP @ no load/full load

Input	OVP Protection
115Vac/60Hz	OK
230Vac/50Hz	OK

5. Other Important Waveform

5.1. MOSFET Vds waveform @ no load/normal/output short

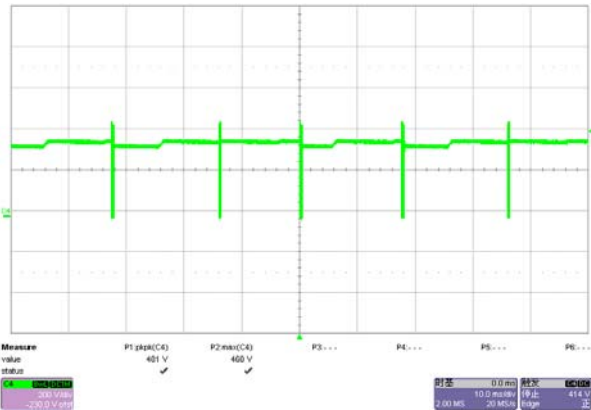

Fig. 9 Vds waveform @264 Vac/50Hz, no load

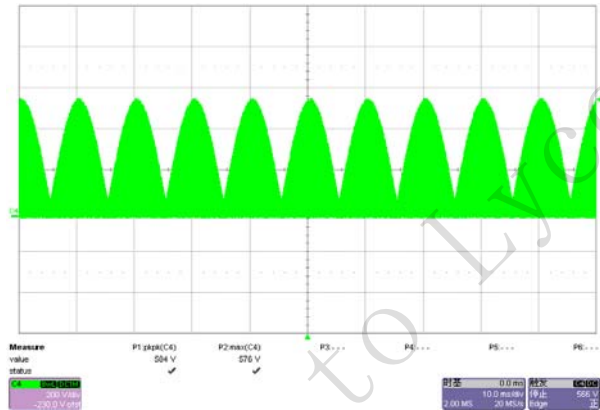

Fig. 10 Normal, Vds waveform @265 Vac/50Hz, full load

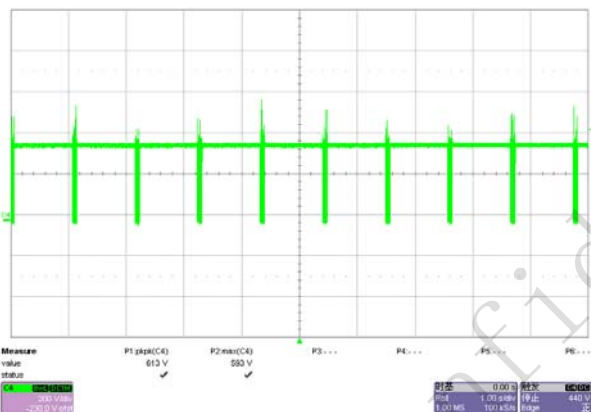

Fig. 11 Output short, Vds waveform @265 Vac/50Hz

Table. 7 Vds_max @ Start/Normal/Output short

Input	Vds_max(V)
264Vac/50Hz @Start	481
264Vac/50Hz @ Normal (Full load)	584
264Vac/50Hz @ Output short	613

5.2. MOSFET Voltage and current waveform @ 90Vac/265Vac

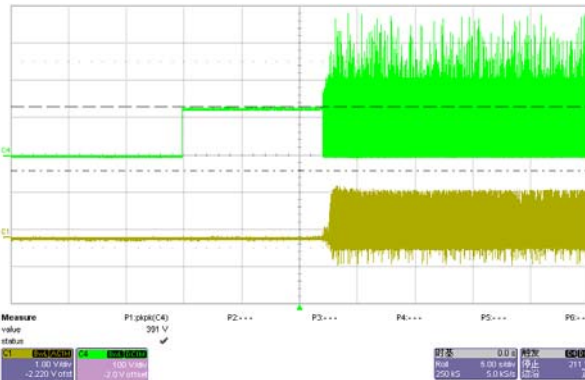

Fig. 12 Start, Vds waveform@90 Vac/60Hz, full load

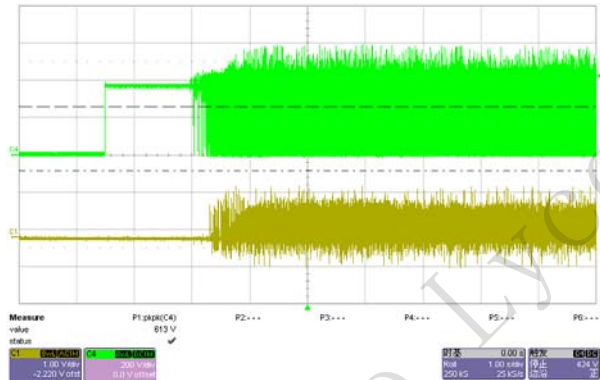

Fig. 13 Start, Vds waveform@264 Vac/50Hz, full load

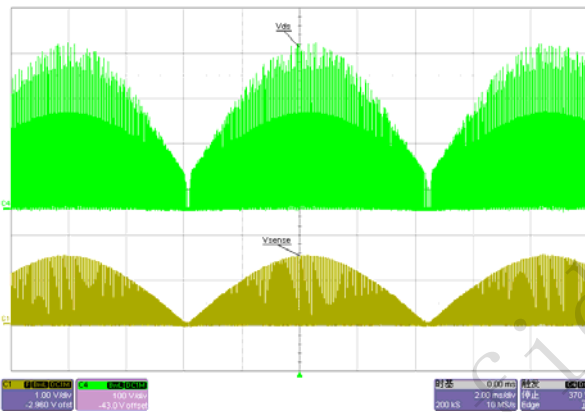

Fig. 14 Normal, Vds&Ids waveform@90 Vac/60Hz, full load

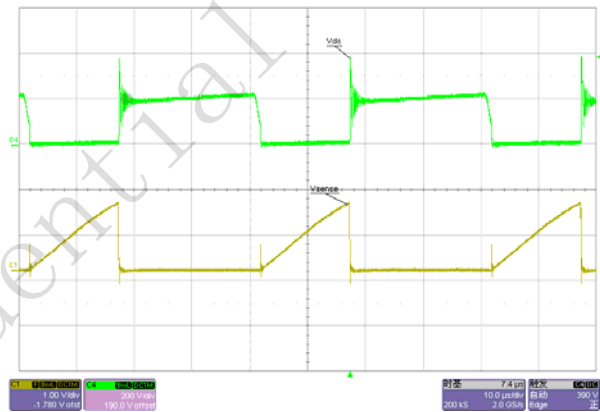

Fig. 15 Normal, Vds&Ids waveform@90 Vac/60Hz, full load

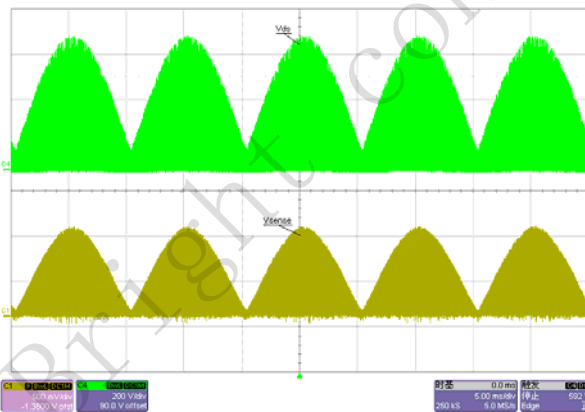

Fig. 16 Normal, Vds&Ids waveform@264 Vac/60Hz, full load

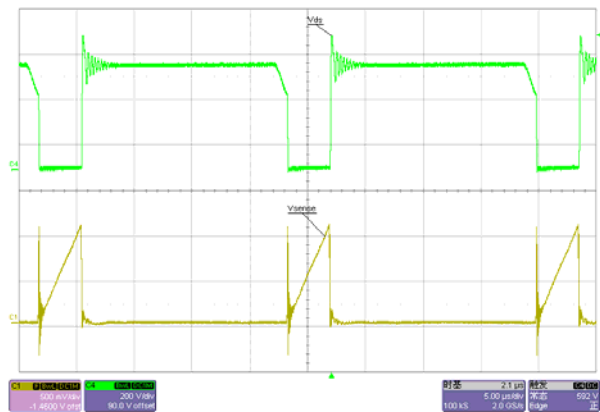

Fig. 17 Normal, Vds&Ids waveform@264 Vac/60Hz, full load

Disclaimer

On-Bright Electronics reserves the right to make corrections, modifications, enhancements, improvements, and other changes to its documents, products and services at any time and to discontinue any product or service without notice. Customers should obtain the latest relevant information before placing orders and should verify that such information is current and complete.

This document is under copy right protection. Non of any part of document could be reproduced, modified without prior written approval from On-Bright Electronics.