



## 4:1 Intermediate Bus Converter Module: Up to 650 W Output IB054Q120T53N1-00



Size:  
2.30 x 1.45 x 0.41 in  
58,4 x 36,8 x 10,5 mm

### Applications

- Enterprise networks
- Optical access networks
- Storage networks
- Automated test equipment

### Features

- Input: 36 – 60 Vdc
- Output: 12 Vdc at 48 Vin
- Output current: up to 53 A
- Output power: up to 650 W <sup>[A]</sup>
- 1,500 Vdc isolation
- 98% peak efficiency
- Low profile: 0.41" height above board
- Industry standard 1/4 Brick pinout
- Sine Amplitude Converter
- Low noise 1 MHz ZVS/ZCS

<sup>[A]</sup> For lower power applications see 300 W model IB054E120T32N1-00 or 500 W model IB054E120T40N1-00

### Product Overview

The Intermediate Bus Converter (IBC) Module is a very efficient, low profile, isolated, fixed ratio converter for power system applications in enterprise and optical access networks. Rated at up to 477 W from 36 Vin and up to 650 W from 50 to 60 Vin, the IBC conforms to an industry standard quarter-brick footprint while supplying power greatly exceeding competitive quarter-bricks. Its leading efficiency enables full load operation at 55°C with only 200 LFM airflow. Its small cross section facilitates unimpeded airflow — above and below its thin body — to minimize the temperature rise of downstream components.

### Absolute Maximum Ratings

	Min	Max	Unit	Notes
Input voltage (+In to -In)				
Operating		60	Vdc	Continuous
		75	Vdc	<100 mS
Input voltage slew rate		5	V/μs	
EN to -IN	-0.5	20	Vdc	
Output voltage (+Out to -Out)	-0.5	17.2	Vdc	18.75 V for 100 mS
Output current		64	A	Pout ≤ 650 W
Dielectric withstand (input to output)	2,250		Vdc	1 min.
Temperature				
Operating junction	-40	125	°C	Hottest Semiconductor
Storage	-55	125	°C	

# PRELIMINARY DATA SHEET

## SPECIFICATIONS

All specifications valid at 48 V<sub>IN</sub>, 100% rated load and 25°C ambient, unless otherwise indicated.

Electrical Characteristics						
Attribute	Symbol	Conditions / Notes	Min	Typ	Max	Unit
<b>INPUT</b> (Operating from DC input source)						
Operating input voltage			36	48	60	Vdc
Operating input surge withstand		<100 mS			75	Vdc
Operating input dV/dt					5	V/us
Undervoltage protection						
Turn-on			31		36	Vdc
Turn-off			29		34	Vdc
Turn-on/Turn-off hysteresis			2			Vdc
Time constant					7	µs
Overvoltage protection						
Turn-off			76		79.5	Vdc
Turn-on			75		78	Vdc
Time constant					4	µs
Turn ON delay						
Start up inhibit		V <sub>IN</sub> reaching turn-on voltage to enable function operational, see Figure 6			15	ms
Turn-on delay		Enable to 90% V <sub>OUT</sub> ; pre-applied V <sub>IN</sub> , see Figure 7			50	µs
Output voltage rise time		From 10% to 90% V <sub>out</sub> , 10% load			50	µs
Restart turn-on delay					2000	ms
No Load power dissipation						
Enabled				3.3	3.7	W
Disabled				0.12	0.15	W
Input current					13.5	A
Inrush current overshoot		Using test circuit in Figure 21		30		A
Input reflected ripple current		At max power; Using test circuit in Figure 22			540	mArms
Peak short circuit input current					37	A
Repetitive short circuit peak current					37	A
Internal input capacitance				13.2		µF
Internal input inductance				5		nH
Recommended external input capacitance		200 nH maximum source inductance	47		470	µF
<b>OUTPUT</b>						
DC Output voltage band		No load, over Vin range	9.0	12.0	15.0	V
Output power [a]						
36-60 V <sub>IN</sub>			0		480	W
48-60 V <sub>IN</sub>			0		600	W
50-60 V <sub>IN</sub>			0		650	W
Output current		P ≤ 650 W			53	A
Output start up load		of I <sub>out</sub> max, maximum output capacitance			15	%
Effective output resistance				4.7		mΩ
Line regulation (K factor)		V <sub>OUT</sub> = K • V <sub>IN</sub> @ no load	0.245	0.250	0.252	
Current share accuracy		Full power operation; See Parallel Operation on page 11; up to 3 units			10	%

[a] Does not exceed IPC-9592 derating guidelines. At 70°C ambient, full power operation may exceed IPC-9592 guidelines, but does not exceed component ratings, does not activate OTP and does not compromise reliability.

# PRELIMINARY DATA SHEET

## SPECIFICATIONS (CONT.)

All specifications valid at 48 V<sub>IN</sub>, 100% rated load and 25°C ambient, unless otherwise indicated.

Electrical Characteristics (Continued)						
Attribute	Symbol	Conditions / Notes	Min	Typ	Max	Unit
<b>OUTPUT</b> (Continued)						
Efficiency						
50% load		See Figure 1,2 and 3	97.4	97.6		%
Full load		See Figure 1,2 and 3	96.7	97.0		%
Internal output inductance				1.6		nH
Internal output capacitance				75		μF
Load capacitance		Nominal load	0		3,000	μF
Output OVP set point		Module will shutdown	16.2		17.2	Vdc
Output voltage ripple		20 MHz bandwidth, using test circuit in Figure 23		60	150	mVp-p
Output Overload protection threshold		Of I <sub>out</sub> max., will not shutdown when started into max C <sub>out</sub> ; and 15% load Auto restart with duty cycle <10%	105		150	%
Over current protection time constant					5	ms
Short circuit current response time					1.5	μs
Switching frequency				1.0		MHz
Transient Response						
Voltage overshoot		25% load step; 1A/μS; See Figures 13 & 14			100	mV
Response time		See Figures 13 & 14		1		μS
V <sub>IN</sub> step		5 V step in 1 μS within V <sub>in</sub> operating range			1.25	V
Pre-bias voltage		Unit will start up into pre-bias voltage on output	0		12	Vdc

General Characteristics <span style="float: right;"><i>Conditions: 25°C case, 75% rated load and specified input voltage range unless otherwise specified.</i></span>						
Attribute	Symbol	Conditions / Notes	Min	Typ	Max	Unit
MTBF		Calculated per Telcordia SR-332, 40°C	1.0			Mhrs
Service life		Calculated at 30°C	7			Years
Over temperature shut down		T <sub>J</sub> ; Converter will reset when over temperature condition is removed	125	130	135	°C
Dielectric withstand		Input to output	2,250			Vdc
Insulation resistance		Input to output		30		MΩ
Mechanical						
Weight				1.38 / 39.1		oz/g
Length				2.30 / 58.4		in/mm
Width				1.45 / 22.9		in/mm
Height above customer board				0.41 / 10.5		in/mm
Clearance to customer board		From lowest component on IBC	0.12/0.30			in/mm
Agency approvals (pending)		UL/CSA 60950, EN60950 Low voltage directive		cTUVus CE		
Altitude, operating		Derate operating temp 1°C per 1,000 feet above sea level	-500		10,000	Feet
Relative humidity, Operating		Non condensing	10		90	%
RoHS compliance		Compatible with RoHS directive 2002/95/EC				

# PRELIMINARY DATA SHEET

## SPECIFICATIONS (CONT.)

Control & Interface Specifications						
Attribute	Symbol	Conditions / Notes	Min	Typ	Max	Unit
Enable		Referenced to -IN				
Module enable threshold			0.8			Vdc
Module enable current		$V_{EN} = 0.8 V$		130	200	$\mu A$
Module disable threshold					2.4	Vdc
Module disable current		$V_{EN} = 2.4 V$			10	$\mu A$
Disable hysteresis				500		mV
Enable pin open circuit voltage				2.4	3.0	Vdc
EN to -IN resistance		Open circuit		35		k $\Omega$

IPC-9592A, Based on Class II Category 2 the following detail is applicable. – Pre-conditioning required

Environmental Qualification		
Test Description	Test Detail	Quantity Tested
5.2.3 HALT (Highly Accelerated Life testing)	Low Temp	3
	High Temp	3
	Rapid Thermal Cycling	3
	6 DOF Random Vibration Test	3
	Input Voltage Test	3
	Output Load Test	3
	Combined Stresses Test	3
5.2.4 THB (Temp. Humidity Bias)	(72 hr presoak required) 1000 hrs – Continuous Bias	30
5.2.5 HTOB (High Temp. Operating Bias)	Power cycle - On 42 minutes Off 1 minute, On 1 minute, Off 1 minute, On 1 minute, Off 1 minute, On 1 minute, Off 1 minute, On 1 minute, Off 10 minutes. Alternating between maximum and minimum operating Voltage every hour.	30
5.2.6 TC (Temp. Cycling)	700 cycles , 30 minute dwell at each extreme – 20C minimum ramp rate.	30
5.2.7 Power Cycling	Reference IPC-9592A	3
5.2.8 – 5.2.13 Shock and Vibration	Random Vibration – Operating IEC 60068-2-64 (normal operation vibration)	3
	Random Vibration Non-operating (transportation) IEC 60068-2-64	3
	Shock Operating - normal operation shock IEC 60068-2-27	3
	Free fall - IEC 60068-2-32	3
	Drop Test 1 full shipping container (box)	12
5.2.14 Other Environmental Tests	5.2.14.1 Corrosion Resistance – Not required	N/A
	5.2.14.2 Dust Resistance – Unpotted class II GR-1274-CORE	3
	5.2.14.3 SMT Attachment Reliability IPC-9701 - J-STD-002	3
	5.2.14.4 Through Hole solderability – J-STD-002	5
ESD Classification Testing	Sample size assumes CDM testing	12
<b>Total Quantity</b>		<b>161</b>

# PRELIMINARY DATA SHEET

## SPECIFICATIONS (CONT.)

### WAVEFORMS

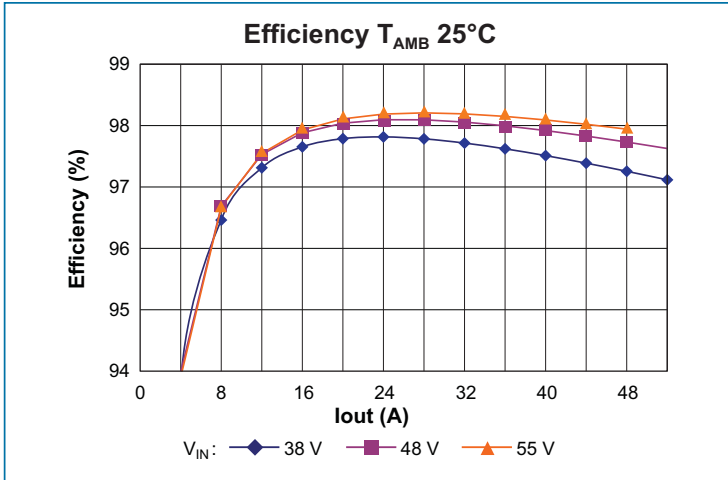

Figure 1 — Efficiency vs. output current, 25°C ambient

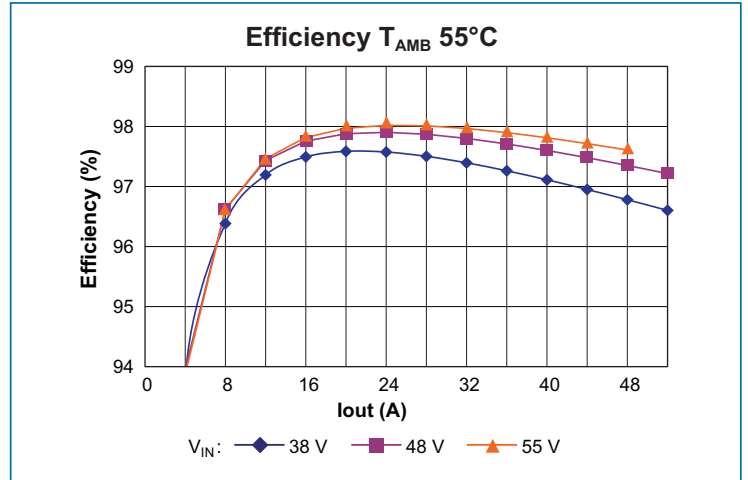

Figure 2 — Efficiency vs. output current, 55°C ambient

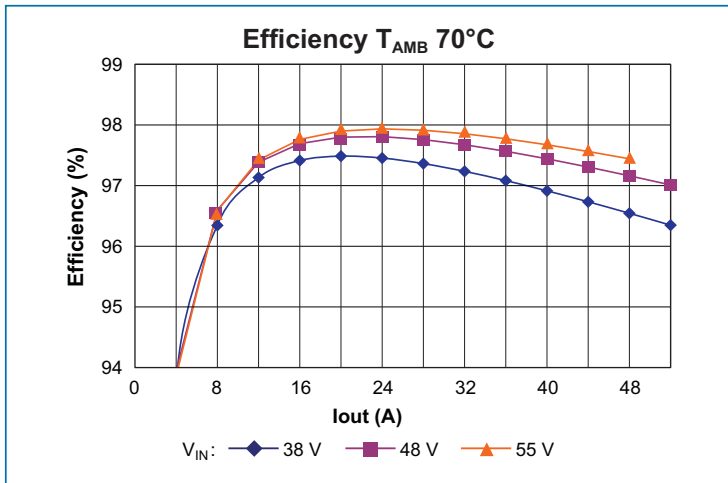

Figure 3 — Efficiency vs. output current, 70°C ambient

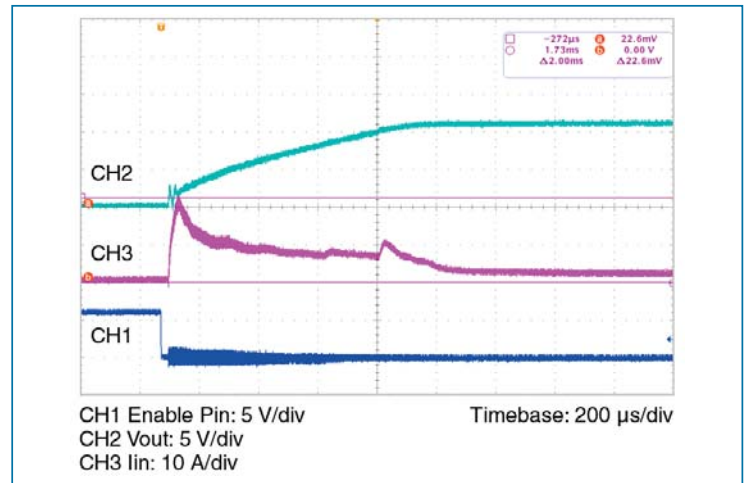

Figure 4 — Inrush current at nominal line full load; 10 A/div

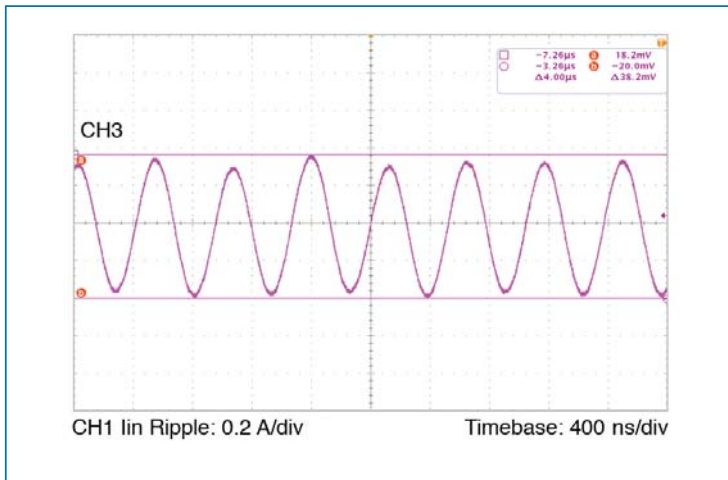

Figure 5 — Input reflected ripple current at nominal line, full load

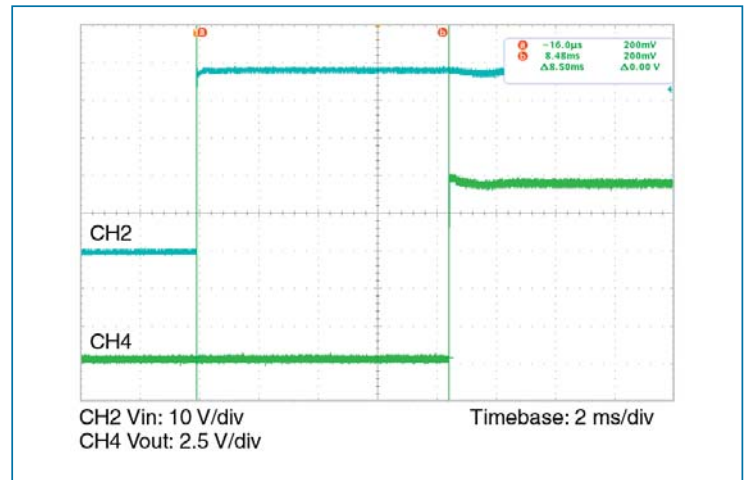

Figure 6 — Turn on delay time;  
 $V_{IN}$  turn on delay at nominal line, full load

# PRELIMINARY DATA SHEET

## SPECIFICATIONS (CONT.)

### WAVEFORMS (CONT.)

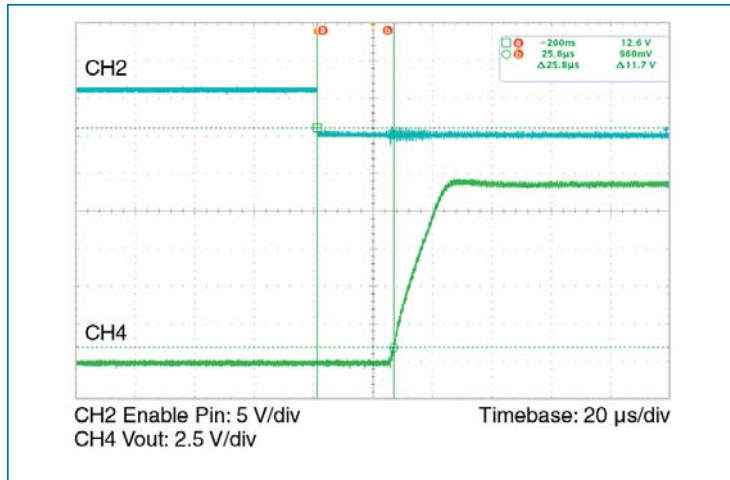

Figure 7 — Turn on delay time;  
Enable turn on delay at nominal line, full load

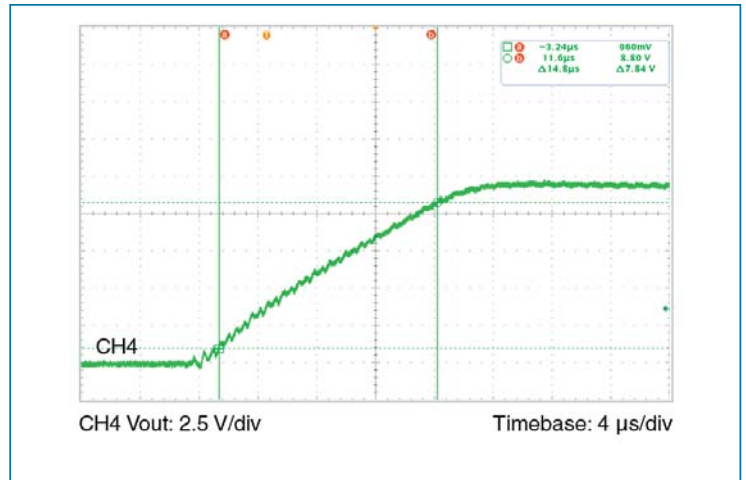

Figure 8 — Output voltage rise time at nominal line, full load

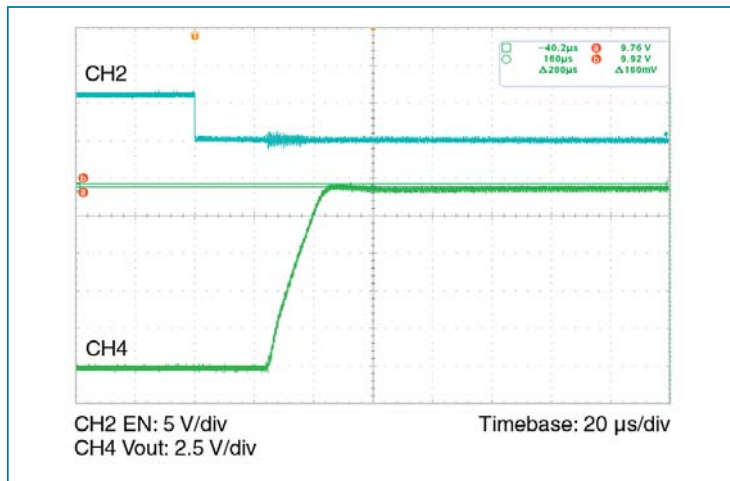

Figure 9 — Overshoot at turn on at nominal line, full load

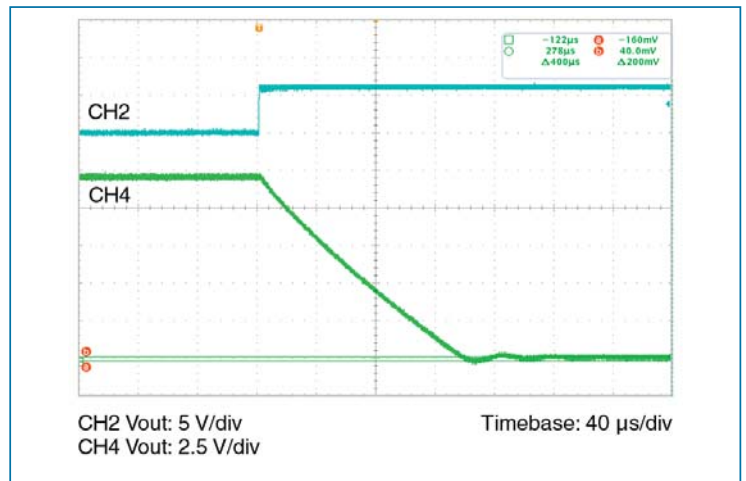

Figure 10 — Undershoot at turn off at nominal line, 10% load

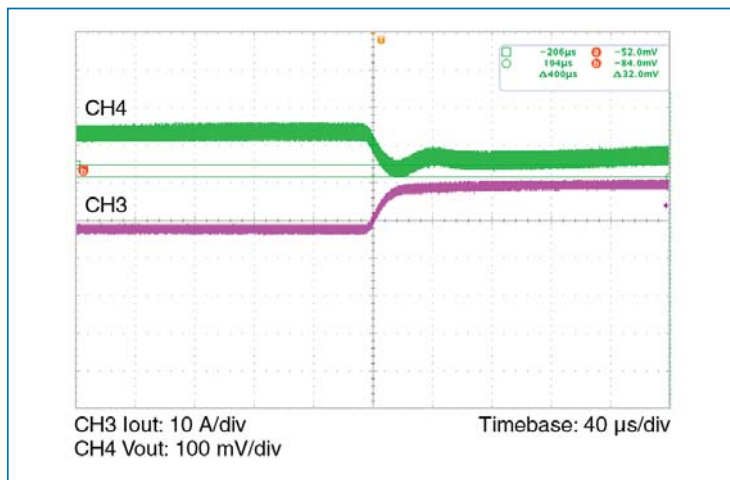

Figure 11 — Load transient response; nominal line  
Load step 75–100%; 10 A/div

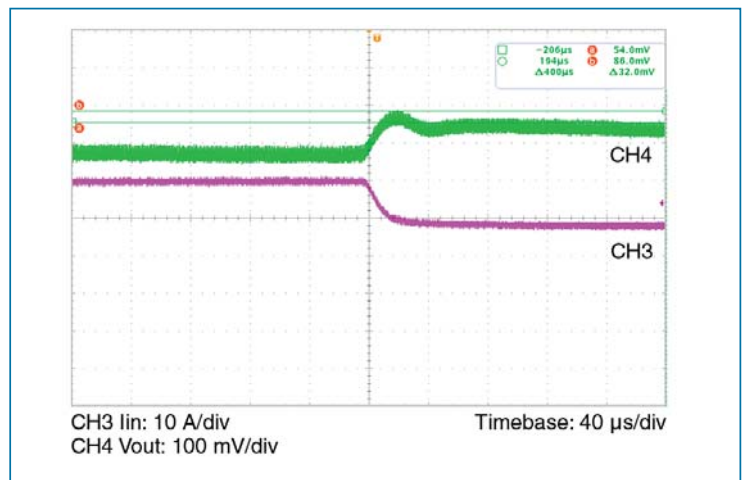

Figure 12 — Load transient response; Full load to 75%; nominal line

# PRELIMINARY DATA SHEET

## SPECIFICATIONS (CONT.)

### WAVEFORMS (CONT.)

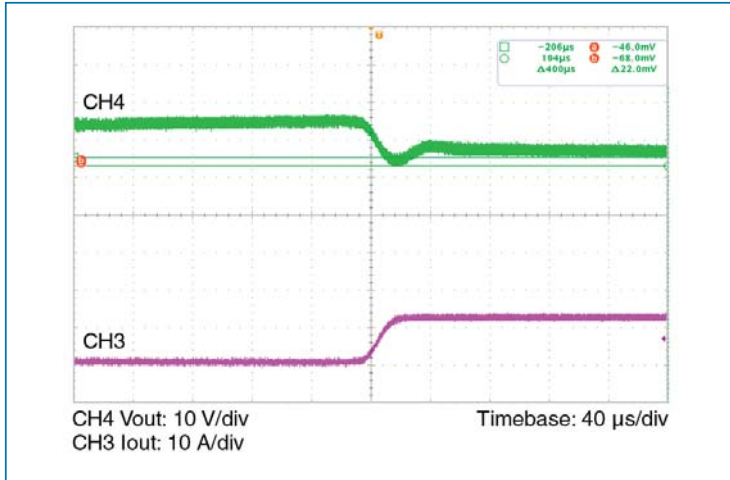

Figure 13 — Load transient response; nominal line  
Load step 0–25%; 10 A/div

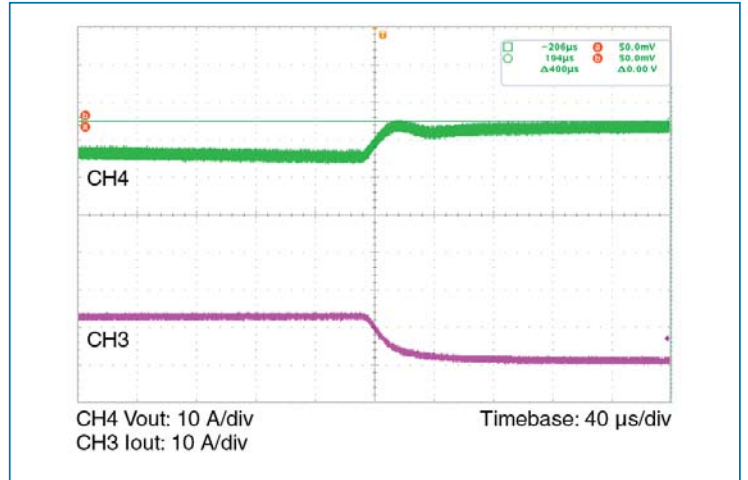

Figure 14 — Load transient response; 25–0%; nominal line

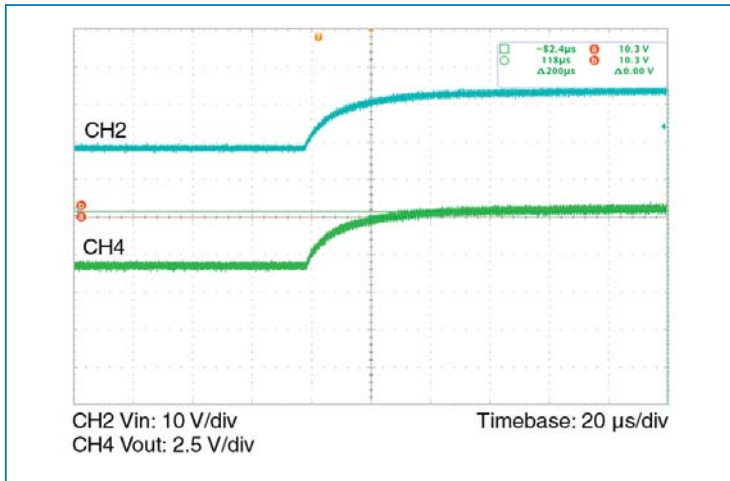

Figure 15 — Input transient response;  
Vin step low line to high line at full load

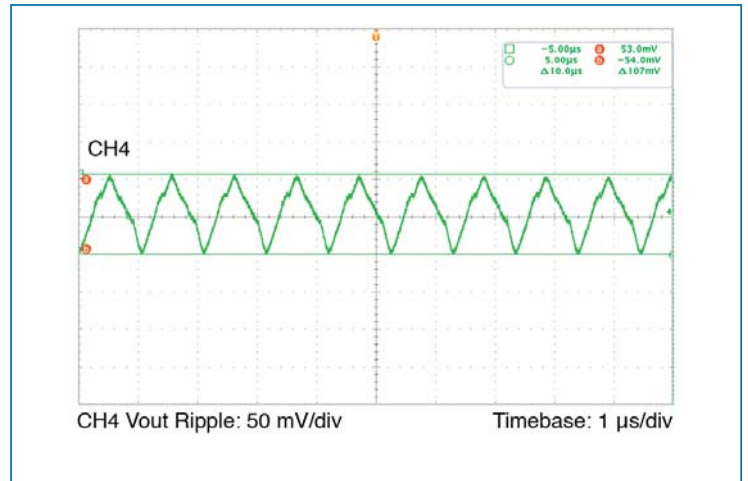

Figure 16 — Output ripple; Nominal line, full load

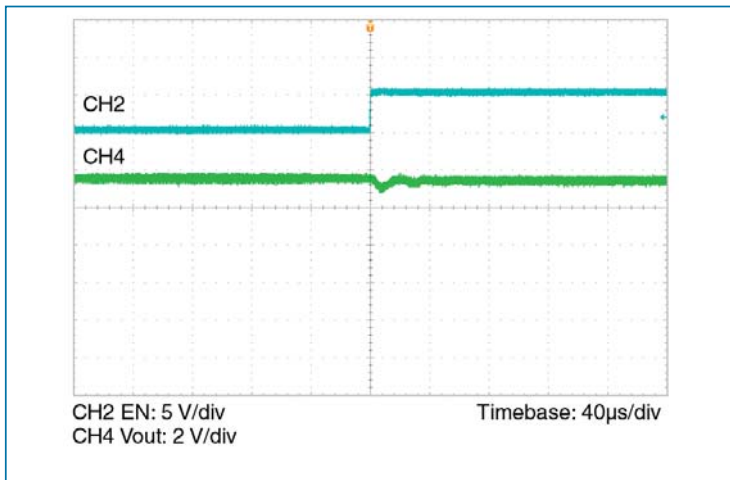

Figure 17 — Three module parallel array test. Vout change when one module is disabled. Nominal Vin, Iout = 96 A

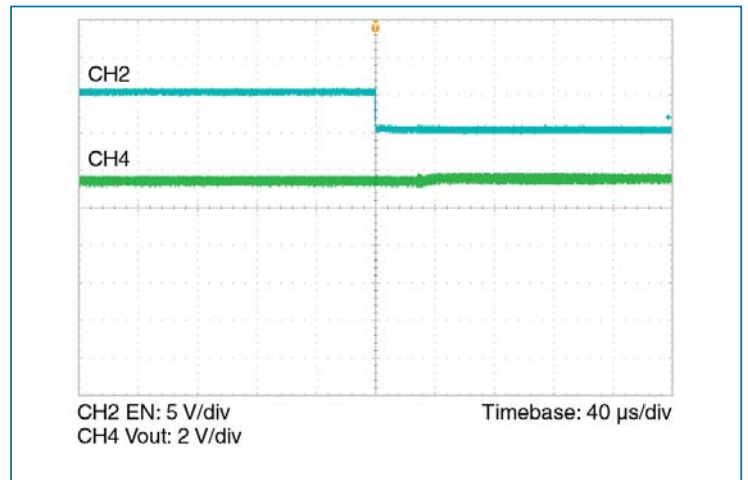

Figure 18 — Three module parallel array test. Vout change with two modules operating and a third module enabled. Nominal Vin, Iout = 96 A

SPECIFICATIONS (CONT.)

WAVEFORMS (CONT.)

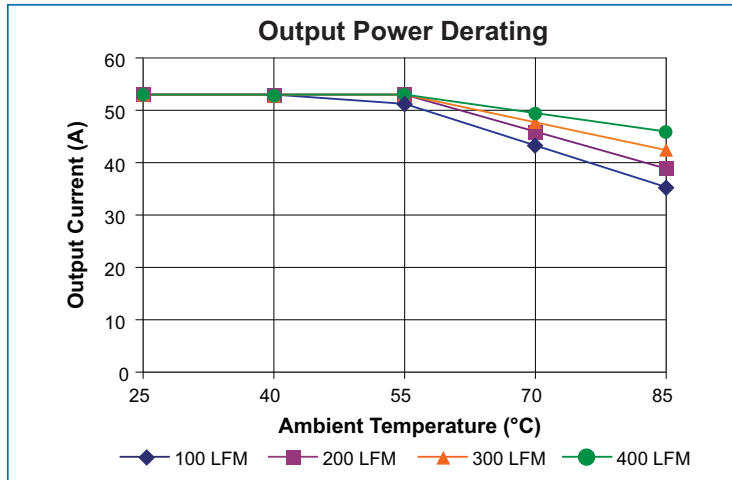

Figure 19 — Maximum output power derating vs ambient air temperature. Transverse airflow, Board and junction temperatures within IPC-9592 derating guidelines

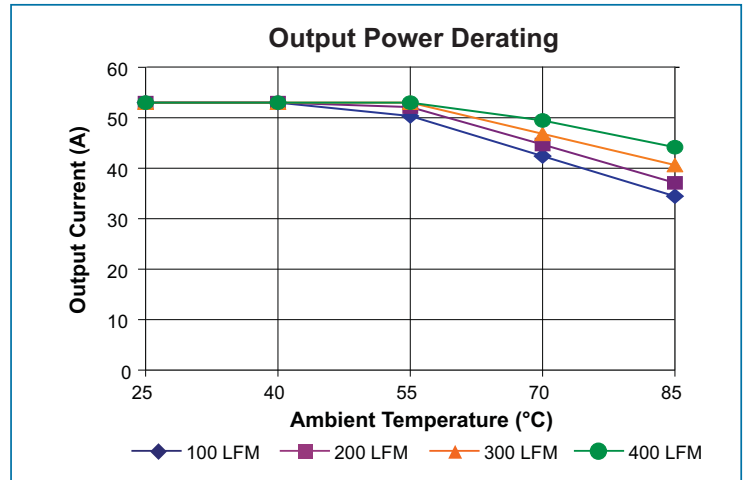

Figure 20 — Maximum output power derating vs ambient air temperature. Longitudinal airflow, Board and junction temperatures within IPC-9592 derating guidelines

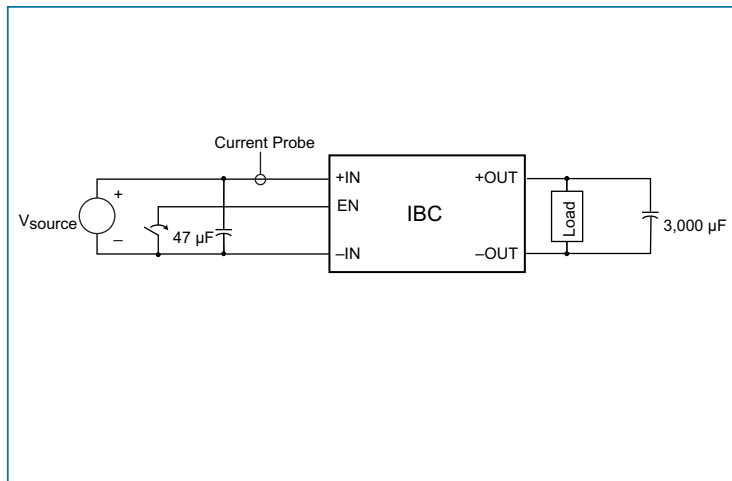

Figure 21 — Inrush current overshoot

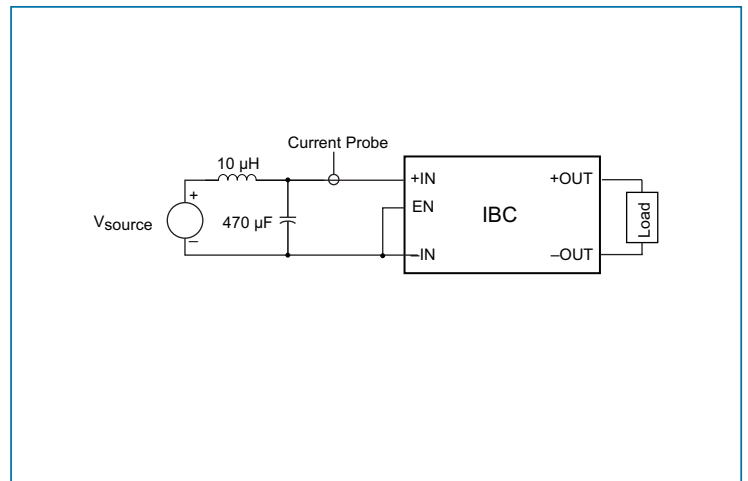

Figure 22 — Input reflected ripple current

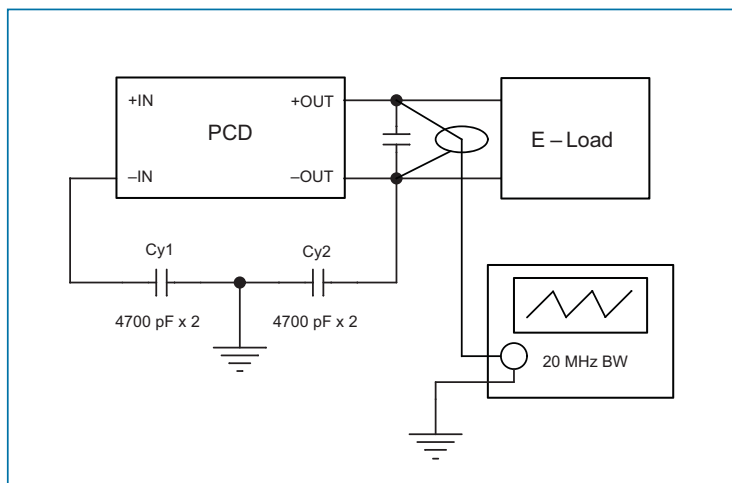

Figure 23 — Test circuit; output voltage ripple



SPECIFICATIONS (CONT.)

THERMAL DATA

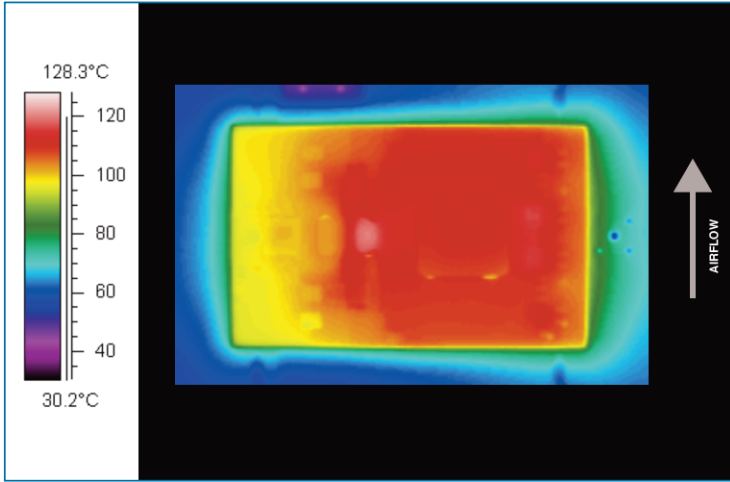

Figure 24 — Thermal plot, 200 LFM, 25°C, 48 Vin, 600 W output power

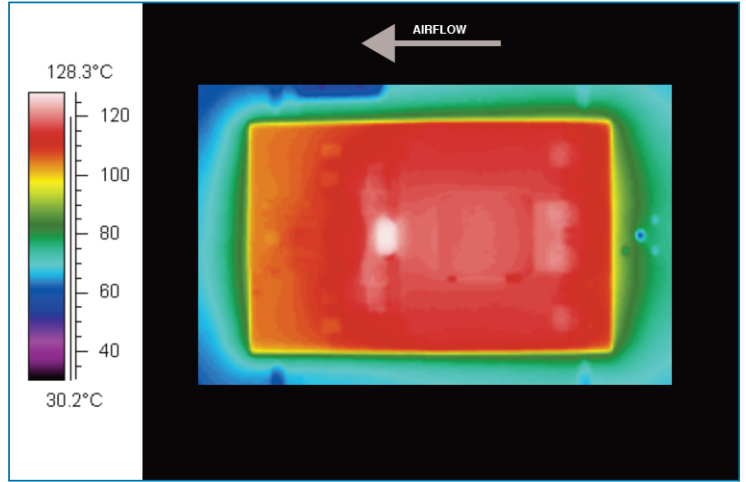

Figure 25 — Thermal plot, 200 LFM, 25°C, 48 Vin, 600 W output power

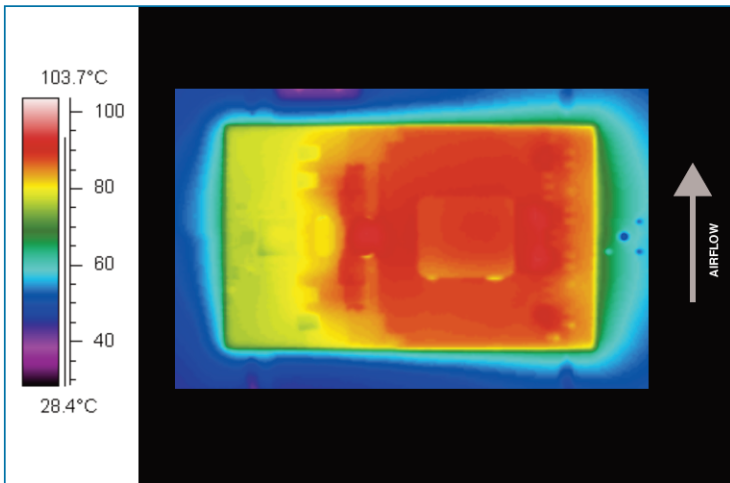

Figure 26 — Thermal plot, 400 LFM, 25°C, 48 Vin, 600 W output power

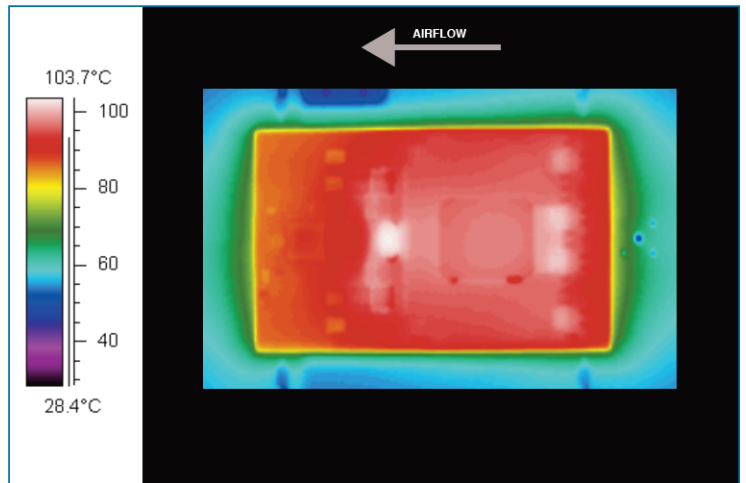

Figure 27 — Thermal plot, 400 LFM, 25°C, 48 Vin, 600 W output power

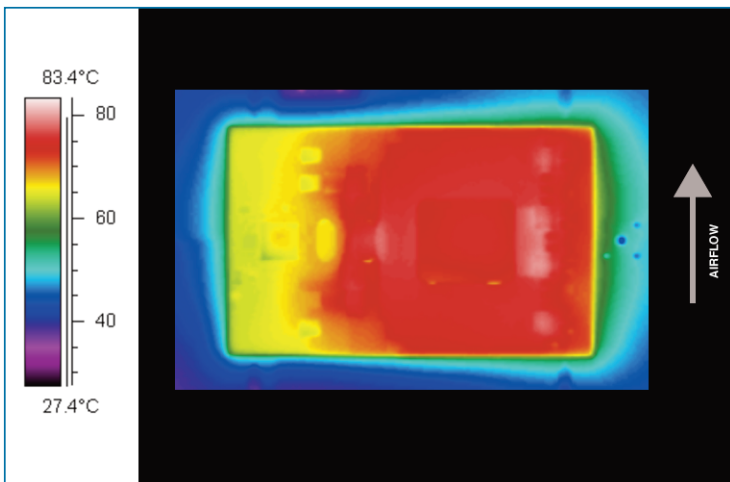

Figure 28 — Thermal plot, 600 LFM, 25°C, 48 Vin, 600 W output power

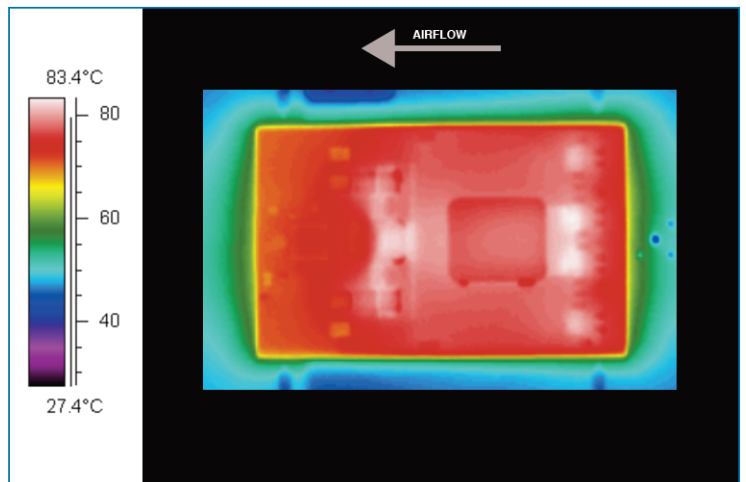

Figure 29 — Thermal plot, 600 LFM, 25°C, 48 Vin, 600 W output power

PIN / CONTROL FUNCTIONS

**+In / -In – DC Voltage Input Pins**

The IBC input voltage range should not be exceeded. An internal undervoltage/overvoltage lockout function prevents operation outside of the normal operating input range. The IBC turns on within an input voltage window bounded by the “Input under-voltage turn-on” and “Input over-voltage turn-off” levels, as specified. The IBC may be protected against accidental application of a reverse input voltage by the addition of a rectifier in series with the positive input, or a reverse rectifier in shunt with the positive input located on the load side of the input fuse.

The connection of the IBC to its power source should be implemented with minimal distribution inductance. If the interconnect inductance exceeds 100 nH, the input should be bypassed with a RC damper to retain low source impedance and stable operation. With an interconnect inductance of 200 nH, the RC damper may be 47  $\mu$ F in series with 0.3  $\Omega$ . A single electrolytic or equivalent low-Q capacitor may be used in place of the series RC bypass.

**EN – Enable/Disable**

If the EN port is left floating, the IBC output is disabled. Once this port is pulled lower than 0.8 Vdc with respect to -In, the output is enabled. The EN port can be driven by a relay, opto-coupler, or open collector transistor. Refer to Figures 6 and 7 for the typical enable / disable characteristics. This port should not be toggled at a rate higher than 1 Hz. The EN port should also not be driven by or pulled up to an external voltage source.

**+Out / -Out – DC Voltage Output Pins**

Total load capacitance at the output of the IBC should not exceed the specified maximum. Owing to the wide bandwidth and low output impedance of the IBC, low frequency bypass capacitance and significant energy storage may be more densely and efficiently provided by adding capacitance at the input of the IBC.

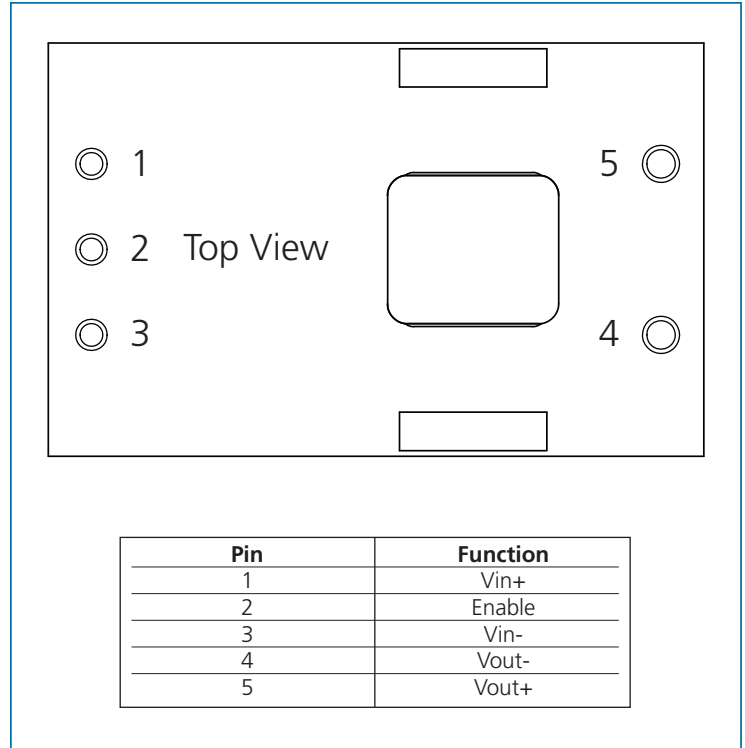

Figure 30 — IBC Pin Designations

## APPLICATIONS NOTE

---

### Parallel Operation

The IBC will inherently current share when operated in an array. Arrays may be used for higher power or redundancy in an application. Current sharing accuracy is maximized when the source and load impedance presented to each IBC within an array are equal. The recommended method to achieve matched impedances is to dedicate common copper planes within the PCB to deliver and return the current to the array, rather than rely upon traces of varying lengths. In typical applications the current being delivered to the load is larger than that sourced from the input, allowing narrower traces to be utilized on the input side if necessary. The use of dedicated power planes is, however, preferable.

One or more IBCs in an array may be disabled without adversely affecting operation or reliability as long as the load does not exceed the rated power of the enabled IBCs.

The IBC power train and control architecture allow bi-directional power transfer, including reverse power processing from the IBC output to its input. The IBC's ability to process power in reverse improves the IBC transient response to an output load dump.

### Thermal Considerations

The temperature distribution of the VI Brick can vary significantly with its input/output operating conditions, thermal management and environmental conditions. Although the PCB is UL rated to 130°C, it is recommended that PCB temperatures be maintained at or below 125°C.

For maximum long term reliability, lower PCB temperatures are recommended for continuous operation, however, short periods of operation at 125°C will not negatively impact performance or reliability.

**WARNING:** Thermal and voltage hazards. The IBC can operate with surface temperatures and operating voltages that may be hazardous to personnel. Ensure that adequate protection is in place to avoid inadvertent contact.

### Input Impedance Recommendations

To take full advantage of the IBC capabilities, the impedance presented to its input terminals must be low from DC to approximately 5 MHz. The source should exhibit low inductance and should have a critically damped response. If the interconnect inductance is excessive, the IBC input pins should be bypassed with an RC damper (e.g., 47  $\mu$ F in series with 0.3  $\Omega$ ) to retain low source impedance and proper operation. Given the wide bandwidth of the IBC, the source response is generally the limiting factor in the overall system response.

Anomalies in the response of the source will appear at the output of the IBC multiplied by its K factor. The DC resistance of the source should be kept as low as possible to minimize voltage deviations. This is especially important if the IBC is operated near low or high line as the overvoltage/undervoltage detection circuitry could be activated.

### Input Fuse Recommendations

The IBC is not internally fused in order to provide flexibility in configuring power systems. However, input line fusing of VI Bricks must always be incorporated within the power system. A fast acting fuse should be placed in series with the +In port.

### Application Notes

For IBC and VI Brick application notes on soldering, thermal management, board layout, and system design visit [vicorpower.com](http://vicorpower.com).

# PRELIMINARY DATA SHEET

## MECHANICAL DRAWINGS

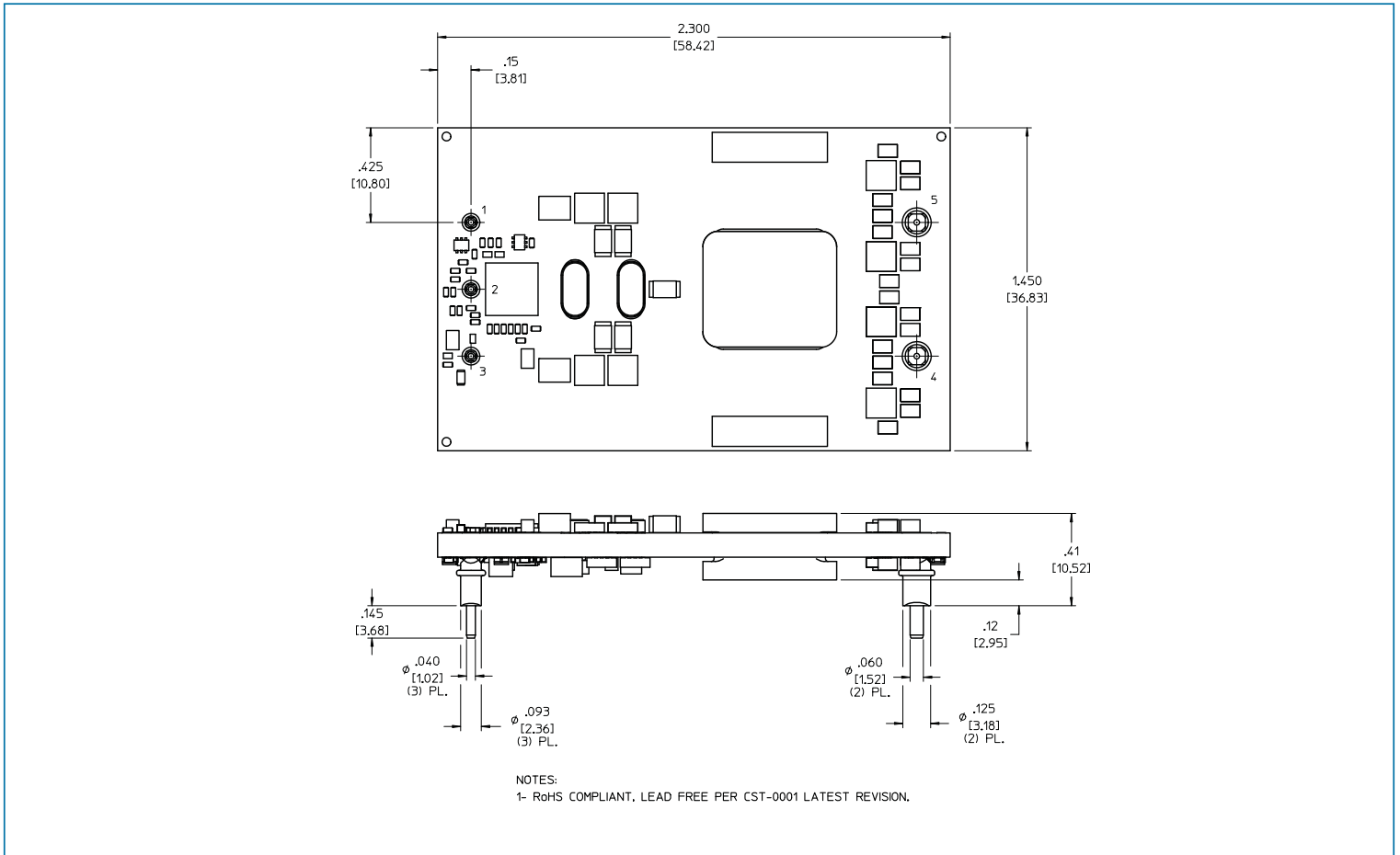

Figure 31 — IBC outline drawing

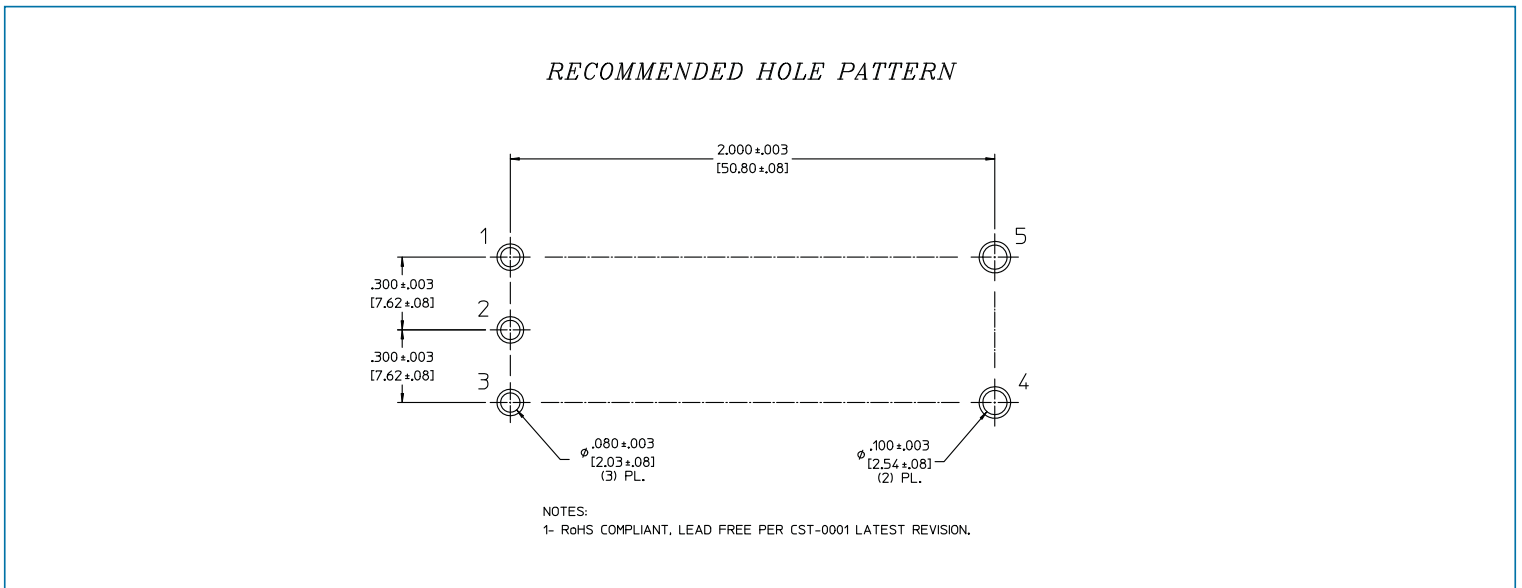

Figure 32 — IBC PCB recommended hole pattern

## Warranty

Vicor products are guaranteed for two years from date of shipment against defects in material or workmanship when in normal use and service. This warranty does not extend to products subjected to misuse, accident, or improper application or maintenance. Vicor shall not be liable for collateral or consequential damage. This warranty is extended to the original purchaser only.

EXCEPT FOR THE FOREGOING EXPRESS WARRANTY, VICOR MAKES NO WARRANTY, EXPRESS OR IMPLIED, INCLUDING, BUT NOT LIMITED TO, THE WARRANTY OF MERCHANTABILITY OR FITNESS FOR A PARTICULAR PURPOSE.

Vicor will repair or replace defective products in accordance with its own best judgement. For service under this warranty, the buyer must contact Vicor to obtain a Return Material Authorization (RMA) number and shipping instructions. Products returned without prior authorization will be returned to the buyer. The buyer will pay all charges incurred in returning the product to the factory. Vicor will pay all reshipment charges if the product was defective within the terms of this warranty.

Information published by Vicor has been carefully checked and is believed to be accurate; however, no responsibility is assumed for inaccuracies. Vicor reserves the right to make changes to any products without further notice to improve reliability, function, or design. Vicor does not assume any liability arising out of the application or use of any product or circuit; neither does it convey any license under its patent rights nor the rights of others. Vicor general policy does not recommend the use of its components in life support applications wherein a failure or malfunction may directly threaten life or injury. Per Vicor Terms and Conditions of Sale, the user of Vicor components in life support applications assumes all risks of such use and indemnifies Vicor against all damages.

## **Vicor's comprehensive line of power solutions includes high density AC-DC and DC-DC modules and accessory components, fully configurable AC-DC and DC-DC power supplies, and complete custom power systems.**

Information furnished by Vicor is believed to be accurate and reliable. However, no responsibility is assumed by Vicor for its use. Vicor components are not designed to be used in applications, such as life support systems, wherein a failure or malfunction could result in injury or death. All sales are subject to Vicor's Terms and Conditions of Sale, which are available upon request.

## **Specifications are subject to change without notice.**

## Intellectual Property Notice

Vicor and its subsidiaries own Intellectual Property (including issued U.S. and Foreign Patents and pending patent applications) relating to the products described in this data sheet. Interested parties should contact Vicor's Intellectual Property Department.

The products described on this data sheet are protected by the following U.S. Patents Numbers: 5,945,130; 6,403,009; 6,710,257; 6,911,848; 6,930,893; 6,934,166; 6,940,013; 6,969,909; 7,038,917; 7,166,898; 7,187,263; 7,361,844; D496,906; D505,114; D506,438; D509,472; and for use under 6,975,098 and 6,984,965

**Vicor Corporation**  
25 Frontage Road  
Andover, MA, USA 01810  
Tel: 800-735-6200  
Fax: 978-475-6715

### email

Customer Service: [custserv@vicorpower.com](mailto:custserv@vicorpower.com)  
Technical Support: [apps@vicorpower.com](mailto:apps@vicorpower.com)